



BOSCH

AMC2 Extension

AMC2-4WE

en

Installation Manual

Table of contents

1	Safety Instructions	4
1.1	Important Safety Notes	4
1.2	Safety Precautions	5
1.3	Unpacking	6
2	Important Information	7
2.1	Explanation of symbols in this document	7
2.2	Internet	7
3	Introduction	8
3.1	Description	8
3.2	Equipment Configuration	9
3.3	Performance Characteristics	10
3.4	System Overview	10
4	Installing	12
4.1	Mounting	12
4.2	Unmounting	13
4.3	Opening the Case	14
4.4	Closing the Case	15
4.5	Cabling	15
4.5.1	Conductor data for power to AMC2	15
4.6	Grounding and Shielding	17
4.6.1	Grounding for Extension Interface	17
4.7	Connecting Power Supply	18
4.7.1	Direct Power Supply	18
4.7.2	Power Supply via RS-485 Interface	18
4.7.3	Overview - Power supply/consumption	19
4.8	RS-485 for extension modules	21
4.9	Wiegand Interface for Card Readers	22
4.10	Connecting Relay Outputs	22
4.11	Connecting Analog Input Devices	26
4.12	Tamper Protection	28
5	Operating	29
5.1	Status Display of the AMC2	29
6	Technical Data	31
7	Appendices	33
7.1	Connecting Diagrams	33
	Index	36

1 Safety Instructions

1.1 Important Safety Notes

1. **Read, follow, and retain instructions** - All safety and operating instructions must be read and followed properly before putting the unit into operation. Retain instructions for future reference.
2. **Do not ignore warnings** - Adhere to all warnings on the unit and in the operating instructions.
3. **Accessories** - Use only accessories recommended by the manufacturer or those sold with the product. Accessories not recommended by the manufacturer must not be used, as they may cause hazards.
4. **Installation precautions** - Do not place this unit on an unstable stand, tripod, bracket, or mount. The unit may fall, causing serious injury to persons and damage to the unit. Mount the unit according to the manufacturer's instructions.
5. **Service** - Do not attempt to service this unit by yourself. Opening or removing covers may expose you to dangerous voltages or other hazards. Refer all servicing to qualified service personnel.
6. **Damage which requires service** - Disconnect the unit from the main AC or DC power source and refer servicing to qualified service personnel under the following conditions:
 - If the power supply cord or plug is damaged.
 - If liquid has been spilled or an object has fallen into the unit.
 - If the unit has been exposed to water and/or inclement weather (rain, snow, etc.).
 - If the unit does not operate normally when following the operating instructions. Adjust only those controls specified in the operating instructions. Improper adjustment of other controls may result in damage, and require extensive work by a qualified technician to restore the unit to normal operation.
 - If the unit has been dropped or the cabinet damaged.
 - If the unit exhibits a distinct change in performance.
7. **Replacement parts** - If replacement parts are required, the service technician must use only replacement parts that are specified by the manufacturer. Unauthorized replacements may result in fire, electrical shock or other hazards.
8. **Safety check** - Upon completion of service or repair work on the unit, ask the service technician to perform safety checks to ensure that the unit operates properly
9. **Power sources** - Operate the unit only from the type of power source indicated on the label. If unsure of the type of power supply to use, contact your dealer
10. **Lightning** - For added protection during electrical storms external lightning conductors can be installed. This prevents power surges from damaging the unit.
11. The units should be installed in **locations with restricted access**.

1.2 Safety Precautions

Read instructions!

Before working with the AMC2 device, read these instructions carefully. Make sure you have understood all information described in this document.



Warning!

Risk of electric shock

External power supplies must be installed and put into service by qualified personnel. Ensure compliance with the relevant regulations. Ground the controller. Disconnect both AC and battery power supply before working on the controller.



Warning!

Risk of fire

Installation of the AMC2 device must comply with any local fire, health, and safety regulations. A secured door that may be part of an escape route from an area must be installed with:
 Install a fail-safe lock (A), so that the door will be released if power fails. Ideally, use a magnetic lock.
 Install a normally-closed break glass or a manual pull (B) in the lock supply wiring, so that in an emergency the fail-safe lock can be immediately powered down.



Warning!

Risk of explosion of Lithium battery

The battery can explode if it is replaced incorrectly. Replace only with the same type as recommended by the manufacturer. Dispose used batteries according to the battery manufacturer's instructions.



Notice!

Risk of damage to equipment

Protect the hardware from electrostatic discharge by observing ESD instructions before unpacking of touching connectors of electronics. Always switch off power of the AMC2 device before modifying the installation. Do not connect or disconnect plug connectors, data cables, or screw connectors while power is on.

Rules and Conditions

There are no specific requirements as for selling and delivery. As for storage and safe operation, the environmental temperature should not exceed the range of 0°C to 50°C.

Disposal

Your Bosch product is designed and manufactured with high-quality materials and components which can be recycled and reused.



This symbol means that electrical and electronic equipment, at their end-of-life, should be disposed of separately from your household waste.

In the European Union, there are separate collection systems for used electrical and electronic products. Please dispose of this equipment at your local community waste collection/recycling center.

1.3 Unpacking

Check the packaging for visible damage. If anything has been damaged during transport, please inform the transport agency.

Unpack the unit carefully. This is an electronic device that must be handled with care to avoid damage. Do not attempt to put the unit into operation if components are damaged.

If any parts are missing, inform your customer service representative or a Bosch Security Systems salesperson. The shipping carton is the safest transport container for the unit. Store it and the other packaging material for future use. If the unit has to be sent back, use the original packaging.

2 Important Information

Remarks

This hardware is part of a security system. Access should be limited to authorized persons only.

Some states do not allow the exclusion or limitation of implied warranties, or limitation of liability for incidental or consequential damages, hence the above limitation or exclusion might not apply to you.

Bosch Security Systems retains all rights not expressly granted. Nothing in this license constitutes a waiver of Bosch's rights under the U.S. Copyright laws or any other federal or state law.

If you have any questions concerning this license, please, write to:

Bosch Sicherheitssysteme GmbH
Robert-Bosch-Ring 5
85630 Grasbrunn
Germany.

2.1 Explanation of symbols in this document

Throughout this document, warning messages, important notes, and helpful tips are presented for the reader. These appear as follows:



Danger!

Cause of Hazard

Indicates a hazardous situation, which, if not avoided, will result in death or serious injury.



Warning!

Cause of Hazard

Indicates a hazardous situation, which, if not avoided, could result in death or serious injury.



Caution!

Cause of Hazard

Indicates a hazardous situation, which, if not avoided, could result in minor or moderate injury.



Notice!

Cause of Hazard

Important Notes that must be followed to avoid damage to the equipment or environment, and to ensure successful operation and programming.

Tips and shortcuts may also be included in such notes.

2.2 Internet

If you are interested in further information on this product or information on other products, please consult our website at <http://www.boschsecurity.com>.

3 Introduction

3.1 Description

The extension module AMC2-4WE is equipped with four Wiegand type reader-interfaces plus eight inputs and eight outputs. Hence with the AMC2-4WE it is possible to double the number of readers on an AMC2-4W from 4 to 8.

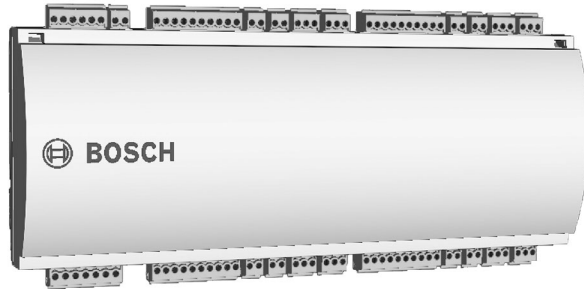

Figure 3.1: The extension module AMC2-4WE

The AMC2-4WE can not be deployed as an independent controller but only as an extension module for the AMC2-4W. Control and access decisions and bookings are carried out by the AMC2-4W alone.

**Notice!**

The AMC2-4WE can only be used with AMC2-4W. As it provides Wiegand interfaces it cannot be coupled with an AMC2-4R4.

The AMC2-4W can be extended by a maximum of one AMC2-4WE plus a maximum of three I/O extension modules. The I/O extension modules AMC2-8IOE/AMC2-16IOE (in any combination) are, like the AMC2-4WE, connected via the AMC2-4W's extension interface.

**Notice!**

The AMC2-4WE has no display. The information about the input and outputs will be shown on special pages of the AMC2 display.

As the extension modules contain neither memory nor display they are controlled and monitored entirely by the AMC2-4W.

The AMC2-4W can have an additional interface extension module AMC2-4WE, so that the number of inputs and outputs can grow up to 64.

**Notice!**

An AMC2-4WE provides signals only to the AMC2 to which it is connected. Signal transfer to another AMC2 is not possible.

The signal settings and parametrization of the readers connected to the extension module, are carried out by the configuration applications in the access control system and by the AMC2-4W to which it belongs.

3.2 Equipment Configuration

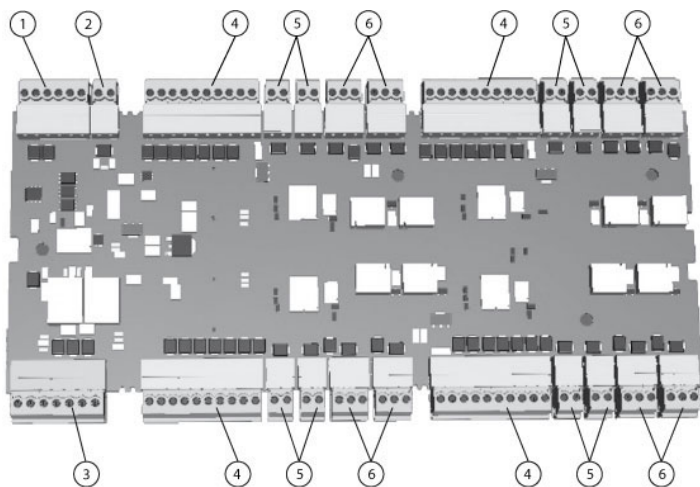

Figure 3.2: Overview - Interfaces

1	RS-485 extension module bus
2	External tamper contact
3	Connector for power supply
4	Wiegand interfaces for up to 8 card readers
5	Connectors for eight analog inputs
6	Connectors for eight relay outputs

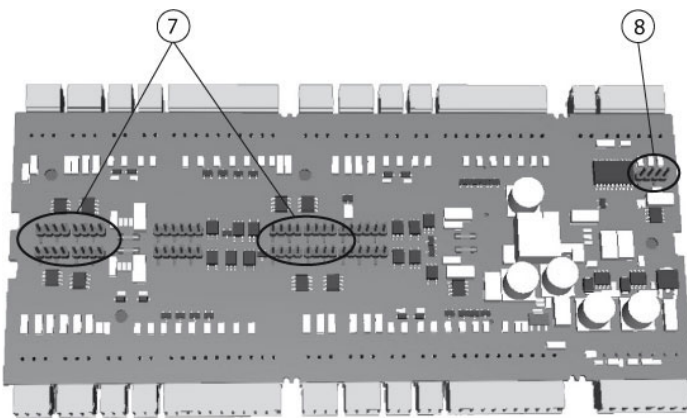

Figure 3.3: Jumpers at the bottom side

7	Jumper for setting either voltage free relay output (“dry” mode) or looped-in voltage from the AMC2 internal power supply (“wet” mode).
8	Jumper: Equalization of potential between different systems and earth ground (shield) for the extension interface.

3.3 Performance Characteristics

- Controlled by an AMC2 via RS-485
- Reader interfaces
 - four two Wiegand interfaces
- Eight relay outputs
 - voltage free, power is supplied externally (dry mode)
 - powered by internal power supply (wet mode)
- Eight analog inputs with internal power supply
- Transfer rate to the extension interface: 9,6 kBit/s
- Self regulating transmit/receive switching
- Power supply:
 - 10V - 30Vdc - max. 5 A
 - or over the RS-485 host connector
- Information about the inputs and outputs on the display of the AMC2 controller
- Tamper contact for external covers



Notice!

If an external power supply is used, this should also guarantee an uninterruptable power supply (UPS). Example: Bosch power supply APS-PSU-60 (F.01U.282.970).

3.4 System Overview

The AMC2-4WE is connected between the access controller AMC2-4W and the various peripheral devices.

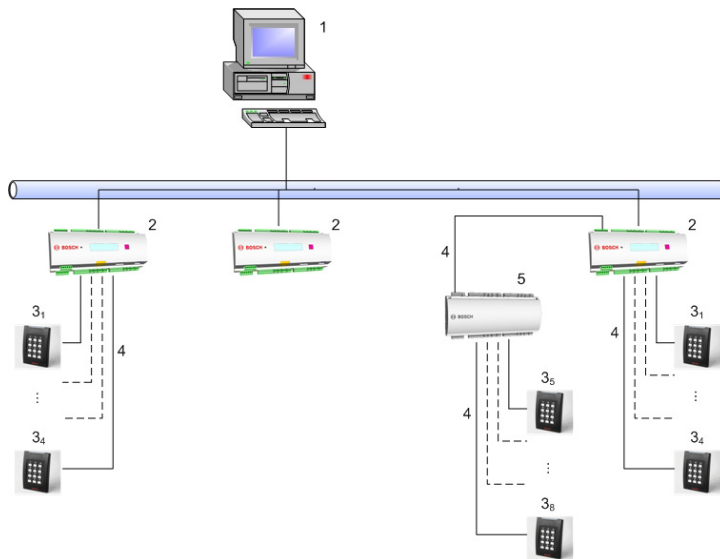

Figure 3.4: System overview

1 =	Host
2 =	AMC2-4W
3 =	Card reader
4 =	Communication and power supply
5 =	AMC2-4WE

System configurations for Access Control applications.

- The minimum configuration consists of:
 - one PC with system software,
 - one AMC2 controller,
 - one AMC power supply,
 - one AMC enclosure.
- The maximum configuration depends on the system software,
- Each AMC2-4W controller can be extended with an AMC2-4WE extension module.

The using of AMC2-4WE modules has no influence on the limit of the maximum of controllers in one system, because it is an extension to an AMC2-4W and not a controller.

Using Wiegand reader interfaces, up to four peripheral devices can be connected to each AMC2-4R4. The interfaces are point-to-point connections, meaning that only one reader can be connected to one interface.

4 Installing



Notice!

To build an UL approved system refer the documentation contained in the folder titled "_UL" on the delivered CD.

4.1 Mounting

The AMC2-4R4 can be attached on a standard 35 mm (1.377 in.) mounting rail using a snap-in mechanism. Attach the AMC2-4R4 into the upper edge of the mounting rail [1], then push down the device and snap it onto the rail by pushing it towards the back [2].

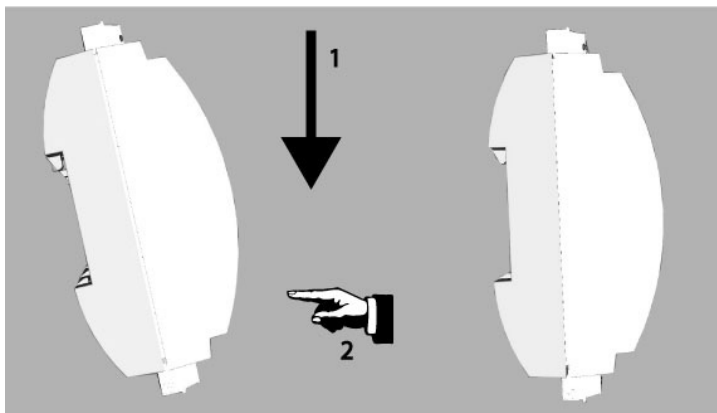

Figure 4.1: Mounting the AMC2 device on a mounting rail

4.2 Unmounting

**Notice!**

To remove the AMC2-4R4 from a mounting rail, first remove all pluggable connectors.

Push down the AMC2-4R4 until the lower edge snaps out of the mounting rail [1]. Pull the lower end of the AMC2-4R4 from the mounting rail [2].

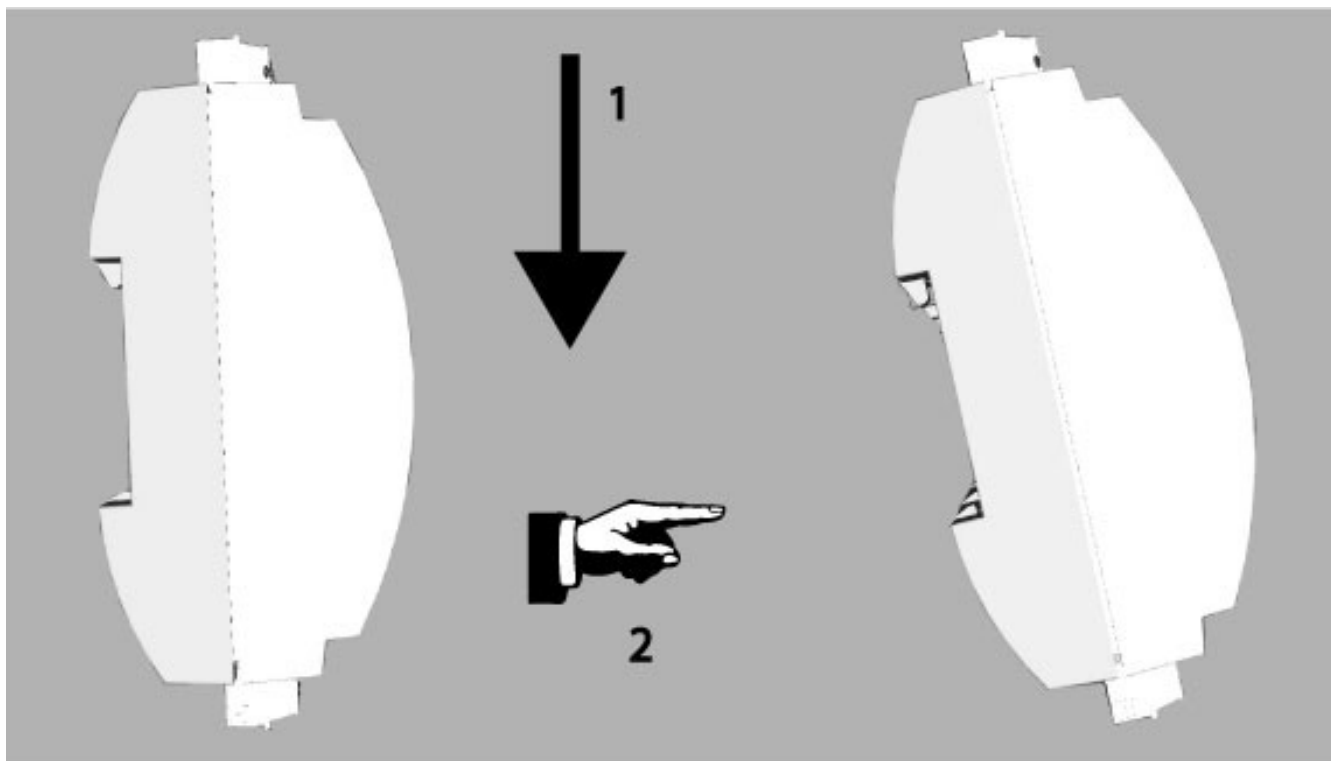

Figure 4.2: Unmounting the AMC2 device from a mounting rail

4.3 Opening the Case

**Notice!**

To open the AMC2-4R4, first remove all pluggable connectors.

The AMC2-4R4 case consists of a top cover mounted with a two-point snap-in closure on a chassis. To open the case, push down the two snap-ins with a screwdriver, then swing the cover down.

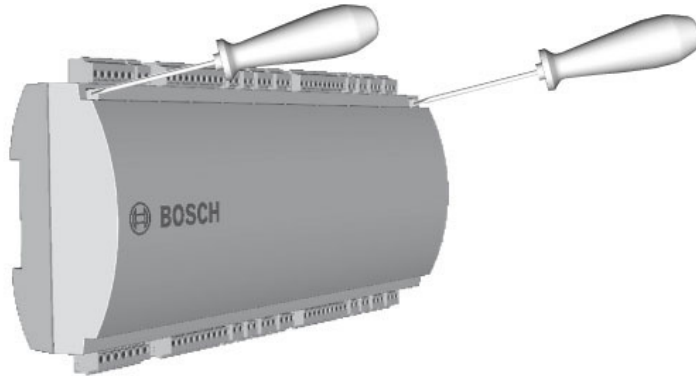

Figure 4.3: Opening the AMC2-4WE case

4.4 Closing the Case

Before aligning the covers, unplug any pluggable screw connectors. Insert the hooks on the lower edge of the front cover into the lugs on lower edge of the plastic back cover [1]. Please ensure that the BOSCH logo is not upside-down. The upper edge of the front cover now aligns with the two-point snap-in closures on the upper edge of the back cover [2], and may thus be clicked gently into place.

Hence the closing process is the reverse of the opening process.

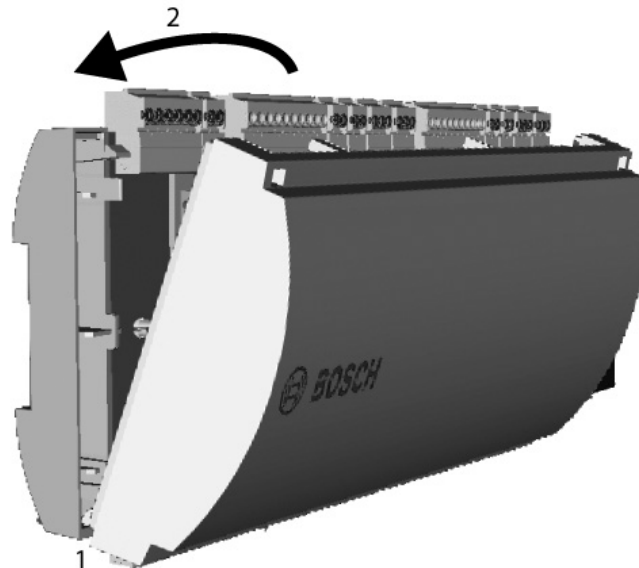

Figure 4.4: Closing the extension case



Notice!

Risk of damage to equipment

If excessive force is required to close the front cover then it is probably incorrectly hooked into the back cover. In such cases the display 'Dialog' button in the front cover will be misaligned and will not function correctly.

4.5 Cabling



Notice!

Risk of malfunction

The cables used in the AMC2-4R4 access control system are not prone to electrical interference. However, you should avoid routing cables close to heavy load switching cables and equipment. If this is unavoidable, cross the cable at right angles every 1 to 2 m (3 to 6 ft) to reduce interference.

4.5.1 Conductor data for power to AMC2

With the calculation below you can find out which cable type must be used. If you connect the power supply and the AMC-device with the delivered cable set from the enclosure the calculation is not necessary.

For distances below 25 m (75 ft) use AWG18 conductors (1mm²). For longer distances, install an additional power supply close to the AMC2 controller.

Please, calculate the voltage drop by checking the conductor specifications for characteristic resistance values. The voltage drop shall not exceed 2 V.

Example:

Length = 100 m/328 ft

U = 12V, I = 1A, maximum $U_{\text{Drop}} = 2\text{V}$

i.e. RAWG18 (acc. specs) = $6.385 \frac{\Omega}{1000 \text{ ft}}$ or $20,948 \frac{\Omega}{\text{km}}$

$U_{\text{Drop}} = 20,948 \frac{\Omega}{\text{km}} \times 0.1 \text{ km} \times 1\text{A} = 2.1\text{V}$

$U_{\text{Drop}} = 6.385 \frac{\Omega}{1000 \text{ ft}} \times 328 \text{ ft} \times 1\text{A} = 2.1\text{V}$

Critical condition! Install the power supply closer to the controller.



Notice!

These specifications apply to power supply, readers, relay outputs, and extension interface. Regarding inputs, specific voltage-drop values need to be taken into account. Refer to *Connecting Analog Input Devices*, page 26.

4.6 Grounding and Shielding

The AMC2 controller allows you to create a central ground or shielding point, simply by setting certain jumpers. Set these jumpers only if grounding or shielding is not achieved by other means.

1. If the AMC2-4R4 has its own power - as in the third example in *Overview - Power supply/consumption, page 19* - the shield will be connected to pin 2 of the power supply connector - see *Connecting Diagrams, page 33*.
2. If the extension module is powered from the AMC2 controller - as in the second example in *Overview - Power supply/consumption, page 19* - the connection should be made as in the *RS-485 for extension modules, page 21* diagram.
3. If more than one extension module is to be connected to an AMC2 controller, and all of them to receive power from it as well, then use the RS-485 extension interface for the connection.



Notice!

In the second and third case the jumper on the bottom side of the AMC2-controller must to be set - see the installation manual of the AMC2-4W.



Notice!

Risk of malfunction
Ensure that no ground loops are formed.



Notice!

In general the following apply:
If the devices have their own power supplies, the shielding is applied to one side only. The free end should be insulated to avoid inadvertent connections.
If one device is fed power by another, the cable shielding should be applied to both sides.

4.6.1 Grounding for Extension Interface

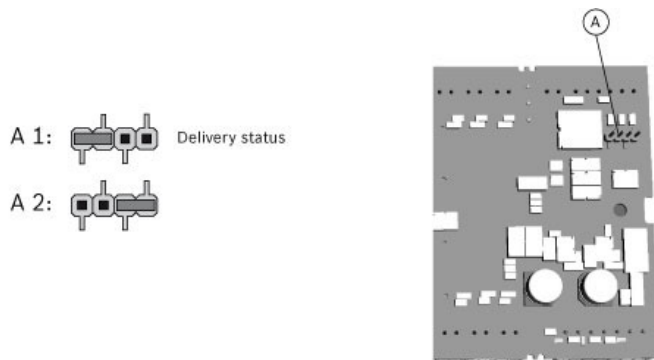

Figure 4.5: Location of ground jumper bottom side

The jumper setting A1 shows the factory settings.
Jumper connects the internal ground of the AMC2-4R4 to the ground of the RS-485 slave interface. Set Jumper A2 only at the first AMC2-4R4 of a party line *Overview - Power supply/consumption, page 19*.

4.7 Connecting Power Supply

4.7.1 Direct Power Supply

Connect the power supply to the POWER 7-pin pluggable screw connector. Refer to *Connecting Diagrams*, page 33 for a complete diagram.

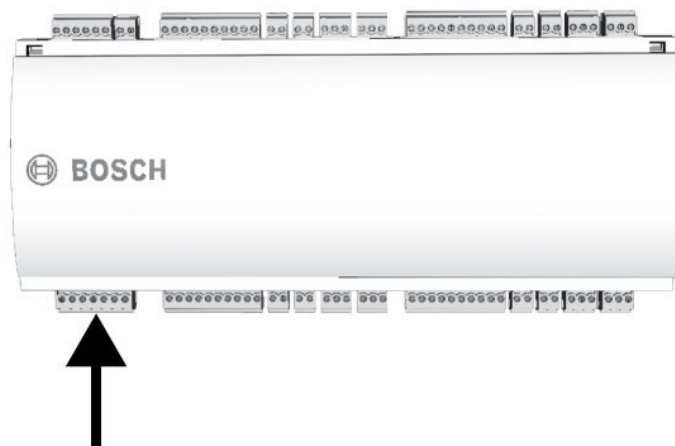

Figure 4.6: Location of the power supply connector

Connect an external power supply (10 - 30 Vdc) for AMC2-4R4 at pin 1 (positive) and pin 3 (0 V) of the pluggable screw connector.

If an uninterruptible power supply (UPS) is used, the relay output for power good signals from the UPS is connected to the following pins:

- pin 4 and 7 for power good AC
- pin 5 and 7 for power good Battery
- pin 6 and 7 for power good DC

Otherwise these pins must be short-circuited.

4.7.2 Power Supply via RS-485 Interface

The power can also be supplied by the AMC2-4W. In this case power pins 1 and 2 should be connected, as well as data lines on pins 3 - 6.



Figure 4.7: Interface for internal power supply

4.7.3 Overview - Power supply/consumption

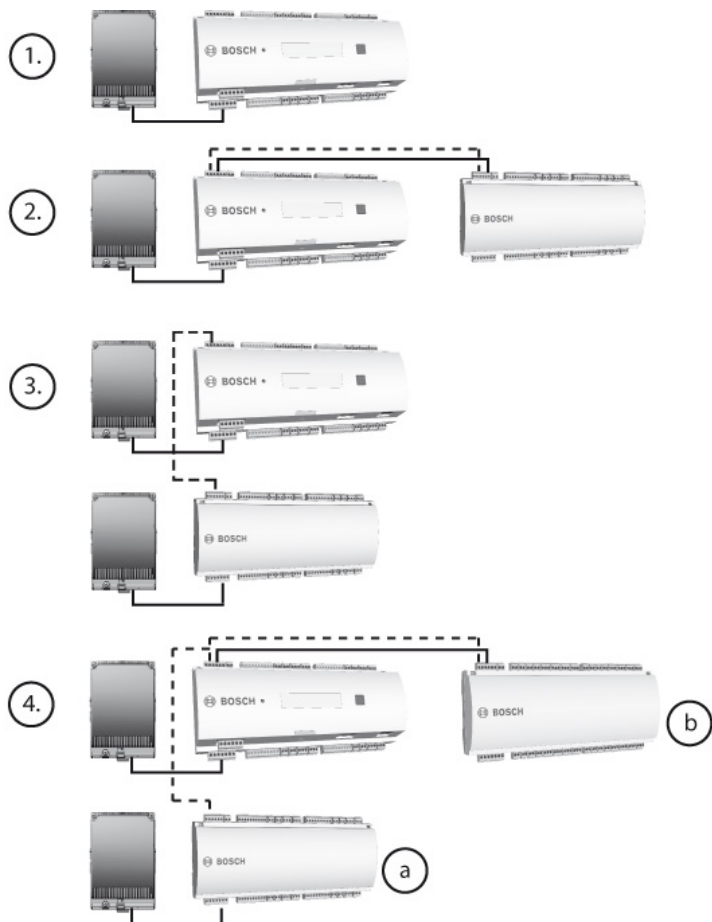

Figure 4.8: Example configurations

a	= AMC2-4WE
b	= AMC2 I/O Extension board
line	= Power supply
broken line	= Data line

Example	Components used	Output power	Consumption	Available	Constant load
1	PS + AMC2-4W	60VA	5VA	55VA	25VA
2	PS + AMC2-4W + AMC2-4WE	60VA	2 x 5VA	50VA	20VA
	PS + AMC2-4W + AMC2-4WE + Extension	60VA	3 x 5VA	45VA	15VA
3	PS + AMC2-4W	60VA	5VA	55VA	25VA
	and PS + AMC2-4WE	+ 60VA	+ 5VA	+ 55VA	+ 25VA
	PS + AMC2-4W and	60VA + 60VA	5VA + 2 x 5VA	55VA + 50VA	25VA + 20VA

Example	Components used	Output power	Consumption	Available	Constant load
	PS + AMC2-4WE + Extension				
4	PS + AMC2-4W + Extension and PS + AMC2-4WE	60VA + 60VA	2 x 5VA + 2 x 5VA	50VA + 50VA	20VA + 20VA

Tab. 4.1: Overview - power supply and power consumption

Explanations for the table columns:

Output power Power provided by the power supply.

Own usage Power used by AMC2 device

Available Power remaining for external devices

Constant load Amount of the available power that can be drawn constantly.

Hence **Example 1** can be read as follows:

Of the total incoming power (60VA) 5VA will be drawn by the AMC2 itself . This leaves 55VA to support external devices. 25VA of these 55VA can be used for constant load (e.g. a card reader) leaving 30VA for occasional peak usage (e.g. a door opener).

4.8 RS-485 for extension modules

The AMC2-4R4 is connected to the AMC2 controller using the RS-485 extension interface. This interface will also be used to connect further extension modules.



Figure 4.9: Location of the RS-485 extension module bus

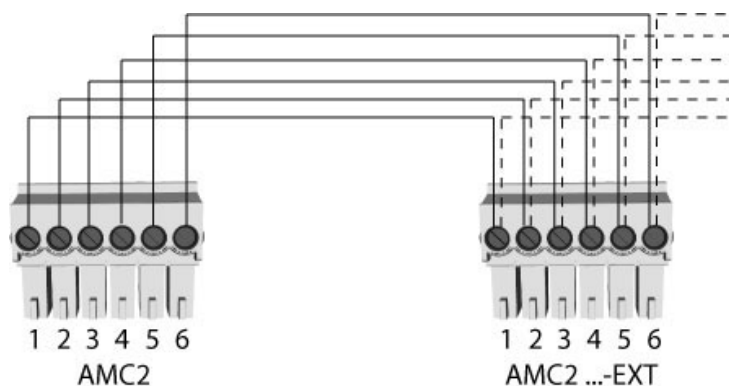

Figure 4.10: Connection of an extension module to an AMC2

4.9 Wiegand Interface for Card Readers



Notice!

If your reader requires a voltage other than 12V or is the power consumption more than 200 mA then it will require an external power supply.

The AMC2-4W provides four ports for connecting a maximum of 4 readers with Wiegand interfaces. Each interface is connected using a 10-pin pluggable screw - refer to *Connecting Diagrams, page 33* .

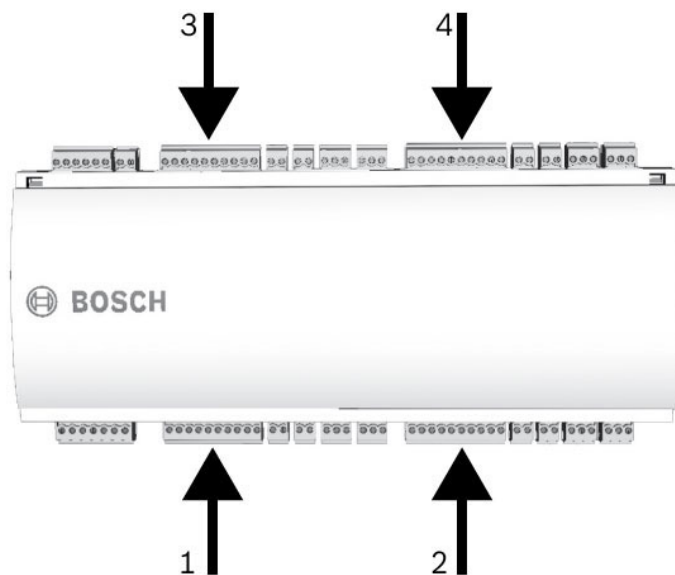

Figure 4.11: Location of the Wiegand interfaces for external devices

These interfaces are point-to-point connections, and each can support only a single reader with a maximum cable length of 90 m (300 ft) for 24 AWG or 150 m (500 ft) for 22 AWG. Readers are addressed according to their respective interface numbers. Refer to *Connecting Diagrams, page 33* for a complete wiring diagram of the Wiegand reader interface .

4.10 Connecting Relay Outputs

To operate locks or alarm systems, the AMC2-4W has eight relay outputs. The outputs will be connected to the 3-pin pluggable screw connectors S5, S6, S10, S11, S17, S18, S22, and S23 - refer to chapter *Connecting Diagrams, page 33*.

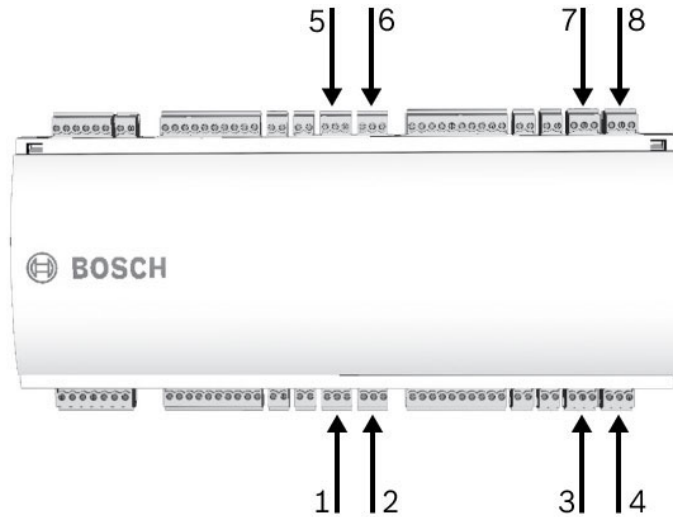

Figure 4.12: Location of the relay output connectors

Each relay output can operate in ‘wet’ mode, using the AMC2-4W’s internal 12/24 Vdc power supply for external devices or ‘dry’ mode with potential free contacts for externally powered systems.

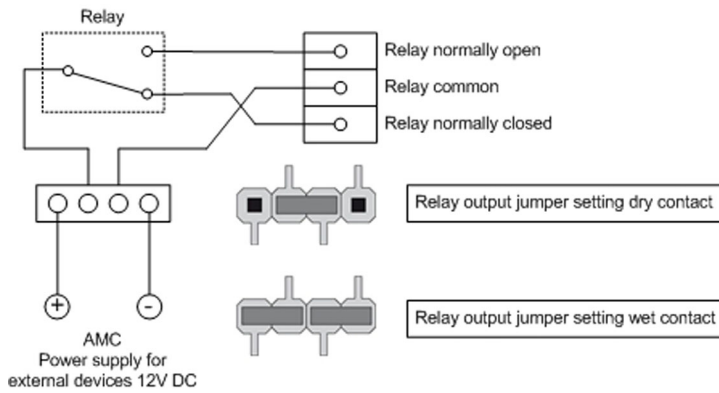

Figure 4.13: Wet mode and dry mode of the AMC2 relay outputs



Notice!
Risk of damage to equipment

To prevent damage to the relays note the following specifications.

- the maximum switching current is 1.25 A
- the maximum switching voltage is 30 Vdc
- only ohm resistive load can be connected to the relay
- inductive loads have to be short circuited using recovery diodes, see image below. These diodes (1N4004) are supplied with every AMC2-4W package.
- If you need higher voltage for special applications you have to connect external relays to the outputs. Depending on the power supply mode, it is recommended to use the following Wiegand relay types:
 - Flare move 12DC1W10A
 - Flare move 24DC1W16A

If using locally manufactured products, please ensure that the specifications of the product are identical with the those listed above.

A complete connection diagram of the relay output connectors is shown in *Connecting Diagrams, page 33*.

wet mode:

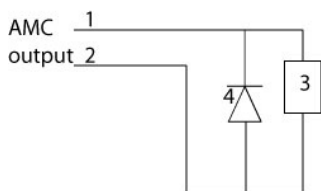

dry mode:

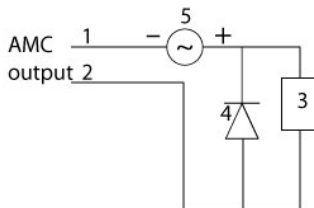

Figure 4.14: Recovery diode schematic

1	normally open/normally closed	1	normally open/normally closed
2	common	2	common
3	load	3	load
4	diode	4	diode
		5	voltage source



Notice!

Risk of damage to equipment

Do not connect externally powered devices in wet mode. This can damage the AMC2-4W .

Each relay output has a separate jumper setting on the underside of the circuit board to select dry (D1) or wet (D2) mode.

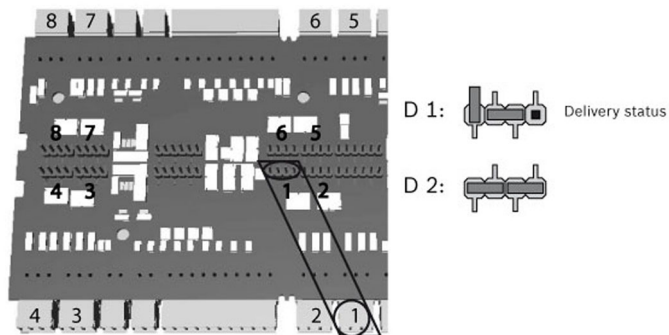

Figure 4.15: Location of relay output jumpers (bottom side)



Notice!

The positions of the jumpers 1 and 2 are interchanged related to the corresponding interfaces.

4.11 Connecting Analog Input Devices



Notice!

Risk of damage to equipment

Do not connect external power supply to the AMC2 inputs.

When connecting a relay output to an AMC2 input use dry mode with potential-free contact - refer to *Connecting Relay Outputs*, page 22.

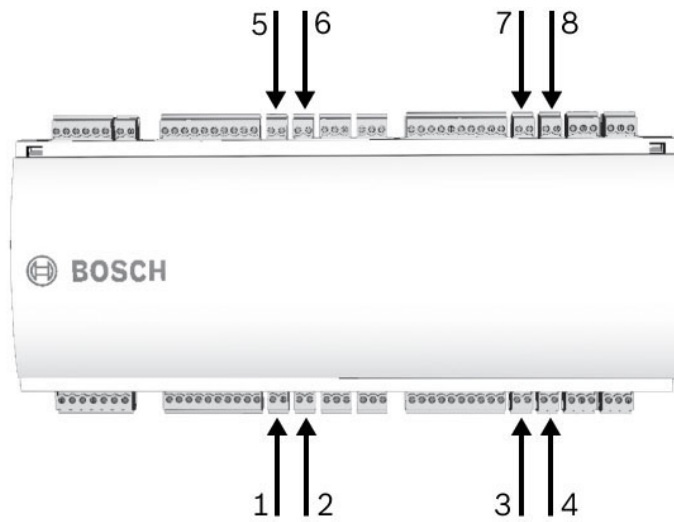

Figure 4.16: Location of the analog input connectors

To detect the four states, the voltage drop in the connecting cable may not exceed special values. The following table shows the maximum values of permissible cable resistance depending on the used resistor combination.

R_p	1k	1k2	1k5	1k8	2k2	2k7	3k3	3k9	4k7	5k6	6k8	8k2
R_s												
1k	220	220	220	210	200							
1k2	260	270	270	270	260	240						
1k5	310	330	340	350	350	340	310	280				
1k8	340	380	390	410	410	410	400	370	330	290	200	
2k2		430	460	490	510	520	510	500	460	420	340	240
2k7		490	540	570	620	630	640	640	620	580	510	420
3k3			610	650	700	740	770	780	770	750	700	620
3k9				720	790	850	890	910	910	910	880	810
4k7					880	960	960	970	1100	1100	1050	1050
5k6						1050	1100	1200	1200	1300	1300	1250
6k8							1300	1400	1500	1500	1500	1500

R_p	1k	1k2	1k5	1k8	2k2	2k7	3k3	3k9	4k7	5k6	6k8	8k2
R_s												
8k2								1500	1650	1700	1800	1900

Table 4.2: Maximum values of cable resistance per used resistor combination in Ohm

4.12 Tamper Protection

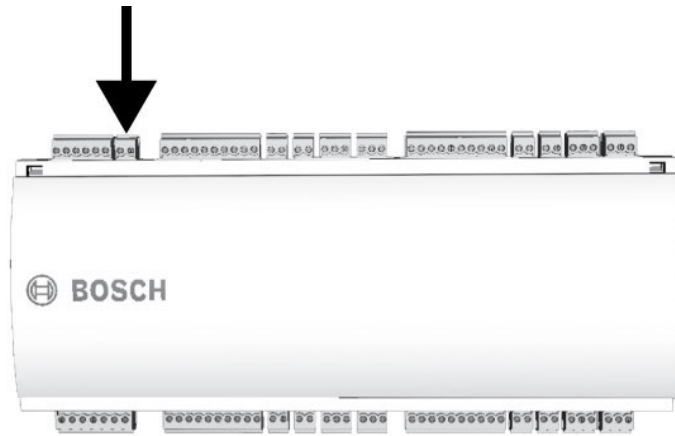

Figure 4.17: Location of the tamper protection contact

5

Operating

5.1

Status Display of the AMC2

Because the AMC2-4R4 has no display of its own, the AMC2 controller displays status information about the input and output settings of the AMC2.

The selected display mode remains set until the next time the button is pressed. The order of the display pages is shown in the following table.

Push	Display (Example)	Description
0	V01.00 02.03.07 or LBUS or BG900	Software versions and date of the firmware - every 5 sec. alternating with the display of the reader interface.
1a	S/N1: 0910019212	BOSCH serial number
1b	S/N2: 00000001	
2	02.06 15:35:15 (S)	Current date and time (S) = Summer; (W) = Winter
3	Dig. IO: ::::::::::::::	Display of the digital contacts: the input signals set will be shown with an extension above - output signals with an extension below.
3a	Dig. I1: ::::::::::::::	If there are I/O-Boards connected the signals will be shown on separate pages.
3b	Dig. I2: ::::::::::::::	
3c	Dig. I3: ::::::::::::::	
4	MAC 0010174C8A0C	Network device address (MAC)
5	N AMC-1234-5678	Network name of the AMC2
6	I 192.168.10.18	IP-address of the AMC2
7	G 192.168.10.255	IP-address of the gateway (Version V 00.44 or higher)
8	M 255.255.255.0	Subnetmask (Version V 00.44 or higher)
9	H 192.168.10.10	IP-address of the host computer
10	DHCP 1	DHCP-status: 1 = on 0 = off
11	D 192.168.10.1	IP-address of the DNS server
12	Host: + "C"	Host activity: + = online - = offline "C" = Counter of the received data packages from the host interface. RS 485 Bus connection: A = Address 1 ... H = Address 8

6 Technical Data

- Four Wiegand interfaces for up to four card readers (Output rating: 280 mA)
- Eight relay outputs
 - maximum ratings (wet and dry):
switching voltage: 30 Vdc
switching current: 1,25 A
 - operating ratings (wet and dry):
1,25 A @ 30 Vdc
2 A @ 12 Vdc
1,5 A @ 24 Vdc
- Eight analog inputs with tamper detection; only connect dry contacts
- RS-485 extension interface:
Transfer rate: 9,6 kBit/s,
no parity, 8 bit, 2 stop bit
- Tamper contact for external enclosures

Power supply

10 to 30 Vdc
or via the AMC2-4W

Power consumption

AMC: 5 VA
Peripheral devices: using the PSU-60

- up to 55 VA
- constant load: 25 VA

Connectors

Pluggable screw connectors

Protection class

IP30

Environment temperature

13° C to 35° C (55° F to 95° F)

Humidity

Up to 95%, without condensation

Housing material

ABS with OC (UL 94 V-0)

Dimensions

(W/H/D) 232 x 90 x 63mm (8.9 x 3.5 x 2.5 in)

Weight

approx. 0.53kg (1.2lb)

7 Appendices

7.1 Connecting Diagrams

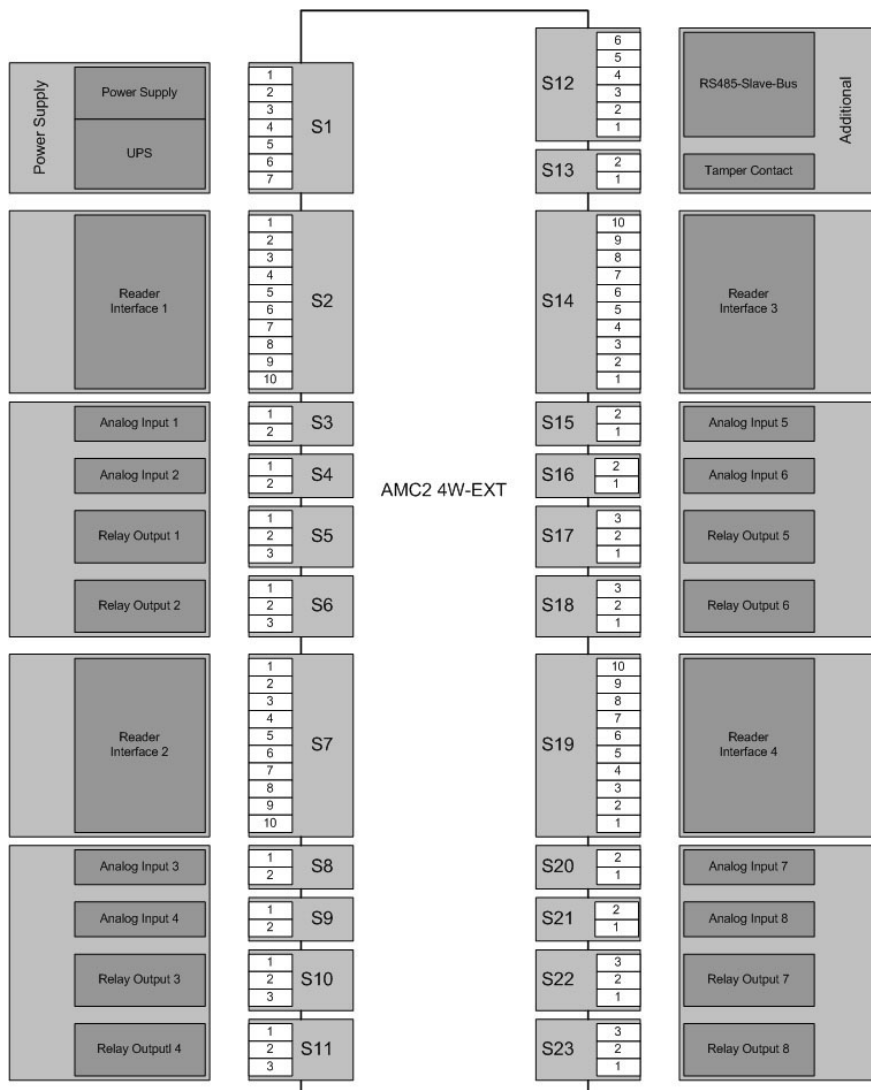

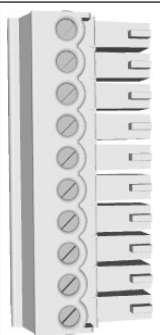

Figure 7.1: Connector blocks of the AMC2-4WE

	1	Power supply, DC positive (10V - 30V)
	2	Shield
	3	Power supply (0V)
	4	UPS (power good signal) - AC
	5	UPS (power good signal) - Battery
	6	UPS (power good signal) - DC
	7	UPS (power good signal) - Common

Tab. 7.3: Power supply

	1	red	Reader Supply (12V)
	2	black	Reader Supply (0V)
	3	green	Data 0
	4	white	Data 1
	5	drain	Shield
	6	orange	green LED
	7	brown	red LED
	8	yellow	Beeper
	9	blue	Hold
	10	violet	Card Present

Tab. 7.4: Wiegand interface AMC



Notice!

For reader settings refer to the respective reader manual.

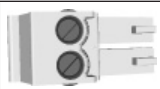
	1	Analog Input, in
	2	Analog Input, out

Tab. 7.5: Analog input

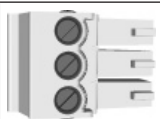
	1	Relay Output, normally open
	2	Relay Output, common
	3	Relay Output, normally closed

Tab. 7.6: Relay output

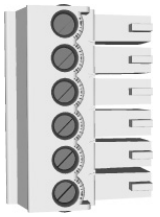
	1	Power supply for external devices (10V - 30V)
	2	Power supply for external devices (0V)
	3	Shield
	4	Data RxTx+
	5	Data RxTx-
	6	Ground (PAG)

Tab. 7.7: Host / Extension interface

	1	Tamper Contact, in
	2	Tamper Contact, out

Tab. 7.8: External tamper contact

Index

C

cabling 15

E

extension interface 31

I

inputs 9, 10

interfaces

 extension 31

 reader 10, 22, 31

M

mounting 12

O

opening 14

outputs 9, 10, 22, 31

P

power supply 15, 18

R

reader interfaces 10, 22, 31

 Wiegand 22

U

unmounting 13



Bosch Sicherheitssysteme GmbH

Robert-Bosch-Ring 5

85630 Grasbrunn

Germany

www.boschsecurity.com

© Bosch Sicherheitssysteme GmbH, 2018