







# 1X-X3 Installation Manual

<b>Copyright</b>	© 2013 UTC Fire & Security. All rights reserved.
<b>Trademarks and patents</b>	The 1X-X3 name and logo are trademarks of UTC Fire & Security. Other trade names used in this document may be trademarks or registered trademarks of the manufacturers or vendors of the respective products.
<b>Manufacturer</b>	UTC CCS Manufacturing Polska Sp. Z o.o. Ul. Kolejowa 24. 39-100 Ropczyce, Poland  Authorized EU manufacturing representative: UTC Fire & Security B.V. Kelvinstraat 7, 6003 DH Weert, Netherlands
<b>Version</b>	This document applies to 1X-X3 control panels with software version 1.0 or later.
<b>Certification</b>	
<b>European Union directives</b>	2004/108/EC (EMC directive).
 	2002/96/EC (WEEE directive): Products marked with this symbol cannot be disposed of as unsorted municipal waste in the European Union. For proper recycling, return this product to your local supplier upon the purchase of equivalent new equipment, or dispose of it at designated collection points. For more information see: <a href="http://www.recyclethis.info">www.recyclethis.info</a> .
	2006/66/EC (battery directive): This product contains a battery that cannot be disposed of as unsorted municipal waste in the European Union. See the product documentation for specific battery information. The battery is marked with this symbol, which may include lettering to indicate cadmium (Cd), lead (Pb), or mercury (Hg). For proper recycling, return the battery to your supplier or to a designated collection point. For more information see: <a href="http://www.recyclethis.info">www.recyclethis.info</a> .
<b>Contact information</b>	For contact information, see <a href="http://www.utcfireandsecurity.com">www.utcfireandsecurity.com</a> .

# Content

	Important information	ii
<b>Chapter 1</b>	<b>Introduction</b>	<b>1</b>
	Product description	2
	Product compatibility	2
<b>Chapter 2</b>	<b>Installation</b>	<b>3</b>
	Control panel cabinet layout	4
	Cabinet installation	5
	Connections	7
<b>Chapter 3</b>	<b>Configuration and commissioning</b>	<b>21</b>
	The user interface	23
	User levels	24
	Configuration overview	25
	Basic configuration	28
	Advanced configuration	34
	Expansion board configuration	49
	Commissioning	51
<b>Chapter 4</b>	<b>Maintenance</b>	<b>55</b>
	System maintenance	56
	Battery maintenance	57
<b>Chapter 5</b>	<b>Technical specifications</b>	<b>59</b>
	Zone specifications	60
	Input and output specifications	61
	Power supply specifications	63
	Mechanical and environmental specifications	64
<b>Appendix A</b>	<b>Configuration presets</b>	<b>67</b>
	Input and output configuration	68
	Default delays	68
	Basic configuration modes	68
	Expansion board functions	69
<b>Appendix B</b>	<b>Regulatory information</b>	<b>73</b>
	European standards	74
	<b>Index</b>	<b>77</b>

# Important information

This is the installation manual for the 1X-X3 Extinguishing and Fire Alarm Control Panel. Read these instructions and all related documentation entirely before operating this product.

## Software compatibility

Information in this document applies to control panels with software version 1.0 or later. This document must not be used as a guide to installation, configuration, or operation of control panels with an earlier software version. For instructions on how to check the software version of your control panel, see “Configuration, software, and PCB identification” on page 48.

## Advisory messages

Advisory messages alert you to conditions or practices that can cause unwanted results. The advisory messages used in this document are shown and described below.

---

**WARNING:** Warning messages advise you of hazards that could result in injury or loss of life. They tell you which actions to take or to avoid in order to prevent the injury or loss of life.

---

---

**Caution:** Caution messages advise you of possible equipment damage. They tell you which actions to take or to avoid in order to prevent the damage.

---

**Note:** Note messages advise you of the possible loss of time or effort. They describe how to avoid the loss. Notes are also used to point out important information that you should read.

## Limitation of liability

To the maximum extent permitted by applicable law, in no event will UTCFS be liable for any lost profits or business opportunities, loss of use, business interruption, loss of data, or any other indirect, special, incidental, or consequential damages under any theory of liability, whether based in contract, tort, negligence, product liability, or otherwise. Because some jurisdictions do not allow the exclusion or limitation of liability for consequential or incidental damages the preceding limitation may not apply to you. In any event the total liability of UTCFS shall not exceed the purchase price of the product. The foregoing limitation will apply to the maximum extent permitted by applicable law, regardless of whether UTCFS has been advised of the possibility of such damages and regardless of whether any remedy fails of its essential purpose.

Installation in accordance with this manual, applicable codes, and the instructions of the authority having jurisdiction is mandatory.

While every precaution has been taken during the preparation of this manual to ensure the accuracy of its contents, UTCFS assumes no responsibility for errors or omissions.



# Chapter 1

# Introduction

## **Summary**

This chapter provides an introduction to your control panel and the available operating modes

## **Content**

Product description 2  
Product compatibility 2

## Product description

The 1X-X3 control panel provides three fire detection zones (Z1, Z2, and Z3) and several manual call point (MCP) and control inputs that control the extinguishing actions for a single extinguishing area.

If a fire detection zone is not configured as part of the extinguishing detection area, the control panel provides standard fire panel functionality for that fire detection zone. For example, the panel activates fire sounders, fire routing, and other auxiliary outputs.

Consult your system installer for configuration details about the fire zones that have been assigned to the fire extinguishing area or (optionally) to fire detection zones.

## Product compatibility

Products compatible with this control panel are listed in the supplied compatibility list. Compatibility with products that are not listed in that document cannot be guaranteed.

For further details contact your local supplier.



# Chapter 2

# Installation

## Summary

This chapter explains how to install your control panel, how to connect zones, fire and extinguishing system devices, and the power supply.

**Note:** This product must be installed and maintained by qualified personnel adhering to the CEN/TS 54-14 standard (or the corresponding national standard) and any other applicable regulations.

## Content

Control panel cabinet layout	4
Cabinet installation	5
Preparing the cabinet	5
Where to install the cabinet	5
Fixing the cabinet to the wall	5
Connections	7
Recommended cables	7
Connecting zones with initiating devices	7
Connecting inputs	10
Connecting outputs	14
Connecting the mains power supply	16
Connecting the batteries	18
Connecting other equipment	18

# Control panel cabinet layout

Figure 1: Control panel cabinet layout

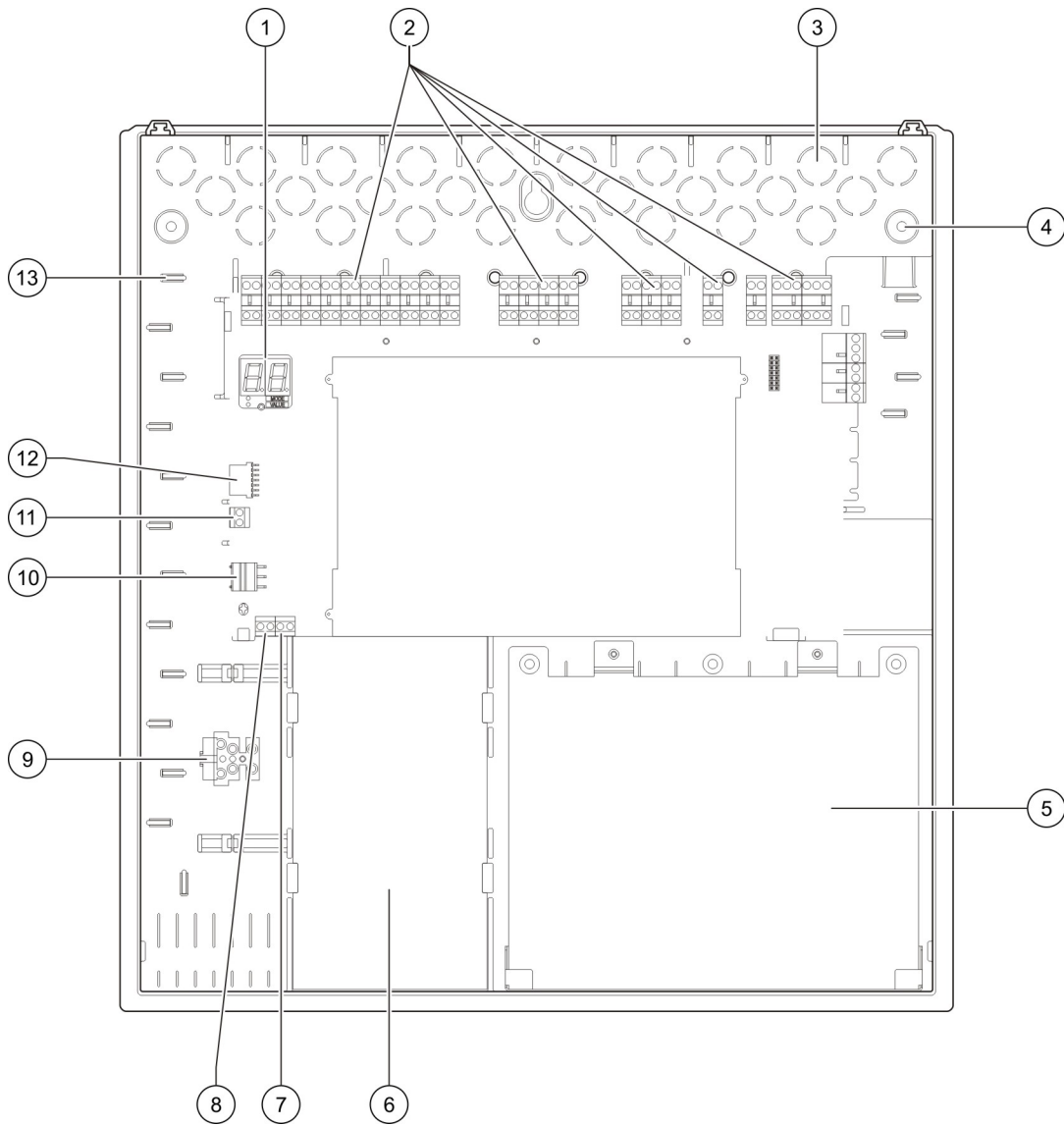

- |  |  |
|--|--|
| 1. Seven-segment display                     | 8. MCP release connector (reserved for future use) |
| 2. Zone, input, output, and relay connectors | 9. Fuse terminal block                             |
| 3. Cable knockouts                           | 10. Power supply connector                         |
| 4. Mounting screw knockouts                  | 11. Battery connector                              |
| 5. Battery area                              | 12. Expansion board connector                      |
| 6. Power supply unit                         | 13. Cable holder                                   |
| 7. Key connector (see note)                  |  |

**Note:** The control panel is available with an access key option. The key switch is located on the panel cover. With this option, either the key or the password can be used to enter the operator user level.

# Cabinet installation

## Preparing the cabinet

Before installing the cabinet, remove the front cover, and then remove cable knockouts from the top, bottom, and rear of the cabinet as required.

## Where to install the cabinet

Make sure the installation location is free from construction dust and debris, and immune to extreme temperature ranges and humidity. (See “Mechanical and environmental specifications” on page 64 for more information on the operating temperature and relative humidity specifications.)

Allow for enough floor and wall space so the panel can be installed and serviced without any obstructions. The cabinet should be mounted so that the user interface is at eye level.

Note that the control panel must be assembled and installed according to the ordinances and codes that are in effect in your market or region.

## Fixing the cabinet to the wall

Fix the cabinet to the wall using five M4 × 30 screws and five 6 mm diameter wall plugs, as shown below.

**Figure 2: Mounting hole locations**

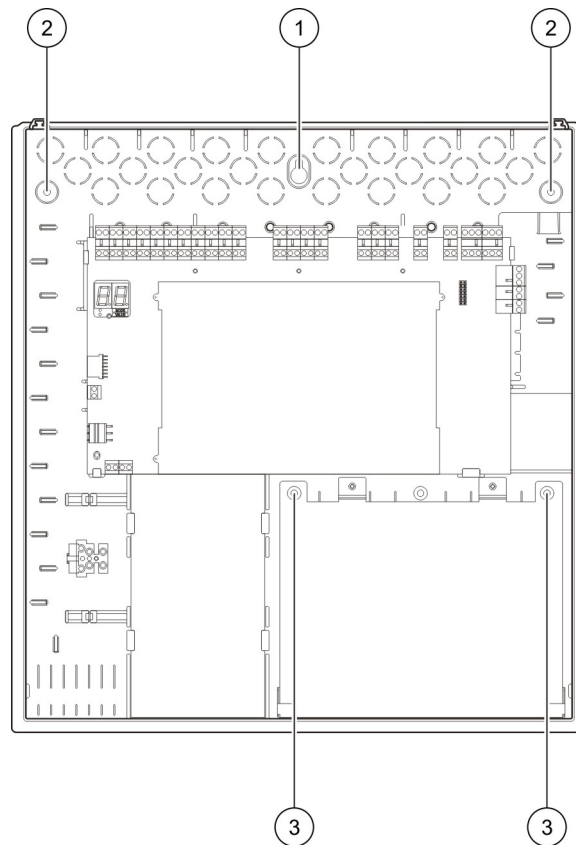

**To fix the control panel cabinet to the wall:**

1. Mark drill points on the wall, using the cabinet as a template.
2. Drill all required holes and insert a 6 mm wall plug into each.
3. Insert a screw in position (1) and hang the cabinet onto this screw.
4. Insert screws in positions (2) and tighten.
5. Insert screws in position (3) and tighten.
6. Tighten screw in position (1).

# Connections

**WARNING:** Electrocutation hazard. To avoid personal injury or death from electrocution, do not make any control panel or system connections while the control panel is connected to the mains power supply.

## Recommended cables

Recommended cables for optimal system performance are shown in the table below.

**Table 1: Recommended cables**

Cable	Cable description	Maximum cable length
Mains cable	3 x 1.5 mm <sup>2</sup>	N/A
Zone cable (mixed zone)	12 to 26 AWG (0.13 to 3.31 mm <sup>2</sup> ) Twisted-pair (max. 40 Ω / 500 nF)	2 km
Zone cable (automatic or manual zones)	12 to 26 AWG (0.13 to 3.31 mm <sup>2</sup> ) Twisted-pair (max. 55 Ω / 500 nF)	2 km

**Note:** Other types of cable may be used subject to site-specific EMI conditions and installation testing.

Use 20 mm cable glands to ensure clean and secure connections at the control panel cabinet. All cables should be fed through the cable guides in the cabinet housing to eliminate movement.

## Connecting zones with initiating devices

### Zone configuration

The control panel has three fire detection zone inputs, marked Z1, Z2, and Z3 on the control panel PCB to define the extinguishing area.

By default, Z1 and Z2 cover the extinguishing area and are configured for automatic detection of an extinguishing event. (Both zones must be in fire alarm condition to determine an extinguishing event.) The default configuration for Z3 provides standard fire detection as a mixed zone (using automatic or manual fire alarm detection).

Refer to “Extinguishing zones” on page 39 for instructions on changing the extinguishing area configuration. The following options are available.

**Option 1 — Z1.** An alarm in Z1 initiates the extinguishing event. The control panel provides standard fire detection for Z2 and Z3, both as mixed zones.

**Option 2 — Z1 and Z2.** This is the default configuration). Both Z1 and Z2 must be in alarm to initiate an extinguishing event. Z3 provides standard fire detection as a mixed zone.

**Option 3 — Z1, Z2, and Z3.** All three zones cover the extinguishing area. An alarm in any two of the zones initiates an extinguishing event. None of the zones provides standard fire detection functionality.

**Connecting zones**

Figure 3 below shows connections for the default configuration (option 2).

**Figure 3: Connecting zones for the default configuration**

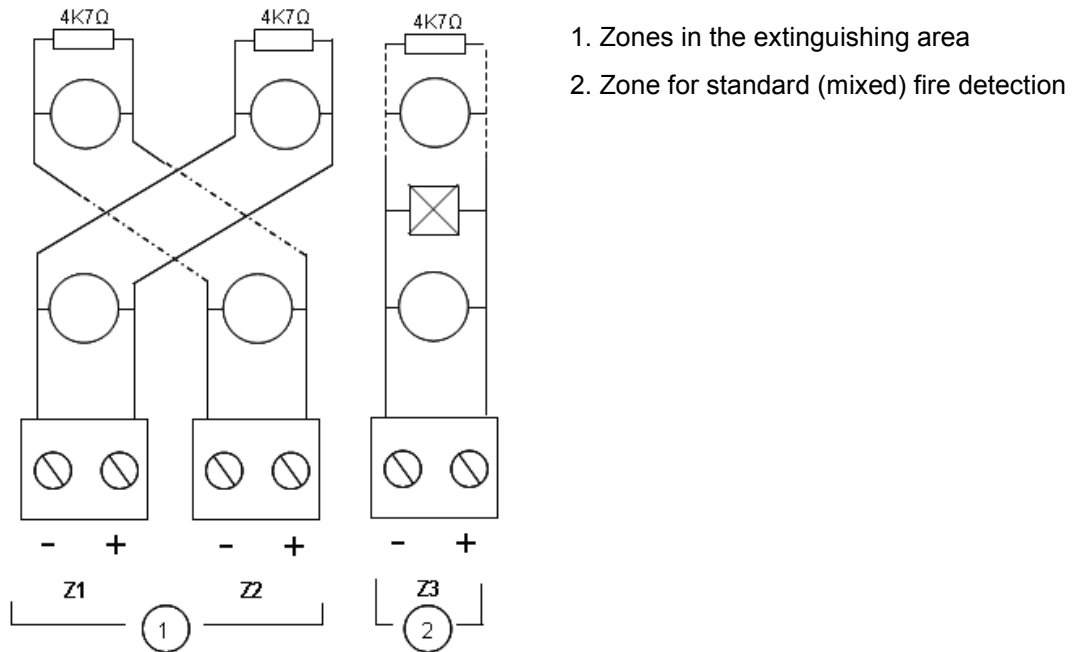

**Line resistance**

Line resistance is shown in the following table.

**Table 2: Zone line resistance values**

Zone type	Resistance
Mixed detection	40 Ω max.
Automatic detection	55 Ω max.
Manual detection	55 Ω max.

**To measure the line resistance:**

1. Disconnect all zone devices.
2. Create a short circuit at the end of the zone line.
3. Measure the resistance between the positive and negative lines with a multimeter.

## Terminating zones

Zone termination is required at all times, whether the zone is used or not. The type of termination depends on the installation, as shown below.

**Table 3: Zone termination**

Installation type	Termination
EN 54-2	4.7 k $\Omega$ , 5%, 1/4 W end-of-line resistor
BS 5839-1	Active end-of-line device (see note below)

**Note:** For BS 5839-1 installations an active end-of-line device must be installed (instead of an end-of-line resistor). Unused zones must be terminated with an active end-of-line device or configured as passive end-of-line and terminated with a 4.7 k $\Omega$ , 5%, 1/4 W end-of-line resistor.

The type of zone termination can be configured on a zone-by-zone basis. See “Zone configuration” on page 45. Advanced installer user level access is required.

## Connecting fire detectors

Connect detectors as shown in Figure 3 on page 8.

The panel supports conventional detectors. To guarantee optimal operation, use the detectors specified in the compatibility list. For more information on fire detectors, see Chapter 5 “Technical specifications” on page 59.

## Connecting fire alarm manual call points

Connect fire alarm manual call points in parallel. Each fire zone can support a maximum of 32 manual call points.

In zones used for fire detection, manual call points must have a resistance installed in series with the normally open (NO) contact for activation. This avoids reporting a short circuit fault and allows identification of the alarm type (automatic or manual) based on the impedance.

In zones used for the extinguishing area, alarms are always reported as automatic (detector). A series impedance is also required to avoid reporting a short circuit fault.

The resistance required depends on the zone type, as shown in the table below.

**Table 4: Fire alarm manual call point resistance values**

Zone type	Resistance [1]
Mixed detection	100 $\Omega$
Manual detection	100 to 680 $\Omega$

[1] Resistance must be rated at 1 W minimum.

## Connecting inputs

### Input functionality

Each control panel has eight inputs, marked IN1 to IN8 on the control panel PCB. Input functionality is shown in the table below.

**Table 5: Input functionality**

Input	Function	Supervision
IN1	Start extinguishing manual call point	Supervised
IN2	Hold extinguishing manual call point	Supervised
IN3	Abort extinguishing manual call point	Supervised
IN4	Manual-only mode activation device	Unsupervised
IN5	Low pressure indication	Supervised
IN6	Extinguishing agent flow	Supervised
IN7	Safety door fault monitoring	Supervised
IN8	Remote reset	Unsupervised

### Input termination

Only supervised inputs require a 15 kΩ, 5%, 1/4 W end-of-line resistor for termination. If a supervised input is not used, the end-of-line resistor must be installed across the unused terminals.

### Connecting inputs

Connect inputs IN1 to IN8 as shown below.

**Figure 4: Connecting inputs**

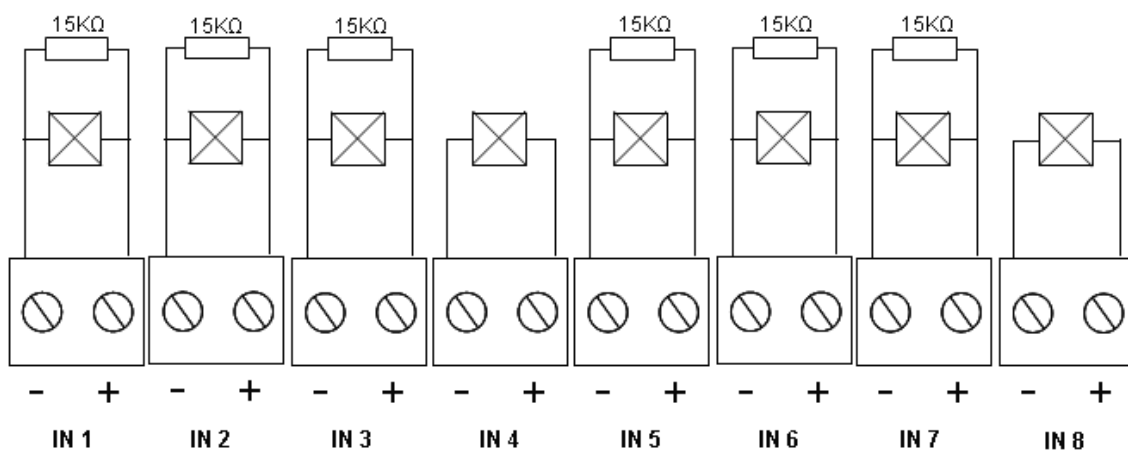

Refer to the topic “Input and output specifications” on page 61 for the input circuit parameters.



## Connecting extinguishing system manual call points

The manual call point inputs require an activation impedance between 100 and 620  $\Omega$ , 2 W. These are normally connected in series with a normally open (NO) contact. An end-of-line resistance of 15 k $\Omega$  is required.

When the abort extinguishing or hold extinguishing manual call points are activated, the control panel activates the related relay outputs on the main board.

**Note:** MCP Hold faults and MCP Abort faults prevent the panel from entering the extinguishing activation state (because of life safety issues) and from activating the actuator (to ensure property protection).

The extinguishing system supports three types of manual call point (MCP):

- MCP Start
- MCP Hold
- MCP Abort

Descriptions of each MCP type follow.

**MCP Start.** Starts the extinguishing process. When the panel is in the standby, extinguishing preactivation, or fire alarm state, activation of this device puts the panel in the extinguishing activation state.

The control panel can be configured to bypass any actuator delay and to activate the actuator immediately on entering the extinguishing activation state. To configure this, set the “Actuator delay for Start MCP” to OF.

**MCP Hold.** Holds the extinguishing process. When the panel is in the extinguishing activation state, the actuator output is not activated while the MCP Hold device is activated (continuously). The MCP Hold input can be configured for two different operating modes.

Mode A: When the MCP Hold is activated, the actuator delay countdown continues, but the panel is prevented from entering the extinguishing activation state. When the MCP Hold is deactivated, the delay countdown determines when the panel enters the extinguishing activation state.

In Mode A, activation of the MCP Hold turns on the MCP Hold LED, which stays on until the panel is manually reset. The yellow Preactivation LED flashes to indicate that the panel is being prevented from entering the extinguishing activation state. The Preactivation LED flashes to show when the MCP Hold is on; it turns off when the MCP Hold is off.

Mode B: When the MCP Hold is activated, the actuator delay countdown stops, putting the extinguishing release process on hold. The sounders emit a unique sound pattern (1 second on, 4 seconds off) while the extinguishing release process is on hold. When the MCP Hold is deactivated, the delay countdown restarts and the sounder pattern changes to the tone configured for extinguishing activation. The MCP Hold LED turns off when the MCP Hold device is deactivated.

See “Hold mode” on page 38 for instructions on setting the MCP Hold operating mode.

**MCP Abort.** Aborts the extinguishing process. During the standby, extinguishing preactivation, extinguishing activation, and fire alarm states, activating the MCP Abort device prevents the extinguishing process until the MCP Abort device is deactivated and the control panel is reset.

### **Connecting an external device for manual-only mode control**

When the control panel is in manual-only mode, the extinguishing process can only be initiated manually, using the MCP Start device. Automatic extinguishing events reported by the fire detection zones are disabled for extinguishing activation.

This mode of operation can be used when the user interface is not suitable for your application and a remote control is needed.

A manual-only mode input device is used to switch the panel to this mode. In addition to connecting a manual-only mode activation device, you must configure the system by setting the “Manual-only mode local” option to OF.

EU ordinances and regulations require the use of a key switch to control access to this function.

Refer to the topic “Input and output specifications” on page 61 for the required impedance values for this unsupervised input.

### **Connecting a low pressure indication switch**

Use the low pressure indication input to detect low pressure in the extinguishing agent container.

The “Pressure switch type” option defines whether the device detects low pressure when open or when closed. In the device standby state, either normally open or normally closed, the input is not interpreted as a low pressure fault. The default setting is normally closed (NC). This results in a low pressure fault when the switch opens.

The topic “Input and output specifications” on page 61 shows how the low pressure indication device impedance is related to the low pressure fault.

### **Connecting an extinguishing agent flow device**

Use the extinguishing agent flow input to connect a device that detects the release of the extinguishing agent from its container into the extinguishing area.

**Note:** Before you connect a device to the extinguishing agent flow input, make sure that it is compatible with the required input impedance levels of the control panel, as specified in the topic “Input and output specifications” on page 61.

The “Extinguishing agent flow” option lets you define the functionality of this device. Here are the details.

When the extinguishing agent flow option is set to OF, the panel enters the extinguishing released state when the actuator output is activated. The panel does not require confirmation of the flow to enter this state. The extinguishing agent flow circuitry continues to operate for indication purposes. The panel will

not enter the release state when the extinguishing agent flow device is active without first entering the extinguishing activation state (i.e. when an extinguishing event is detected).

When the extinguishing agent flow option is set to ON, the control panel can enter the extinguishing released state from any state, once the extinguishing agent flow device is activated. In extinguishing released state, the panel activates all corresponding outputs, *except for the actuator output*.

At the same time, even though a fire alarm was not detected, the panel enters the fire alarm state so that the fire alarm can be reported via the fire relay.

### **Connecting a safety door fault monitoring device**

The safety door fault monitoring input lets the panel monitor a door in the extinguishing area. The monitored door becomes a *safety door*.

A safety door fault means that the door is in a position that will prevent the release process, given the current operating mode of the panel. A safety door fault prevents the panel from entering the extinguishing activation state (because of life safety issues) and activating the actuator (to ensure property protection).

When the panel is in manual-only mode, the safety door must be open. A closed door signal is interpreted as a fault.

When the panel is in manual-automatic mode, the safety door must be closed. An open door signal is interpreted as a fault.

You can configure a delay before the panel interprets a safety door monitor signal as a fault. This allows for momentary opening or closing of the door for routine traffic. The delay is bypassed when the panel enters the extinguishing activation or extinguishing released states.

By default, the control panel is configured for basic applications which do not use this monitoring function. If your installation requires it, activate the function by setting the “Safety door monitoring” option to ON, and specifying a “Safety door fault delay” between 10 and 90 seconds.

Here are the operating details of the function.

When the panel is not in extinguishing activation or extinguishing released states:

- For manual-automatic mode, the panel reports a fault if the door is open and the door fault delay expires
- For manual-only mode, the panel reports a fault if the door is closed and the door fault delay expires

When the system is in extinguishing activation or extinguishing released states, no matter which operating mode, the panel reports a fault if the door is open.

### **Connecting a remote reset device**

The remote reset input allows the control panel to be reset from a remote location. The reset operation is the same as using the Reset button on the control panel user interface.

EU ordinances and regulations require the use of a key switch to control access to this function.

The remote reset is executed when the input device switches from deactivated to activated. Refer to the topic “Input and output specifications” on page 61 for the impedance values for this unsupervised input.

## Connecting outputs

### Output functionality

Each control panel has eight outputs, marked OUT1 to OUT8 on the control panel PCB. Output functionality is shown in Table 6 below.

**Table 6: Output functionality**

Output	Function	Type and status
OUT1	Hold extinguishing manual call point	Free-of-voltage (unsupervised switch) Hold inactive = open Hold active = closed
OUT2	Abort extinguishing manual call point	Free-of-voltage (unsupervised switch) Abort inactive = open Abort active = closed
OUT3	Manual-only mode	Free-of-voltage (unsupervised switch) Manual-automatic = open Manual-only = closed
OUT4	Extinguishing released	Free-of-voltage (unsupervised switch) Released inactive = open Released = closed
OUT5	Fire sounders	Supervised (standard) Off = -11 VDC (supervision) On = +24 VDC
OUT6	Extinguishing sounders	Supervised (standard) Off = -11 VDC (supervision) On = +24 VDC
OUT7	Extinguishing released optical warning panels or signs	Supervised (standard) Off = -11 VDC (supervision) On = +24 VDC
OUT8	Extinguishing actuator	Supervised (extinguishing EOL) Off = -11 VDC (supervision) On = +24 VDC

### Connecting free-of-voltage outputs

These outputs use the normally open (NO) and the common (C) terminals of a relay to provide the free-of-voltage, isolated, unsupervised switch functionality.

When the output is in standby the NO and C terminals are open. When the output activates, the relay changes to close the NO and C terminals.

The maximum rating per active output is 2 A at 30 VDC.

**Figure 5: Control panel free-of-voltage outputs**

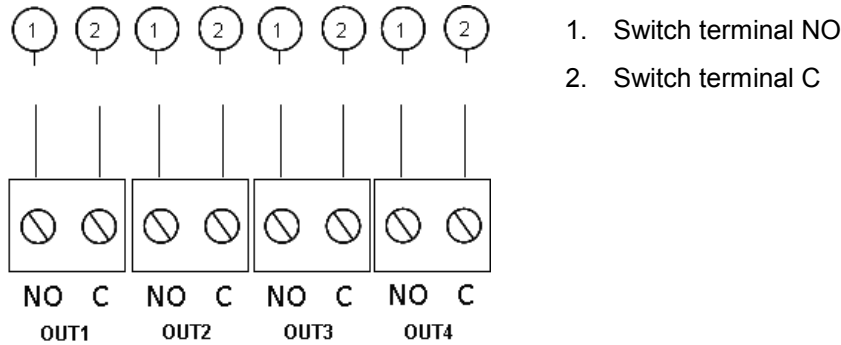

### Connecting standard supervised outputs

All standard supervised outputs require a 15 k $\Omega$ , 5%, 1/4 W end-of-line resistor as termination for proper detection of wiring problems (open or short circuit). If an output is not used, the end-of-line resistor must be installed across the unused terminals.

**Figure 6: Control panel standard supervised outputs**

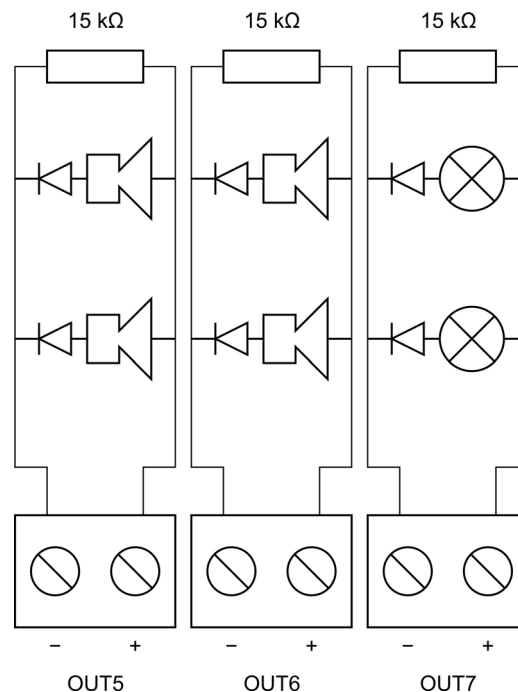

Standard supervised outputs provide -11 VDC in standby and +24 VDC when active (nominal values). Refer to the Outputs section of the Technical Specifications chapter for the details on the maximum current rating.

**Note:** Standard supervised outputs are polarity sensitive. Observe polarity or install a 1N4007 diode or equivalent to avoid inverted activation issues.

### Connecting the extinguishing actuator output

**Note:** Observe the polarity of the extinguishing actuator output to ensure proper operation.

---

**WARNING:** Risk of death or serious injury. Test the line supervision (for open and short circuit faults) and the activation function *before* connecting the extinguishing agent to the actuator.

---

The extinguishing actuator output is the most critical output of the system, as it controls the release of the extinguishing agent into the extinguishing area.

A special end-of-line circuit (the 2010-1EXT-EOL board) is required for proper operation so that the wiring to the extinguishing agent actuator is supervised.

**Note:** To ensure reliable operation, locate the end-of-line board as close as possible to the extinguishing actuator device.

**Figure 7: Control panel extinguishing actuator connection**

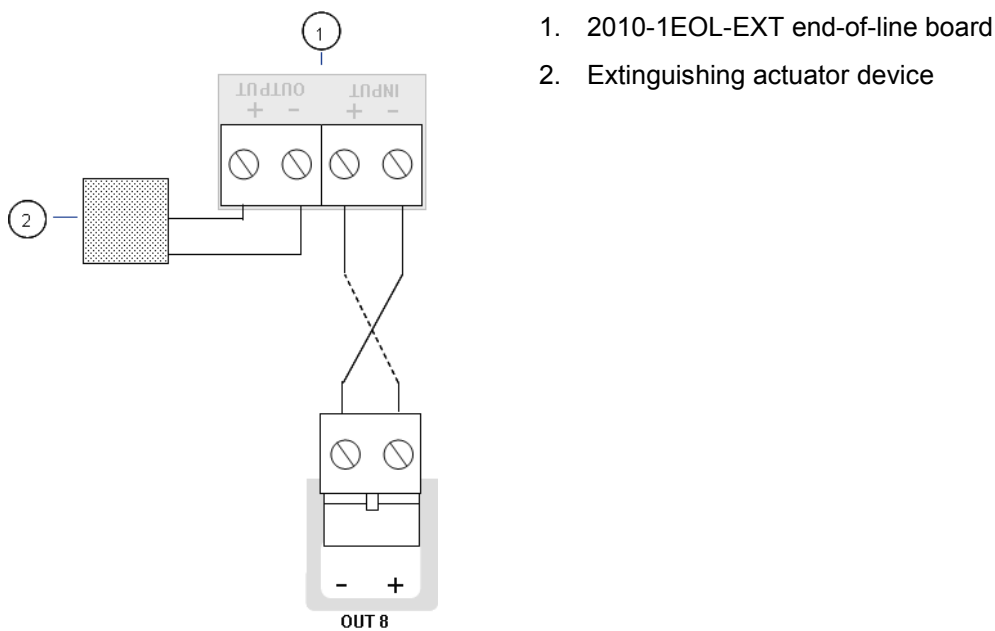

### Connecting the mains power supply

**Note:** To avoid unwanted arcing, connect the mains power supply before connecting the batteries.

The control panel can be operated at 110 VAC / 60 Hz or 240 VAC / 50 Hz (+10% or -15%).

Mains power should be sourced directly from a separate circuit breaker in the building electrical supply distribution board. This circuit should be clearly marked, have a bipolar disconnect device, and only be used for fire detection equipment.

Feed all mains cables through the appropriate cable knockouts and connect them to the fuse terminal block as shown in Figure 8 below.

Keep mains cables separate from other cabling to avoid potential short circuits and interference. Always secure mains cables to the cabinet to prevent movement.

**Figure 8: Connecting the mains power supply**

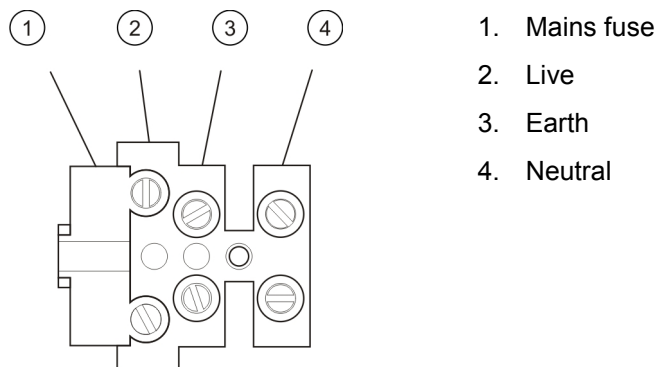

For fuse specifications, see “Power supply specifications” on page 63.

### Selecting 115 or 230 VAC operation

**WARNING:** Electrocutation hazard. To avoid personal injury or death from electrocution, remove all sources of power and allow stored energy to discharge before installing or removing equipment.

The default power setting is 230 VAC. For 115 VAC operation change the power setting switch, located on the side of the power supply unit, as shown in Figure 9 below.

**Caution:** Risk of equipment damage. An incorrect power setting can destroy the power supply.

**Figure 9: Selecting 115 or 230 VAC operation**

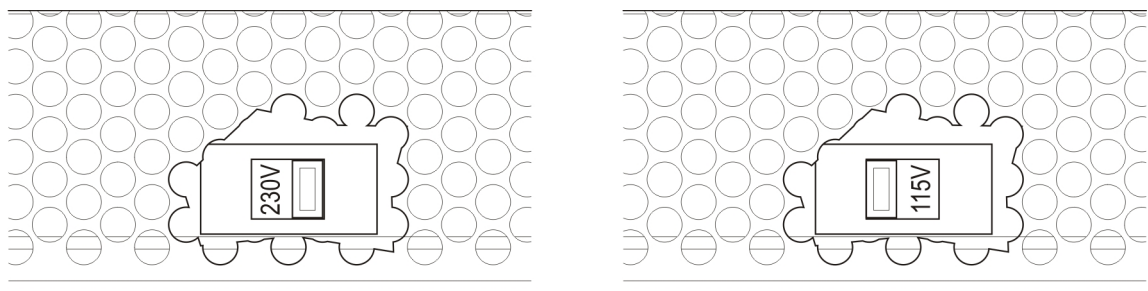

## Connecting the batteries

The control panel requires two 12 V, 7.2 or 12 Ah rechargeable, sealed, lead-acid batteries.

Batteries must be installed in series, at the base of the control panel cabinet. Use the battery lead and bridge provided and connect batteries to the BATT connector on the control panel PCB, as shown below. Polarity must be observed.

**Note:** If the control panel indicates a Supply Fault, then the batteries may need to be replaced. See “Battery maintenance” on page 57.

**Figure 10: Connecting the batteries**

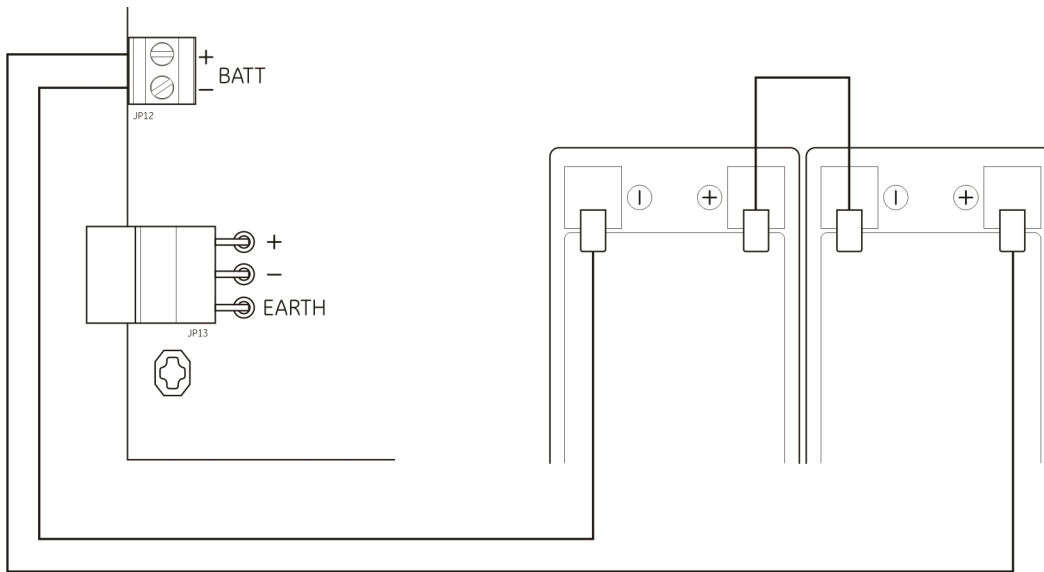

**Caution:** Risk of equipment damage. No other equipment may be connected to the BATT connector.

## Connecting other equipment

### Connecting auxiliary equipment

Connect auxiliary equipment to the 24VAUX output as shown in Figure 11 on page 19. The 24 VDC auxiliary output is supervised for short circuit and voltage output.

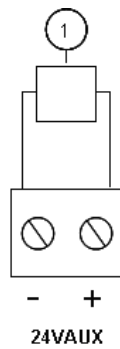

**Figure 11: Auxiliary power supply output connection (24VAUX)**

1. External equipment to be powered with 24 VDC

Refer to Table 22 on page 63 for the maximum current and other output ratings.

**Caution:** Never use the auxiliary output to power expansion boards connected to the same control panel as this might damage the control panel hardware.

### Connecting alarm and fault relays

Connect alarm and fault equipment to the ALARM and FAULT relays.

Each potential-free relay output is activated in the corresponding alarm or fault situation. The fault relay output is activated when there is no fault. This means that there is a short circuit between the common (C) and normally open (NO) terminals of the relay.

The maximum contact rating for each relay circuit is 2 A at 30 VDC.

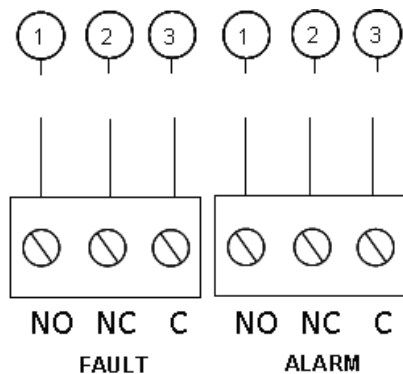
**Figure 12: Fault and alarm relay output connections**

1. Normally open contact
2. Normally closed contact
3. Common



# Chapter 3

## Configuration and commissioning

### Summary

This chapter includes information on how to configure and commission the control panel. Configuration is divided in basic configuration and advanced configuration options.

### Content

The user interface	23
User levels	24
Configuration overview	25
Configuration controls	25
Common configuration tasks	27
Basic configuration	28
The basic configuration menu	28
Basic default configuration	29
Panel mode	30
Actuator delay	31
Reset disabled delay	31
Fire sounders delay	32
Fire routing delay	32
Fire delay operation	33
Adding expansion boards	33
Advanced configuration	34
The advanced configuration menu	34
Safety door monitoring	36
Safety door fault delay	37
Pressure switch type	37
Hold mode	38
Activation tone	38
Released tone	39
Extinguishing zones	39
Manual-only mode local	40

- Actuator delay for start MCP 41
- Extinguishing agent flow 42
- Fire sounder operation during a zone test 43
- Fire sounder re-sound 43
- Fire Sounders silence disabled time 44
- Zone configuration 45
- Zone delay 45
- Zone type 46
- Changing user level passwords 47
- Auxiliary 24 V reset 48
- Configuration, software, and PCB identification 48
- Expansion board configuration 49
  - Adding an expansion board 49
  - Expansion board configuration 49
- Commissioning 51
  - Before commissioning the control panel 51
  - Commissioning the control panel 52
  - Functional tests 53
  - Response times 54

# The user interface

Figure 13: The user interface

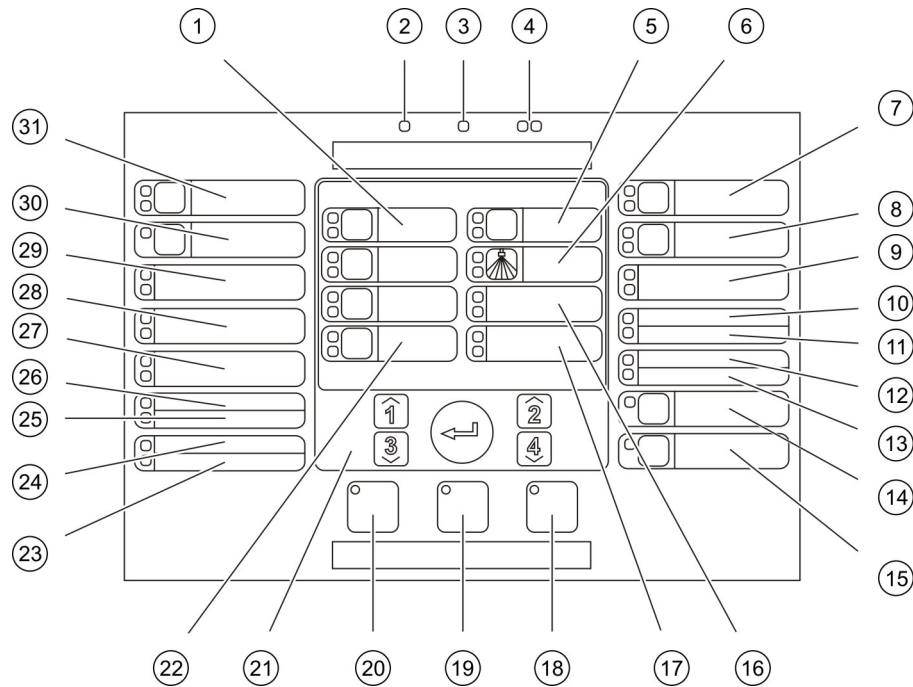

- |  |   |
|--|---|
| 1. Zone buttons and LEDs (Z1, Z2, Z3)        | 16. Low Pressure LEDs                       |
| 2. Supply LED                                | 17. Extinguishing Agent Flow LEDs           |
| 3. General Fault LED                         | 18. Reset button and LED                    |
| 4. General Fire Alarm LEDs                   | 19. Panel Silence button and LED            |
| 5. Preactivation button and LEDs             | 20. Fire Sounders Start/Stop button and LED |
| 6. Released LEDs                             | 21. Numeric keypad and Enter button         |
| 7. Extinguishing Sounders On button and LEDs | 22. Manual Mode button and LED              |
| 8. Fire Sounders Delay button and LEDs       | 23. System Fault LED                        |
| 9. Optical Panel On LEDs                     | 24. Out of Service LED                      |
| 10. Door Fault/Disabled LED                  | 25. Earth Fault LED                         |
| 11. Networking Fault LED                     | 26. Supply Fault LED                        |
| 12. Service Detector LED                     | 27. MCP Abort LEDs                          |
| 13. Expansion I/O Fault/Disabled LED         | 28. MCP Hold LEDs                           |
| 14. General Disable button and LED           | 29. MCP Start LEDs                          |
| 15. General Test button and LED              | 30. Fire Routing Delay button and LED [1]   |
|  | 31. Fire Routing On button and LEDs [1]     |

[1] Fire routing is only available if a 2010-1-SB board is installed and a fire routing command is configured.

## User levels

For your safety, access to some features of this product are restricted by user levels. The access privileges of each user level are described below.

The configuration tasks described in this chapter can only be performed by an installer user level, either basic or advanced. These user levels are reserved for the installation contractors authorized and responsible for the system installation and configuration.

### Public user

The public user level is the default user level.

This level allows basic operating tasks, such as responding to fire alarms, extinguishing events, or fault warnings at the control panel. No password is required.

### Operator user

The operator user level allows additional operating tasks that command the system or perform maintenance functions. It is reserved for authorized users who have been trained to operate the control panel.

Consult the operation manual for more details on the functions available for public user and operator user levels.

### Basic installer user

The basic installer user level allows the quick configuration of basic installation options that cover most applications.

### Advanced installer user





The advanced installer user level allows the detailed configuration of very specific applications where the advanced features provided by the control panel are required. This level is also required for installers that require minor customizations after configuring a basic installation.

Passwords and indications for each user level are described in “User level passwords and indications” below.

### User level passwords and indications

The default user level passwords and the corresponding LED and seven-segment display indications are shown in Table 7 on page 25. The seven-segment display is only visible when the control panel cover is removed. Figure 1 on page 4 shows the location of the seven-segment LED (item 1).

**Table 7: User level passwords and indications**

User level	Password	LED	Default display	Custom display
Public	None	None	None	None
Operator	2222	The Reset LED is steady	None	None
Basic installer	3333	The Reset LED is flashing fast		
Advanced installer	4444	The Reset LED is flashing fast		

**Note:** If you have used advanced configuration options to set a custom zone delay, zone configuration, or zone type, then the seven-segment display defaults to the custom display operating mode. See “Panel mode” on page 30 for details.

## Configuration overview

To facilitate rapid configuration of the most common tasks, configuration is divided into basic and advanced levels.

For basic configuration options, see “Basic configuration” on page 28. For advanced configuration options see “Advanced configuration” on page 34.

**Note:** The Reset and Panel Silence functions are not available when you are in configuration mode. To reset the control panel or silence the internal buzzer, first exit from configuration mode. See “Common configuration tasks” on page 27 for instructions on exiting from configuration mode.

## Configuration controls

The control panel is configured using the front panel configuration controls and the seven-segment display.

### The configuration controls

The configuration controls are located on the control panel interface.

**Figure 14: Front panel configuration controls**

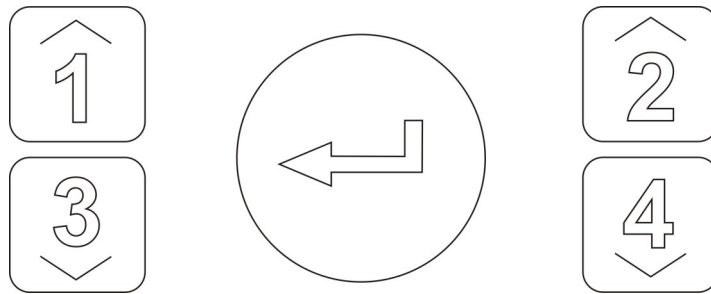

Button	Function
1	Scroll to the next configuration menu on the seven-segment display.
2	Scroll to the next configuration value for the active menu on the seven-segment display.
3	Scroll to the previous configuration menu on the seven-segment display.
4	Scroll to the previous configuration value for the active menu on the seven-segment display.
Enter	Confirm a menu selection or a value selection entry.

**Note:** The configuration controls are also used to enter the user level password.

### The seven-segment display

The seven-segment display is only visible when the control panel cover is removed (see Figure 1 on page 4).

**Figure 15: The seven-segment display**

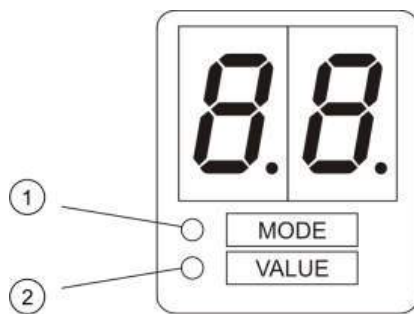

1. Mode LED
2. Value LED

**Table 8: Mode and value LEDs**

LED	Indications
Mode	Select a configuration menu using buttons 1 and 3 when this LED is steady, or Select a configuration submenu using buttons 1 and 3 when this LED is flashing.
Value	Select a configuration value using buttons 2 and 4 when this LED is steady



## Common configuration tasks

### To enter configuration mode:

1. Remove the control panel cover so that the seven-segment display is visible.
2. Enter a valid installer user level password (3333 for basic configuration or 4444 for advanced configuration).
3. Press Enter.

When first entering configuration mode, the Mode LED on the seven-segment display is steady. For other indications, see Table 8 on page 26.

### To select a menu:

1. Select the required menu using the menu selection buttons (1 and 3).
2. Press Enter.

When a configuration menu has been selected, the Value LED on the seven-segment display is steady.

### To select a value:

1. Select the required value using the value selection buttons (2 and 4).
2. Press Enter.

### To exit configuration mode and save your changes:

1. Press Panel Silence.
2. Press Enter.

— or —

1. Set the display as shown below, and then press Enter.



The Panel Silence LED flashes to confirm that a configuration change has been applied.

**Note:** Make all required configuration changes before exiting configuration mode and saving your changes.

### To exit configuration mode without saving your changes:

1. Press Reset

— or —

1. Set the display as shown below, and then press Enter.

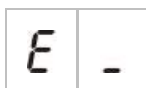

The control panel will exit configuration mode after 5 minutes if no button is pressed.

### Visible indications for current value and selected value

Current and selected values are indicated as follows.

**Table 9: Visible indications for values**

Status	Indication
Current value	Both decimal points on the display are steady
New selected value	Both decimal points on the display are flashing
Other value	Both decimal points on the display are off

#### To restore the previous configuration:

1. Set the display as shown below, and then press Enter.



#### To restore the factory configuration:

1. Set the display as shown below, and then press Enter.



## Basic configuration

The default password for basic configuration is 3333. After entering the password, the first displayed menu will be Basic default configuration (indicating the basic installer user level). For more information see “User level passwords and indications” on page 24.

### The basic configuration menu

Configuration options for this menu are shown in the table below. More information for each option is included in the related topic.

**Table 10: The basic configuration menu**

Display	Menu	Values
b R	Basic default configuration	01, 02, 05, 06
n o	Panel mode	Basic standard Basic evacuation Custom
R d	Actuator delay	00 to 60 seconds
r d	Reset disabled delay	00 to 30 minutes
S d	Fire sounders delay	00 to 10 minutes
F d	Fire routing delay	00 to 10 minutes
n n	Add an expansion board	00 to 04 modules
r C	Restore previous configuration	N/A
F C	Restore factory configuration	N/A
E -	Exit without saving	N/A
E S	Exit and save	N/A

**Note:** Additional menu options are available if one or more expansion boards are installed. See “Expansion board configuration” on page 49.

## Basic default configuration

Use this menu to select operating mode configuration presets.

In both basic standard and basic evacuation modes, zone detection is the same. The extinguishing area uses Z1 and Z2 (automatic). Fire detection uses Z3 (mixed).

Available presets are shown in the table below. The default setting is 01 (Basic standard mode, passive end-of-line).

**Table 11: Operating mode configuration presets**

Display	Mode	Zone configuration	Manual fire sounder start	Actuator delay for MCP Start
01 (default)	Basic standard	Passive end-of-line	No	Yes
02	Basic standard	Passive end-of-line, CleanMe enabled	No	Yes
05	Basic evacuation	Passive end-of-line	Yes (operator user level) [1]	No (bypassed)
06	Basic evacuation	Passive end-of-line, CleanMe enabled	Yes (operator user level) [1]	No (bypassed)
00	Custom [2]	N/A	N/A	N/A

[1] A fire alarm is not required to activate the fire sounders.

[2] This option cannot be selected. It is displayed automatically when an advanced configuration is entered

**To change the operation mode configuration preset:**

1. Set the display as shown below, and then press Enter.



2. Select a value using the value selection buttons (2 and 4).
3. Press Enter.
4. Save your changes.

**Panel mode**

Use this read-only menu to view the operating mode of the control panel.

**To view the panel mode:**

1. Set the display as shown below, and then press Enter.

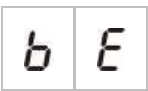
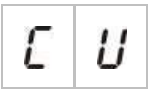

Display indications for each operating mode are shown below.

Display	Panel mode	Description
	Basic standard	Fire sounders cannot be manually activated (fire sounders are only activated if there is a fire alarm).
	Basic evacuation	Fire sounders can be manually activated at operator user level (a fire alarm is not required).
	Custom	A custom operating mode is configured. The display alternates between CU (custom) and the operation mode (basic standard or basic evacuation).

**Note:** In basic evacuation operating mode, the configured actuator delay is bypassed when MCP Start is activated. The actuator output is activated immediately.

### Custom panel operating mode

A custom panel operating mode will be indicated if any of the following zone configuration settings are changed from the operating mode preset values:

- Zone delay
- Zone configuration
- Zone type

## Actuator delay

When the control panel enters the extinguishing activation state, the actuator delay starts counting down. The extinguishing actuator output is activated when the delay time expires. (Activation of the MCP Hold or MCP Abort point prevents the panel from entering the extinguishing activation state.)

Use this menu to configure an actuator delay of up to 60 seconds (in steps of 5 seconds). The default setting is for a 10-second delay.

### To configure an actuator delay:

1. Set the display as shown below, and then press Enter.



The red Release LED flashes fast to indicate that the delay configuration menu is active.

2. Select a delay value from 00 to 60 seconds using the value selection buttons (2 and 4).
3. Press Enter.
4. Save your changes.

## Reset disabled delay

When the control panel enters extinguishing activation, the reset disabled delay starts counting down, and the reset is disabled until the delay expires.

Use this menu to configure a reset disabled delay of up to 30 minutes (in steps of 1 minute). The default setting is for a 2-minute delay.

### To configure a reset disabled delay:

1. Set the display as shown below, and then press Enter.

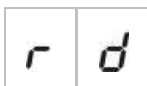

The Reset LED flashes fast to indicate that the delay configuration menu is active.

2. Select a delay value from 00 to 30 minutes using the value selection buttons (2 and 4).
3. Press Enter.
4. Save your changes.

## Fire sounders delay

Use this menu to configure a fire sounders delay of up to 10 minutes. The default setting is 00 (no delay). For more information on delay operation, see “Fire delay operation” on page 33.

### To configure a fire sounders delay:

1. Set the display as shown below, and then press Enter.



The Fire Sounders Delay LED flashes fast to indicate that the sounder delay configuration menu is active.

2. Select a delay value from 00 to 10 minutes using the value selection buttons (2 and 4).
3. Press Enter.
4. Save your changes.

Once configured the delay must be enabled at the operator user level.

### To enable a configured delay:

1. Exit the installer user level.
2. Enter the operator user level password.
3. Press the Sounder Delay button.

A steady Sounder Delay LED indicates that the delay is enabled.

## Fire routing delay

Use this menu to configure a fire routing delay of up to 10 minutes. The default setting is 00 (no delay). For more information on delay operation, see “Fire delay operation” on page 33.

### To configure a delay:

1. Set the display as shown below, and then press Enter.



The Fire Routing Delay LED flashes fast to indicate that the fire routing delay configuration menu is active.

2. Select a delay value from 00 to 10 minutes using the value selection buttons (2 and 4).
3. Press Enter.
4. Save your changes.

Once configured the delay must be enabled at the operator user level.

**To enable a configured delay:**

1. Exit the installer user level.
2. Enter the operator user level password.
3. Press the Fire Routing Delay button.

A steady Fire Routing Delay LED indicates that the delay is enabled.

## Fire delay operation

Delays can be configured for fire sounders and for fire routing. These delays will only be applied when all of the following are true:

- The configured delay has been enabled
- The initiating device is a detector or a manual call point installed in an automatic zone or the initiating device is a detector installed in a mixed zone
- The initiating device is in a zone configured for delays (the default configuration)

If any of the above points are not true, then the control panel activates the fire sounders and fire routing immediately after the detection of the fire alarm.

Sounder delays are bypassed when the alarm is detected in an extinguishing zone.

## Adding expansion boards

To add an expansion board to the system you must install the board and then configure the system. Refer to the board's installation guide for installation instructions. Refer to the topic "Expansion board configuration" on page 49 for configuration instructions.









## Advanced configuration

The default password for advanced configuration is 4444. After entering the password, the first displayed menu is the Advanced default configuration (indicating advanced installer user level). For more information see “User level passwords and indications” on page 24.

### The advanced configuration menu



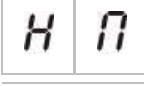
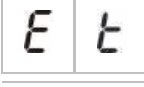
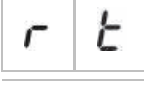
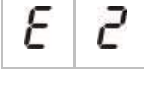



Configuration options for this menu are shown in the table below. More information for each option is included in the related topic.

**Table 12: The advanced configuration menu**

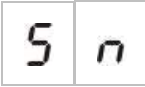
Display	Menu	Values
	Advanced default configuration	See Table 11 on page 30
	Panel mode	Basic standard Basic evacuation Custom
	Actuator delay	00 to 60 seconds
	Reset disabled delay	00 to 30 minutes
	Safety door monitoring	ON/OFF
	Safety door fault delay	10 to 90 seconds
	Pressure switch type	Normally closed Normally open
	Hold mode	Mode A Mode B
	Activation tone	Pulsed Continuous
	Released tone	Pulsed Continuous
	Extinguishing zones	Z1 extinguishing, Z2 and Z3 fire Z1 and Z2 extinguishing, Z3 fire Z1, Z2, and Z3 extinguishing
	Manual-only mode local	ON/OFF

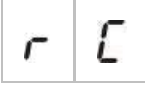

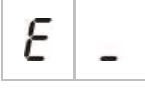
Display	Menu	Values
d 5	Actuator delay for start MCP	ON/OFF
g f	Extinguishing agent flow	ON/OFF
s d	Fire sounders delay	00 to 10 minutes
s b	Sounders operation during a zone test	ON/OFF
s r	Sounders re-sound	ON/OFF
s t	Silence sounders disabled time	00 to 10 minutes
f d	Fire routing delay	00 to 10 minutes
n n	Module number	00 to 04 See "Expansion board functions" on page 69.
s o	Software version	Read-only
c f	Configuration version	Read-only
c h	Configuration time stamp	Read-only
c d	Configuration date stamp	Read-only
z o	Zone configuration	Passive EOL Active EOL Passive EOL with CleanMe Active EOL with CleanMe
z d	Zone delay	ON/OFF
z n	Zone type	Mixed Automatic Manual
L 2	Operator user level password	0 to 4444
L b	Basic installer user level password	0 to 4444

Display	Menu	Values
	Advanced installer user level password	0 to 4444
	Control panel PCB serial number	Read-only
	Auxiliary 24V reset	ON/OFF
	Restore previous configuration	N/A
	Restore factory configuration	N/A
	Exit without saving	N/A
	Exit and save	N/A

**Note:** Refer to the topic “Basic configuration” on page 28 for details on the settings available in basic configuration: Panel mode, Actuator delay, Reset disabled delay, Fire sounders delay, and Fire routing delay.

## Safety door monitoring

Use this menu to configure safety door monitoring, on or off. The default setting is OFF.

For a description of the safety door monitoring function, see “Connecting a safety door fault monitoring device” on page 13.

### To configure safety door monitoring:



1. Set the display as shown below, and then press Enter.



The Door Fault LED flashes fast to indicate that the configuration menu is active.

2. Select a value using the value selection buttons (2 and 4).
3. Press Enter.
4. Save your changes.

The available settings for this feature are shown below.

Display	Description
	Safety door monitoring is used (on).
	Safety door monitoring is not used (off).

## Safety door fault delay

Use this menu to configure a delay from 10 to 90 seconds (in steps of 5 seconds) in reporting safety door faults caused by incorrect status (open or closed). The default setting is 30 seconds.

### To configure a safety door delay:

1. Set the display as shown below, and then press Enter.



The Door Fault/Disabled LED flashes fast to indicate that the delay configuration menu is active.

2. Select a delay value from 10 to 90 seconds using the value selection buttons (2 and 4).
3. Press Enter.
4. Save your changes.

## Pressure switch type

Use this menu to configure the low pressure switch for detection of the container pressure. Correct pressure can be either normally closed (NC) or normally open (NO). The default setting is normally closed (NC).

### To configure the pressure switch type:

1. Set the display as shown below, and then press Enter.

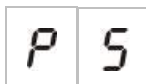

The Low Pressure LED flashes fast to indicate that the configuration menu is active.

2. Select a value using the value selection buttons (2 and 4).
3. Press Enter.
4. Save your changes.

The available settings for this feature are shown below.

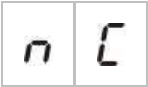
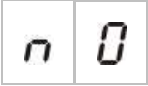
Display	Description
	Operates as normally closed (NC).
	Operates as normally open (NO).

## Hold mode

Use this menu to set the operating mode for this device (mode A or B). The default setting is mode A.

For a description of the emergency MCP Hold function and device, see “Connecting extinguishing system manual call points” on page 11.

### To configure the emergency hold device mode:

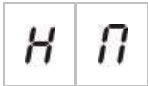

1. Set the display as shown below, and then press Enter.



The MCP Hold LED flashes fast to indicate that the configuration menu is active.

2. Select a value using the value selection buttons (2 and 4).
3. Press Enter.
4. Save your changes.

The available settings for this feature are shown below.

Display	Description
	Mode A: The actuator delay countdown continues during MCP Hold activation.
	Mode B: The actuator delay countdown restarts when the MCP Hold device is restored. MCP Hold is indicated using a specific sounder tone.

## Activation tone

Use this menu to set the extinguishing activation tone of the extinguishing sounders on the control panel PCB: continuous or pulsed. The pulsed pattern is 1 second on, 1 second off. The default setting is pulsed mode.

### To configure the activation tone:

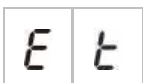

1. Set the display as shown below, and then press Enter.



The red Extinguishing Sounders LED flashes fast to indicate that the configuration menu is active.

2. Select a value using the value selection buttons (2 and 4).
3. Press Enter.
4. Save your changes.

The available settings for this feature are shown below.

Display	Description
	Pulsed mode
	Continuous mode

## Released tone

Use this menu to set the extinguishing released tone of the extinguishing sounders on the control panel PCB: continuous or pulsed. The pulsed pattern is 1 second on, 1 second off. The default setting is continuous mode.

### To configure the released tone:

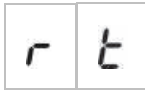

1. Set the display as shown below, and then press Enter.



The red Extinguishing Sounders LED flashes fast to indicate that the configuration menu is active.

2. Select a value using the value selection buttons (2 and 4).
3. Press Enter.
4. Save your changes.

The available settings for this feature are shown below.

Display	Description
	Pulsed mode
	Continuous mode

## Extinguishing zones

Use this menu option to define the extinguishing area required for your installation.

The control panel provides three fire detection zones that can be assigned for automatic detection of an extinguishing event. Fire detection zones that are not linked to the extinguishing area are assigned standard fire detection functionality. The configuration options available are shown below.

**Option 1 — Z1.** An alarm in Z1 initiates the extinguishing event. The control panel provides standard fire detection for Z2 and Z3, both as mixed zones.

**Option 2 — Z1 and Z2.** This is the default configuration). Both Z1 and Z2 must be in alarm to initiate an extinguishing event. Z3 provides standard fire detection as a mixed zone.

**Option 3 — Z1, Z2, and Z3.** All three zones cover the extinguishing area. An alarm in any two of the zones initiates an extinguishing event. None of the zones provides standard fire detection functionality.

For more information, see “Connecting zones with initiating devices” on page 7.

#### To configure the extinguishing zones:

1. Set the display as shown below, and then press Enter.



The Zone yellow LEDs flash quickly to indicate that the configuration menu is active.

2. Select a value using the value selection buttons (2 and 4).
3. Press Enter.
4. Save your changes.

The available settings for this feature are shown below.

Display	Description
	Z1 is configured as an extinguishing zone. Z2 and Z3 are configured as fire detection zones.
	Z1 and Z2 are configured as extinguishing zones. Z3 is configured as a fire detection zone.
	Z1, Z2, and Z3 are configured as extinguishing zones. No fire detection zones are provided.

## Manual-only mode local

When the control panel is in manual-only mode, the extinguishing process can only be initiated manually, using the MCP Start device. Automatic extinguishing events reported from the fire detection zones are disabled for extinguishing activation.

The panel can be switched to manual-only mode using two methods: the panel Manual Mode button (local), or a manual-only mode activation device (remote).

Use this option to configure which method is used to switch to manual-only mode. The default configuration is to use the panel button (i.e. to use local control), so manual-only mode local is ON.

For more information see “Connecting an external device for manual-only mode control” on page 12.

#### To configure the manual-only mode control:



1. Set the display as shown below, and then press Enter.



The yellow Manual Mode LED flashes fast to indicate that the configuration menu is active.

2. Select a value using the value selection buttons (2 and 4).
3. Press Enter.
4. Save your changes.

The available settings for this feature are shown below.

Display	Description
	Manual-only mode is set locally. Manual-only mode is activated by the Manual Mode button on the panel.
	Manual-only mode is set remotely. Manual-only mode is activated by the manual-only mode activation device.

## Actuator delay for start MCP

Use this menu to configure the control panel behaviour after a manual extinguishing event (from the MCP Start point): activate the actuator immediately or apply the actuator delay configured for automatic extinguishing events.

The default settings are:

- Basic standard mode = ON
- Basic evacuation mode = OF

#### To configure the actuator delay for start MCP:



1. Set the display as shown below, and then press Enter.



The red Start MCP LED flashes fast to indicate that the configuration menu is active.

2. Select a value using the value selection buttons (2 and 4).
3. Press Enter
4. Save your changes.

The available settings for this feature are shown below.

Display	Description
	Actuator delay applies to the MCP Start.
	MCP Start activates the actuator immediately (no delay).

## Extinguishing agent flow

Use this menu to configure how the control panel enters into the extinguishing released state: using extinguishing agent flow confirmation or immediately after the activation of the actuator.

The default setting does not use extinguishing agent flow confirmation: extinguishing agent flow OF. Note that with this configuration the control panel continues to provide indications of the extinguishing agent flow for information purposes (wiring faults and activation).

If your installation requires an extinguishing agent flow signal, see “Connecting an extinguishing agent flow device” on page 12 for more information.

### To configure extinguishing agent flow:



1. Set the display as shown below, and then press Enter.



The red Released LED flashes fast to indicate that the configuration menu is active.

2. Select a value using the value selection buttons (2 and 4).
3. Press Enter.
4. Save your changes.

The available settings for this feature are shown below.

Display	Description
	Extinguishing released after extinguishing agent flow input activation.
	Extinguishing released after actuator activation. (Extinguishing agent flow indications available for information purposes)



## Fire sounder operation during a zone test

Use this menu to configure the sounder operation during a zone test. The default setting for all operating modes is ON.

### To configure the sounder operation during a zone test:

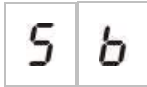

1. Set the display as shown below, and then press Enter.



The Fire Sounders Start/Stop LED flashes fast to indicate that the sounder operation during a zone test configuration menu is active.

2. Select a value using the value selection buttons (2 and 4).
3. Press Enter.
4. Save your changes.

The available settings for this feature are shown below.

Display	Description
	The internal buzzer and sounders sound for 5 seconds when an alarm is activated in a zone test.
	The internal buzzer and sounders do not sound when an alarm is activated in a zone test.

## Fire sounder re-sound

Use this menu to configure the sounder re-sound, on or off. This determines sounder operation in a fire alarm event when sounders have been silenced by pressing the Fire Sounder Start/Stop button and a new alarm event is reported in a different zone. The default setting is ON.

### To configure the sounder re-sound:

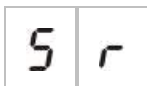

1. Set the display as shown below, and then press Enter.



The Sounders Start/Stop LED flashes fast to indicate that the sounder re-sound configuration menu is active.

2. Select a value using the value selection buttons (2 and 4).
3. Press Enter.
4. Save your change

The available settings for this feature are shown below.

Display	Description
	The sounders re-sound if a new fire alarm event is reported from a different zone.
	The sounders do not re-sound if a new fire alarm event is reported from a different zone.

## Fire Sounders silence disabled time

**Note:** For control panels in basic evacuation mode, any configured fire sounders silence disable times are ignored.

To prevent the immediate silencing of fire sounders when a fire alarm is first reported, the Fire Sounder Start/Stop button may be temporarily disabled for a preconfigured period of time when a configured fire sounder delay is counting down.

The disable time starts to count down when the control panel enters fire alarm status and the configured fire sounder delay starts.

During the configured disable time the Fire Sounder Start/Stop LED is off and the fire sounders cannot be silenced (before activation) by pressing the Fire Sounder Start/Stop button.

In the time between the end of the configured disable time and the end of the configured fire sounder delay (when the Fire Sounder Start/Stop LED is flashing), pressing the Fire Sounder Start/Stop button silences sounders (before activation).

A configured fire sounder delay may still be cancelled while the delay is running (and sounders activated) by pressing the Fire Sounder Delay button.

Use this menu to configure the time while fire sounders silence is disabled. The default setting is 1 minute.

### To configure the Fire Sounders Silence Disabled Time:

1. Set the display as shown below, and then press Enter.

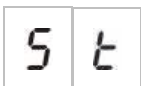

The Fire Sounders Start/Stop LED flashes fast to indicate that the Fire Sounders Silence Disabled Time configuration menu is active.

2. Select a delay value from 00 to 10 minutes using the value selection buttons (2 and 4).
3. Press Enter.
4. Save your changes.

## Zone configuration

Use this menu to configure zone settings for each zone in your fire alarm system.

### To configure the zone:

1. Set the display as shown below, and then press Enter.



2. Select the zone (for example, zone 1), and then press Enter.



The red Zone LED flashes fast to indicate that the corresponding zone configuration menu is active.

3. Select a value using the value selection buttons (2 and 4).
4. Press Enter.
5. Save your changes.

The available settings for this feature are shown below.

Display	Description
	Passive end-of-line
	Active end-of-line
	Passive end-of-line with CleanMe
	Active end-of-line with CleanMe

## Zone delay

Use this menu to configure zone delays, on or off, for each zone in your fire alarm system. The default setting is ON.

### To configure the zone delay:

1. Set the display as shown below, and then press Enter.





2. Select the zone (for example, zone 1), and then press Enter.



The Zone alarm LED flashes fast to indicate that the corresponding zone configuration menu is active.

3. Select a value using the value selection buttons (2 and 4).
4. Press Enter.
5. Save your changes.

The available settings for this feature are shown below.

Display	Description
	Configured delays are allowed in the corresponding zone.
	Configured delays are not allowed in the corresponding zone

## Zone type

Use this menu to configure the zone type for each zone in your system.

### To configure the zone type:

1. Set the display as shown below, and then press Enter.



2. Select the zone (for example, zone 1), and then press Enter.





The Zone Fault/Test/Disable LED flashes fast to indicate that the corresponding zone configuration menu is active.

3. Select a value using the value selection buttons (2 and 4).
4. Press Enter.
5. Save your changes.



The available settings for this feature are shown below.

Display	Description
	<p>Mixed zone. The control panel automatically distinguishes between an automatic alarm (generated by a detector) and a manual alarm (generated by a manual call point fitted with a 100 Ω resistor).</p> <p>This option is not available to zones configured in the extinguishing area.</p>

Display	Description
	<p>Automatic zone. All fire alarms are treated as reported by a detector, even if the fire alarm is reported by a manual call point in the zone.</p> <p>This is the option applied for zones configured in the extinguishing area.</p>
	<p>Manual zone. All fire alarms are treated as reported by a manual call point, even if the fire alarm is reported by a detector in the zone.</p> <p>This option is not available to zones configured in the extinguishing area.</p>

## Changing user level passwords

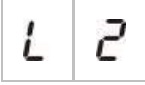
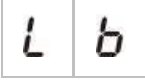
Use the corresponding menu option (shown below) to change the default user level passwords.

	Operator user level password
	Basic installer user level password
	Advanced installer user level password

### To change the first two digits of a user level password:

1. Set the display for the desired user level password, and then press Enter.
2. Set the display as shown below, and then press Enter.

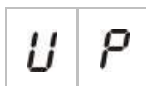

3. Select a value using the value selection buttons (2 and 4).
4. Press Enter.
5. Save your changes.

### To change the last two digits of a user level password:

1. Set the display for the desired user level password, and then press Enter.
2. Set the display as shown below, and then press Enter.



3. Select a value using the value selection buttons (2 and 4).
4. Press Enter.
5. Save your changes.

## Auxiliary 24 V reset

Use this menu to configure the auxiliary 24 V reset setting, on or off. The default setting is OF.

### To configure the 24 V reset:

1. Set the display as shown below, and then press Enter.



2. Select a value using the value selection buttons (2 and 4).
3. Press Enter.
4. Save your changes.

The available settings for this feature are shown below.

Display	Description
	Resetting the control panel resets the AUX 24V output.
	Resetting the control panel does not reset the AUX 24V output.

## Configuration, software, and PCB identification

Use the menu options shown below to see the control panel software version, configuration version, configuration date and time stamps, and the PCB serial number. For expansion boards, you can also see the software version and PCB serial number.

These details may be required for troubleshooting and technical support.

	Software version
	Configuration version
	Configuration time stamp
	Configuration date stamp
	Control panel PCB serial number

The “software version” and “control panel PCB serial number” menus display a submenu that lets you select the object of interest.

F	P	Fire panel
n	A	Module A
n	b	Module B
n	c	Module C
n	d	Module D

## Expansion board configuration

### Adding an expansion board

Use this menu, available from the basic or advanced configuration menus, to configure the number of installed expansion boards. The default value is 00.

#### To add an expansion board:

1. Set the display as shown below, and then press Enter.



The Expansion I/O Fault/Disabled LED flashes fast to indicate that the module configuration menu is active.

2. Select a value using the value selection buttons (2 and 4).  
Up to four expansion boards can be installed and configured.
3. Press Enter.
4. Save your changes.

## Expansion board configuration

### Expansion board labels

For configuration purposes expansion boards are labeled A, B, C, and D.

The label for a given module is defined by its position (left to right) in the control panel cabinet. The first expansion board installed is module A, the second B, etc.

See your expansion board installation sheet for installation instructions.

## Expansion board function and delay configuration

Once an expansion board is installed and added to the control panel configuration, the following additional configuration options appear on the basic and advanced configuration menus.

**Note:** These configuration options are repeated for each of the installed expansion boards (A, B, C, and D).

**Table 13: Expansion board A configuration options**

Display	Description	Value
	Module A function	01 to 96
	Module A output 1 delay	00 to 10 minutes
	Module A output 2 delay	00 to 10 minutes
	Module A output 3 delay	00 to 10 minutes
	Module A output 4 delay	00 to 10 minutes

### Expansion board function

Use this menu to configure the expansion board function. The default value is 41. For available presets, see the topic “Expansion board functions” on page 69.

#### To configure the expansion board function:

1. Set the display as shown below, and then press Enter.

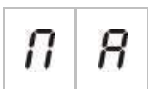

The Expansion I/O Fault/Disabled LED on the control panel interface and the ON LED on the expansion board flashes fast to indicate that the module function configuration menu is active.

2. Select a value from 01 to 96 using the value selection buttons (2 and 4).
3. Press Enter.
4. Save your changes.

### Expansion board output delay

Use this menu to configure an expansion board output delay of up to 10 minutes, where the feature is available.



**To configure an expansion board output delay:**

1. For output 1 on expansion board A, set the display as shown below, and then press Enter.



The Expansion I/O Fault/Disabled LED on the panel and the Activated LED on the expansion board flash fast to indicate that the delay menu is active.

2. Select a value from 00 to 10 minutes using the value selection buttons (2 and 4).
3. Press Enter.
4. Repeat steps 1 to 3 as required for each output (1 to 4) on each installed module (A, B, C, and D) where a delay is required.
5. Save your changes.

## Commissioning

### Before commissioning the control panel

Before commissioning the control panel, make sure that:

- The control panel has been correctly installed.
- The mains power is 110 VAC or 240 VAC, is connected correctly, and complies with all requirements described in “Connecting the mains power supply” on page 16.
- There are no short or open circuits in any of the zones.
- All zones have the correct end-of-line termination, as described in “Terminating zones” on page 9.
- All extinguishing devices (with special attention to the extinguishing actuator) are properly installed as described in the topic “Connections” on page 7. Ensure that the polarity is correct and that the correct end-of-line is fitted if it is required.

**Note:** Observe the polarity of the extinguishing actuator output to ensure proper operation.

**WARNING:** Risk of death or severe injury. Test the line supervision (for open and short circuit faults) and the activation function *before* connecting the extinguishing agent to the actuator.

- Any optional equipment is correctly connected. This includes fire detection devices, fire routing, alarm and fault relays, etc.

- The batteries are connected correctly, and comply with all requirements described in “Connecting the batteries” on page 18.
- All system configuration complies with the corresponding operating mode and local regulations.

## Commissioning the control panel

Once all installation, connection, and configuration requirements have been checked as described above, the control panel can be powered up.

### Normal startup

After powering up the control panel, normal status (standby) is indicated as follows:

- The Supply LED is steady
- The Fire Sounder Delay LED is steady (if a delay has been configured and enabled)
- The Fire Routing Delay LED is steady (if a delay has been configured and enabled)

If any other indicators are on, check your installation thoroughly before proceeding.

### Fault startup

In accordance with EN 54-2, the control panel has a special startup sequence that is used after an internal fault has been detected by the control panel.

This is indicated as follows:

- The general Fault LED flashes fast
- The System Fault LED flashes slow

When this happens:

1. Enter the operator user level password.
2. Press the Reset button to reset the control panel.

If the fault status persists after reset, the control panel aborts the startup sequence and turns on the System Fault LED.

When this happens, check all control panel connections and configuration, as described in “Before commissioning the control panel” on page 51.

### Battery startup

To power up the control panel from the batteries, press the battery start button on the control panel PCB (marked as BAT. START, see Figure 16 on page 53). Keep the button pressed for approximately 5 seconds.

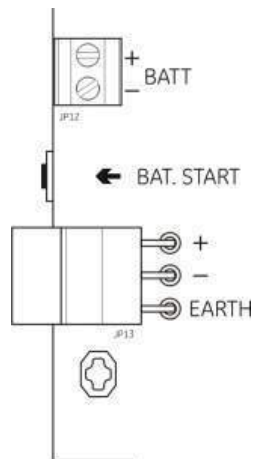
**Figure 16: Battery startup button**

## Functional tests

Create a short circuit and an open circuit in each zone to test fault reporting for both types of fault.

If available, activate a fire manual call point to test manual fire alarm reporting. The control panel should override any configured delays and activate alarm notification devices and fire routing (where applicable) immediately.

Activate a fire detector to test automatic alarm reporting. The control panel should initiate any configured delays and activate alarm notification devices and fire routing (where applicable) once the delay time has elapsed.

Verify the extinguishing functionality without connecting the extinguishing agent to the actuator. Test these functions:

- Manual (MCP Start) and automatic (extinguishing zone detectors) extinguishing activation
- Emergency override manual call points (MCP Hold and MCP Abort)
- Extinguishing activation sounders
- Remote manual-only control and safety door monitoring (if available)
- Delay to actuator activation
- Extinguishing released sounders and optical warning panels or signs are activated by the extinguishing agent flow signal (if configured)

Using a multimeter, verify that the fault relay is activated when a fault is reported and that the fire alarm relay is activated when a fire alarm is reported.

## Response times

Response times for standard events are as follows.

**Table 14: Response times for standard events**

<b>Event</b>	<b>Response time</b>
Alarm	Less than 3 seconds
Input activation	Less than 3 seconds
MCP Hold fault	Less than 2 seconds
MCP Abort fault	Less than 2 seconds
Other input faults	Less than 3 seconds
Actuator fault	Less than 30 seconds
Optical panel fault	Less than 30 seconds
Zone fault	Less than 30 seconds
Sounder fault	Less than 30 seconds
Fire routing fault	Less than 30 seconds
Earth fault	Less than 100 seconds
Battery charger fault	Less than 100 seconds
No batteries found fault	Less than 3 minutes
Mains fault	Less than 3 minutes
Low battery fault	Less than 100 seconds
Fuse/protection fault	Less than 3 minutes
System fault	Less than 100 seconds
Battery high resistance fault	Less than 4 hours

# Chapter 4

# Maintenance

## **Summary**

This chapter includes information on system maintenance and battery maintenance.

## **Content**

System maintenance	56
Quarterly maintenance	56
Annual maintenance	56
Cleaning the control panel	56
Battery maintenance	57

## System maintenance

Perform the following maintenance tasks to ensure that your fire alarm and extinguishing system works correctly and complies with all required European regulations.

---

**WARNING:** Risk of death or serious injury. Disconnect the extinguishing agent actuator from the control panel *before* you issue the actuator output test command. When you confirm the test command, the actuator output is activated immediately.

---

**Note:** Before performing any tests, ensure that fire routing (if configured) is disabled or that the fire brigade has been notified.

### Quarterly maintenance

Test at least one device per zone and verify that the control panel responds to all fault and alarm events. The control panel power supply and battery voltage should be checked.

### Annual maintenance

Test all system devices and verify that the control panel responds to all fault and alarm events. All electrical connections must be visually inspected to make sure that they are securely fastened, that they have not been damaged, and that they are appropriately protected.

### Cleaning the control panel

Keep the outside and inside of the control panel clean. Carry out periodic cleaning using a damp cloth for the outside. Do not use products containing solvents to clean the control panel. Do not clean the inside of the cabinet with liquid products.

# Battery maintenance

## Compatible batteries

The control panel requires two 12V, 7.2 or 12 Ah rechargeable sealed lead-acid batteries. Compatible batteries are shown below.

**Table 15: Compatible batteries**

12V, 7.2 Ah	BS127N Fiamm FG20721/2 Yuasa NP7-12
12V, 12 Ah	BS130N Fiamm FG21201/2 Yuasa NP12-12

## Troubleshooting batteries

Battery supply faults are indicated by a flashing Supply Fault LED. If this LED is flashing, check the following:

- That the battery cables are in good condition
- That the battery cables are connected securely and correctly at the battery and at the control panel PCB

If the cables are in good condition and all connections are correct, then the batteries should be replaced immediately.

## Replacing batteries

Batteries must be replaced periodically as recommended by the battery manufacturer. The useful life of the battery is approximately four years. Avoid the total discharge of the batteries. Always use the recommended replacement batteries.

### To replace the batteries:

1. Disconnect and remove the existing batteries from the cabinet.
2. Install and connect the replacement batteries using the bridge provided. Observe correct polarity.
3. Dispose of the batteries as required by local ordinances or regulations.





# Chapter 5

## Technical specifications

### **Summary**

This chapter includes technical specifications for your control panel.

### **Content**

Zone specifications 60

Input and output specifications 61

Power supply specifications 63

Mechanical and environmental specifications 64

## Zone specifications

**Table 16: General zone specifications**

Zone output voltage	22 VDC nominal 24 VDC max. 18 VDC min.
Current consumption (per zone)	
Standby (with 32 detectors)	2.6 mA max.
Standby (with end-of-line)	7.4 mA max.
Standby (with end-of-line)	4.6 mA nominal
Short circuit	55 mA max.
Alarm	65 mA max.
Default zone configuration	Passive end-of-line
Zone termination	4.7 k $\Omega$ 5% 1/4 W end-of-line resistor
Number of detectors per zone	
Aritech Dx700 series	20 max.
Other detectors	32 max. [1][2]
Number of manual call points per zone	32 max. [1]

[1] Or as defined by local standards.

[2] Provided that the detectors meet the required zone specifications given here.

**Table 17: Mixed zone specifications**

Resistance (per zone)	40 $\Omega$ max.
Capacitance (per zone)	500 nF max.
Nominal impedance	
Detector	160 to 680 $\Omega$ $\pm$ 5%
Manual call point	100 $\Omega$ $\pm$ 5%
Detector alarm reference range	
Zone voltage	6.5 to 14 V
Zone impedance	145 to 680 $\Omega$
Manual call point alarm reference range	
Zone voltage	3 to 6.5 V
Zone impedance	75 to 144 $\Omega$
Short circuit reference range	
Zone voltage	< 3 V
Zone impedance	< 55 $\Omega$
Open circuit reference range	
Zone impedance	> 8 k $\Omega$
Zone device current consumption	$\leq$ 2.6 mA

**Table 18: Automatic and manual zone specifications**

Resistance (per zone)	55 $\Omega$ max.
Capacitance (per zone)	500 nF max.
Nominal impedance	100 to 680 $\Omega$ $\pm$ 5%

Detector alarm reference range	
Zone voltage	3 to 14 V
Zone impedance	75 to 680 $\Omega$
Short circuit reference range	
Zone voltage	< 3 V
Zone impedance	< 55 $\Omega$
Open circuit reference range	
Zone impedance	> 8 k $\Omega$
Zone device current consumption	$\leq$ 2.6 mA

## Input and output specifications

**Table 19: Input specifications**

Number of inputs	8
Default input allocation	
IN1 (supervised)	Start extinguishing manual call point
IN2 (supervised)	Hold extinguishing manual call point
IN3 (supervised)	Abort extinguishing manual call point
IN4 (non-supervised)	Manual-only mode control
IN5 (supervised)	Low Pressure indication
IN6 (supervised)	Extinguishing Agent Flow
IN7 (supervised)	Safety door monitoring
IN8 (non-supervised)	Remote reset
Default input end-of-line (supervised inputs only)	15 k $\Omega$ 5% ¼ W passive end-of-line
Unsupervised inputs resistance values	
Activation input value	$\leq$ 9 k $\Omega$ $\pm$ 10%
Deactivation input value	> 9 k $\Omega$ $\pm$ 10%
Supervised inputs resistance values	
Short circuit	$\leq$ 62 $\Omega$
Active	> 62 $\Omega$ to 8 k $\Omega$
High impedance fault	> 8 k $\Omega$ to 10 k $\Omega$
Standby	> 10 k $\Omega$ to 21 k $\Omega$
Open circuit	> 21 k $\Omega$
Control panel input current	
Standby (with end-of-line)	1.2 mA nominal
Activated	5.3 mA max.
Open circuit	100 $\mu$ A nominal
Short circuit	5.75 mA max.
Low pressure input impedance values	
Configured as normally closed	Standby: > 62 $\Omega$ to 8 k $\Omega$ Low pressure: > 10 k $\Omega$ to 21 k $\Omega$
Configured as normally open	Low pressure: > 62 $\Omega$ to 8 k $\Omega$ Standby > 10 k $\Omega$ to 21 k $\Omega$

**Table 20: Output specifications**

Number of outputs	8
Outputs functionality:	
OUT1 (non-supervised)	Hold manual call point
OUT2 (non-supervised)	Abort manual call point
OUT3 (non-supervised)	Manual-only mode
OUT4 (non-supervised)	Released
OUT5 (standard supervision)	Fire sounders
OUT6 (standard supervision)	Extinguishing sounders
OUT7 (standard supervision)	Released optical warning panels or signs
OUT8 (extinguishing EOL supervision)	Actuator
Outputs EOL (end-of-line)	
OUT1 to OUT4	Not required
OUT5 to OUT7	15 K $\Omega$ 1/4 W end-of-line resistor
OUT8	2010EXT-EOL end-of-line board
Non-supervised outputs	
Number of outputs	4 (OUT1 to OUT4)
Output type	Free-of-voltage switch (galvanic isolated)
Output inactive	open circuit
Output active	short circuit
Current rating (when switch on)	2 A max. at 30 VDC
Standard supervised outputs	
Number of outputs	3 (OUT5 to OUT7)
Output type	24 VDC supervised output
Output inactive	-10 to -13 VDC (reverse polarity supervision)
Output active	21 to 28 VDC (24 VDC nominal)
Current rating (when active)	500 mA max. at 25°C 385 mA max. at 40°C
Start-up current rating	1.35 A start-up current ( $t \leq 10.5$ ms) at -5 °C 1.47 A start-up current ( $t \leq 8.75$ ms) at +25 °C 1.57 A start-up current ( $t \leq 7.70$ ms) at +50 °C
Actuator output specifications	
Number of outputs	1 (OUT8)
Output type	24 VDC supervised output
Output inactive	-10 to -13 VDC (reverse polarity supervision)
Output active	21 to 28 VDC (24 VDC nominal)
Current rating (when active)	750 mA max. at 25°C 650 mA max. at 40°C
Start-up current rating	2.63 A start-up current ( $t \leq 10.5$ ms) at -5 °C 2.50 A start-up current ( $t \leq 9.86$ ms) at 25 °C 2.38 A start-up current ( $t \leq 8.73$ ms) at 50 °C
Alarm relay output	
Number of potential-free contacts	2 (normally-open NO and normally-closed NC)
Current rating (when active)	2 A max. at 30 VDC
Fault relay output	
Number of potential-free contacts	2 (normally-open NO and normally-closed NC)
Current rating (when active)	2 A max. at 30 VDC
Output active (energized)	No fault (short between C and NO contacts)
Auxiliary 24 VDC output	
Output voltage	21 to 28 VDC (24 VDC nominal)
Output current	250 mA max.

# Power supply specifications

**Table 21: Mains supply specifications**

Operating voltage	110 VAC / 60 Hz or 240 VAC / 50 Hz
Rated current	
110 VAC	3.15 A
240 VAC	1.5 A
Voltage tolerance	+10% / -15%
Mains fuse	
110 VAC	T 3.15A 250V
240 VAC	T 2A 250V

**Table 22: 24 VDC power supply specifications**

DC voltage	24 V
Rated current	4 A
Current range	0 to 4 A
Rated power	100 W
Voltage tolerance	±2%

**Table 23: Batteries and battery charger specifications**

Batteries	2 × 7.2 Ah or 2 × 12 Ah
Battery type	Sealed lead-acid
Battery charger voltage	27.3 V at 20°C -36 mV/°C
Battery charger current	0.7 A max.
Out of service voltage level	< 22.75 V
No operation voltage level	< 21 V

**Table 24: Expansion board current consumption [1]**

Number of expansion boards	Up to 4
2010-1-SB output specifications	
Number of outputs	4 (OUT1 to OUT4)
Output type	24 VDC supervised output
Output inactive	-10 to -13 VDC (reverse polarity supervision)
Output active	21 to 28 VDC (24 VDC nominal)
Current rating (when active)	250 mA max.
Current consumption (standby)	15 mA at 24 VDC
Internal power mode current rating	300 mA max for all expansion boards
External power mode current rating	1 A max per expansion board

<b>2010-1-RB output specifications</b>	
Number of outputs	4 (OUT1 to OUT4)
Output type	Free-of-voltage relay
Number of potential-free contacts	2 (normally-open NO and normally-closed NC)
Current rating (when active)	2 A max. at 30 VDC
Current consumption (standby)	15 mA at 24 VDC
Current consumption (active)	50 mA (all outputs) at 24 VDC

[1] Optional expansion board not supplied with control panel.

**Table 25: Power supply equipment specifications for EN 54-4**

Current consumption (I <sub>min</sub> ) [1]	0.05 A min.
Current consumption in standby (I <sub>min a</sub> )	0.39 A max.
Current consumption in alarm (I <sub>max b</sub> )	2.78 A max.

[1] All zones and inputs in standby, no outputs activated, no expansion boards installed, no 24V auxiliary used and batteries fully charged.

## Mechanical and environmental specifications

**Table 26: Mechanical specifications**

Cabinet dimensions without cover	421 × 100 × 447 mm
Weight without batteries	3.9 kg
Number of cable knockouts	20 x Ø 20 mm at top of cabinet 2 x Ø 20 mm at bottom of cabinet 26 x Ø 20 mm at rear of cabinet
IP rating	IP30

**Table 27: Environmental specifications**

Environmental class	Class A
Operating temperature	-5 to +40°C
Storage temperature	-20 to +70°C
Relative humidity	10 to 95% noncondensing
Type class conditions	3K5 of IEC 60721-3-3

Figure 17: Control panel cabinet without cover

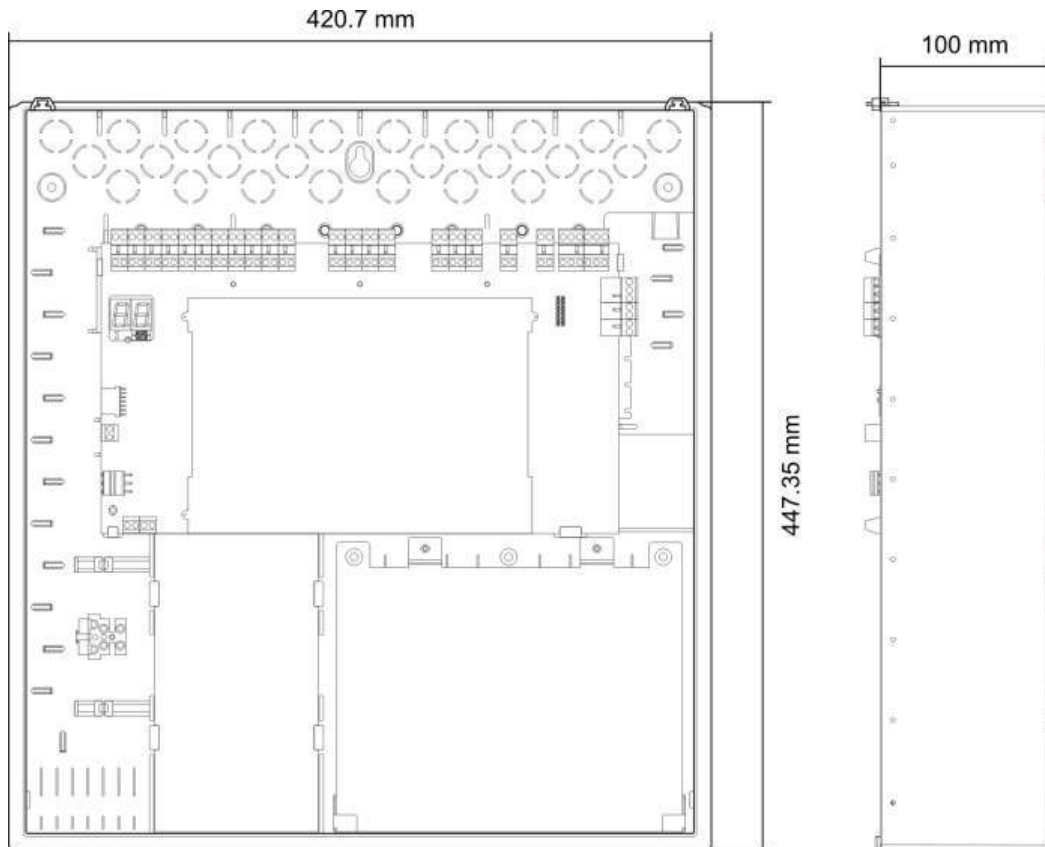
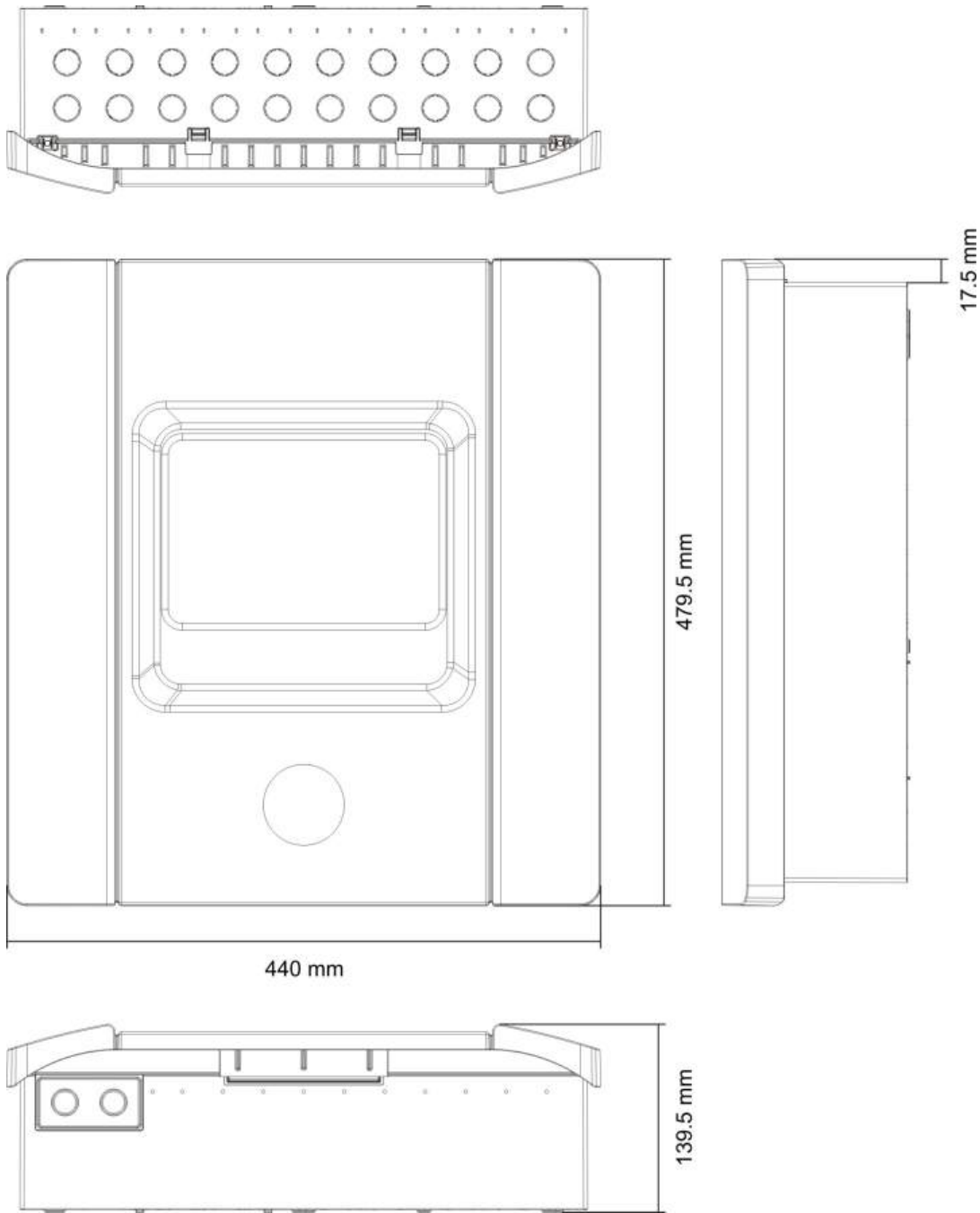

Figure 18: Control panel cabinet with cover





# Appendix A

## Configuration presets

### Summary

This section includes detailed information on operating mode and expansion board configuration presets.

### Content

Input and output configuration	68
Default delays	68
Basic configuration modes	68
Basic standard mode	68
Basic evacuation mode	69
Expansion board functions	69

# Input and output configuration

**Table 28: Inputs and outputs**

IN1	Start MCP	Supervised
IN2	Hold MCP	Supervised
IN3	Abort MCP	Supervised
IN4	Manual-only mode activation	Unsupervised
IN5	Low pressure indication	Supervised
IN6	Extinguishing agent flow	Supervised
IN7	Safety door fault monitor	Supervised
IN8	Remote reset	Unsupervised
OUT1	Hold MCP	Unsupervised
OUT2	Abort MCP	Unsupervised
OUT3	Manual-only mode	Unsupervised
OUT4	Extinguishing released	Unsupervised
OUT5	Fire sounders	Supervised
OUT6	Extinguishing sounders	Supervised
OUT7	Extinguishing released optical warning panels or signs	Supervised
OUT8	Actuator	Supervised

## Default delays

**Table 29: Default delay configuration**

Fire sounders delay	0
Fire routing delay [1]	0
Zone delay	0n
Released delay	10 seconds

[1] Requires installation of optional 2010-1-SB expansion board (not supplied).

## Basic configuration modes

### Basic standard mode

Fire sounders cannot be manually activated in this operating mode (fire sounders are only activated if there is a fire alarm).

The configured actuator delay is applied when the MCP Start is activated.

**Table 30: Presets and zone characteristics**

Preset	Zone description	Zone detection
01	Passive	Z1 and Z2 automatic, for extinguishing event Z3 mixed, for fire detection
02	Passive, CleanMe enabled	Z1 and Z2 automatic, for extinguishing event Z3 mixed, for fire detection

## Basic evacuation mode

Fire sounders can be manually activated at the operator user level in this operating mode (a fire alarm is not required).

The actuator is activated immediately when the MCP Start is activated.

**Table 31: Presets and zone characteristics**

Preset	Zone description	Zone detection
04	Passive	Z1 and Z2 automatic, for extinguishing event Z3 mixed, for fire detection
05	Passive, CleanMe enabled	Z1 and Z2 automatic, for extinguishing event Z3 mixed, for fire detection

## Expansion board functions

**Table 32: Expansion board functions**

Preset	ON status	Output	Delay
01	Z1 alarm	1	Yes
	Z2 alarm	2	Yes
	Z3 alarm	3	Yes
05	Z1 alarm	1	Yes
		2	Yes
	Z2 alarm	3	Yes
		4	Yes
06	Z3 alarm	1	Yes
		2	Yes
22	Z1 and Z2 alarm	1	Yes
		2	Yes
	Z2 and Z3 alarm	3	Yes
		4	Yes

<b>Preset</b>	<b>ON status</b>	<b>Output</b>	<b>Delay</b>
23	Z1 or Z2 alarm	1	Yes
		2	Yes
	Z2 or Z3 alarm	3	Yes
		4	Yes
24	Fire alarm	1	No
		2	No
		3	No
		4	No
25	Fault	1	No
		2	No
		3	No
		4	No
26	Fire alarm	1	No
		2	No
	Fault	3	No
		4	No
27	Fire alarm	1	No
	Fault	2	No
	Buzzer ON	3	No
	Reset ON	4	No
29	Fault [1]	1	No
		2	No
		3	No
		4	No
30	Fire alarm	1	No
		2	No
	Fault [1]	3	No
		4	No
31	Fire alarm	1	No
	Fault [1]	2	No
	Buzzer ON	3	No
	Reset ON	4	No
33	Buzzer ON	1	No
		2	No
	Reset ON	3	No
		4	No

Preset	ON status	Output	Delay
41	Fire alarm	1	Yes
	Extinguishing activation	2	Yes
	Extinguishing preactivation	3	Yes
	Extinguishing released	4	Yes
42	Hold ON	1	Yes
	Abort ON	2	Yes
	Manual-only mode	3	Yes
	Manual-automatic mode	4	Yes
43	Extinguishing activation disabled	1	Yes
	Pressure low fault	2	Yes
	Safety door fault	3	Yes
	Extinguishing agent flow ON	4	Yes
44	Extinguishing activation	1	Yes
		2	Yes
	Extinguishing released	3	Yes
		4	Yes
45	Fire sounders [2]	1	Yes
	Extinguishing sounders [2]	2	Yes
	Extinguishing released optical warning [2]	3	Yes
	Actuator ON [2]	4	Yes
80	Fire routing ON	1	No
		2	No
		3	No
		4	No
90	Fire Sounders ON	1	No
		2	No
	Extinguishing sounders ON [3]	3	No
		4	No
91	Fire Sounders ON	1	No
		2	No
		3	No
		4	No
92	Extinguishing sounders ON	1	No
		2	No
		3	No
		4	No

Preset	ON status	Output	Delay
96	Extinguishing activation sounders ON [3]	1	No
		2	No
	Extinguishing released sounders ON [3]	3	No

[1] Fail-safe mode (output is active when there is no fault).

[2] Faults and disable options are linked to the expansion board indications.

[3] Faults are signaled in the Extinguishing Sounders LED. Output activates continuously and the tone (for activation or released) has to be provided and configured in the sounder device.

# Appendix B

## Regulatory information

### **Summary**

This section includes regulatory information for your control panel.

### **Content**

European standards 74

## European standards

### European standards for fire control and indicating equipment

These control panels have been designed in accordance with European Standards EN 54-2, EN 54-4, and EN 12094-1.

In addition, all models comply with the following EN 54-2 and EN 12094-1 optional requirements.

**Table 33: EN 54-2 optional requirements**

Option	Description
7.8	Output to fire alarm devices [1]
7.9.1	Output to fire alarm routing equipment [2]
7.11	Delays to outputs
8.4	Total loss of power supply
10	Test condition

[1] Inputs and outputs on the optional 2010-1-SB expansion I/O board do *not* support the optional requirement of EN 54-2 clause 7.8 and should not to be used for fire alarm devices.

[2] Requires installation of optional 2010-1-SB expansion board (not supplied).

**Table 34: EN 12094-1 optional requirements**

Option	Description
4.17	Delay release of extinguishing agent
4.18	Indication of extinguishing agent flow
4.19	Monitor component status
4.20	Emergency hold device (mode A or B)
4.23	Manual mode
4.24	Trigger signals to equipment within the system
4.26	Trigger signals to equipment outside the system
4.27	Emergency abort device
4.30	Activate alarm devices with different signals

### European standards for electrical safety and electromagnetic compatibility

These control panels have been designed in accordance with the following European standards for electrical safety and electromagnetic compatibility:

- EN 60950-1
- EN 50130-4
- EN 61000-6-3
- EN 61000-3-2
- EN 61000-3-3



## European regulations for construction products

This section includes both regulatory information and a summary on the declared performance according to the Construction Products Regulation 305/2011. For detailed information refer to the product Declaration of Performance (DoP).

Certification	<b>CE</b>
Certification body	0370
Manufacturer	UTC CCS Manufacturing Polska Sp. Z o.o. Ul. Kolejowa 24. 39-100 Ropczyce, Poland  Authorized EU manufacturing representative: UTC Fire & Security B.V., Kelvinstraat 7,6003 DH Weert, The Netherlands
Year of first CE marking	11
Declaration of Performance number	360-3106-0299
Product identification	See model number on product identification label
Intended use	See DoP point 3
Essential characteristics	See DoP point 9



# Index

## 2

24 VDC power supply specifications, 63

## A

activation tone, 38  
actuator delay, 31  
actuator delay for start MCP, 41  
adding an expansion board, 49  
adding expansion boards, 33  
advanced configuration, 34  
advanced configuration menu, 34  
advanced installer user, 24  
advisory messages, ii  
annual maintenance, 56  
automatic and manual zone specifications, 60  
auxiliary 24 V reset, 48

## B

basic configuration, 28  
basic configuration menu, 28, 29  
basic configuration modes, 68  
basic default configuration, 29  
basic evacuation mode, 69  
basic installer user, 24  
basic standard mode, 68  
batteries and battery charger specifications, 63  
battery maintenance, 57  
battery startup, 52  
before commissioning the control panel, 51

## C

cabinet installation, 5  
changing user level passwords, 47  
cleaning the control panel, 56  
commissioning, 51  
commissioning the control panel, 52  
common configuration tasks, 27  
compatible batteries, 57  
configuration controls, 25  
configuration overview, 25  
configuration, software, and PCB identification, 48  
connecting a low pressure indication switch, 12

connecting a remote reset device, 13  
connecting a safety door fault monitoring device, 13  
connecting alarm and fault relays, 19  
connecting an external device for manual-only mode control, 12  
connecting an extinguishing agent flow device, 12  
connecting auxiliary equipment, 18  
connecting extinguishing system manual call points, 11  
connecting fire alarm manual call points, 9  
connecting fire detectors, 9  
connecting free-of-voltage outputs, 14  
connecting inputs, 10  
connecting other equipment, 18  
connecting outputs, 14  
connecting standard supervised outputs, 15  
connecting the batteries, 18  
connecting the extinguishing actuator output, 16  
connecting the mains power supply, 16  
connecting zones, 8  
connecting zones with initiating devices, 7  
connections, 7  
control panel cabinet layout, 4  
control panel cabinet with cover, 66  
control panel cabinet without cover, 65  
custom panel operating mode, 31

## D

default delays, 68

## E

EN 12094-1 optional requirements, 74  
EN 54-2 optional requirements, 74  
environmental specifications, 64  
European regulations for construction products, 75  
European standards, 74  
European standards for electrical safety and electromagnetic compatibility, 74  
European standards for fire control and indicating equipment, 74  
expansion board configuration, 49

expansion board configuration options, 50  
 expansion board current consumption, 63  
 expansion board function, 50  
 expansion board function and delay configuration, 50  
 expansion board functions, 69  
 expansion board labels, 49  
 expansion board output delay, 50  
 extinguishing agent flow, 42  
 extinguishing zones, 39

## F

fault startup, 52  
 fire alarm manual call point resistance values, 9  
 fire delay operation, 33  
 fire routing delay, 32  
 fire sounder operation during a zone test, 43  
 fire sounder re-sound, 43  
 fire sounders delay, 32  
 fire Sounders silence disabled time, 44  
 fixing the cabinet to the wall, 5  
 front panel configuration controls, 26  
 functional tests, 53

## G

general zone specifications, 60

## H

hold mode, 38

## I

important information, ii  
 input and output configuration, 68  
 input and output specifications, 61  
 input functionality, 10  
 input specifications, 61  
 input termination, 10  
 inputs and outputs, 68

## L

limitation of liability, ii  
 line resistance, 8

## M

mains supply specifications, 63  
 manual-only mode local, 40  
 mechanical and environmental specifications, 64  
 mechanical specifications, 64  
 mixed zone specifications, 60  
 mode and value LEDs, 26

## N

normal startup, 52

## O

operating mode configuration presets, 30  
 operator user, 24  
 output functionality, 14  
 output specifications, 62

## P

panel mode, 30  
 power supply equipment specifications for EN 54-4, 64  
 power supply specifications, 63  
 preparing the cabinet, 5  
 presets and zone characteristics, 69  
 pressure switch type, 37  
 product compatibility, 2  
 product description, 2  
 public user, 24

## Q

quarterly maintenance, 56

## R

recommended cables, 7  
 released tone, 39  
 replacing batteries, 57  
 reset disabled delay, 31  
 response times, 54  
 response times for standard events, 54

## S

safety door fault delay, 37  
 safety door monitoring, 36  
 selecting 115 or 230 VAC operation, 17  
 seven-segment display, 26  
 software compatibility, ii  
 system maintenance, 56

## T

terminating zones, 9  
 troubleshooting batteries, 57

## U

user interface, 23  
 user level passwords and indications, 24, 25  
 user levels, 24

## V

visible indications for current value and selected value, 28

**W**

where to install the cabinet, 5

**Z**

zone configuration, 7, 45

zone delay, 45

zone line resistance values, 8

zone specifications, 60

zone termination, 9

zone type, 46





