



BOSCH

AVIOTEC IP starlight 8000

FCS-8000-VFD-B / Firmware 6.5x



en

Operation manual

Table of contents

1	Safety instructions	5
1.1	General Safety Messages / Notices	5
2	Introduction	8
2.1	Disclaimer	8
2.2	About this manual	8
2.3	Conventions in this manual	8
2.4	Definition of optical terms	8
2.4.1	Illumination	8
2.4.2	Focal length	9
2.4.3	Monitoring Area	10
2.4.4	Different angle types	10
3	System Overview	13
3.1	Camera	13
3.1.1	Power supply	13
3.1.2	Uninterruptible Power Supply	14
3.2	Algorithm	14
3.2.1	Flame detection characteristics	14
3.2.2	Smoke detection characteristics	15
3.3	Intelligent Video Analytics	18
3.4	Video Management System	19
4	Planning	20
4.1	Influencing factors at the installation site	20
4.2	Minimum distances	24
4.3	Maximum distances	25
4.4	Image margin area	26
4.5	Immediate environment of the camera	28
4.5.1	Illumination and brightness	28
4.5.2	Privacy protection	28
5	Installation	29
5.1	Lens mounting	29
5.2	Camera mounting	31
5.3	Setting the field of view	31
5.4	Wiring of the camera	33
6	Camera integration	35
6.1	Local Area Network	36
6.2	Local Area Network with recording solution	36
6.3	Monitoring Center	37
6.4	Fire Alarm Control Panel	37
6.5	Mobile Devices	40
7	Access via web interface	42
8	Adjustment of detection settings	43
8.1	General settings	43
8.2	Adjustments of image regions	44
8.3	Relay settings	46
9	Troubleshooting	48
9.1	False Alarms	48
9.1.1	Quick solution to solve false alarms	48
9.1.2	False alarms under 4 seconds concerning the whole detection area	48

9.1.3	False alarms at small constant areas	48
9.1.4	Vibrations at the camera site	49
9.2	No alarm transmission	49
9.3	No fire detection	49
9.4	Image quality	49
9.5	Camera	50
10	Maintenance	51
10.1	Cleaning	51
10.2	Repair	51
10.3	Reset	51
10.4	Maintenance intervals	51
11	Technical data	53
12	Appendices	55
12.1	Maximum detection distances for margin areas	55
12.1.1	Flame detection	56
12.1.2	Smoke detection	58
12.2	Commissioning report	60
	Index	68

1 Safety instructions

In this document, the following symbols and notations are used to draw attention to special situations:

**Danger!**

Indicates a hazardous situation which, if not avoided, will result in death or serious injury.

**Warning!**

Indicates a hazardous situation which, if not avoided, could result in death or serious injury.

**Caution!**

Indicates a hazardous situation which, if not avoided, could result in minor or moderate injury.

**Notice!**

Indicates a situation which, if not avoided, could result in damage to the equipment or environment, or data loss.

1.1 General Safety Messages / Notices

**Warning!**

Do not moisten the electronic appliances inside of the lens.
It may cause fire or electric shock. In this case, shut off the power supplied to the lens immediately.

**Caution!**

The Low Voltage power supply unit must comply with EN/UL 60950. The power supply must be a SELV-LPS unit or a SELV - Class 2 unit (Safety Extra Low Voltage - Limited Power Source).

**Caution!**

Installation should only be performed by qualified service personnel in accordance with the National Electrical Code (NEC 800 CEC Section 60) or applicable local codes.

**Caution!**

Do not leave or store the lens under direct sunshine.
The lens may focus rays of light on a near-by object and cause fire.

**Caution!**

In case of unusual behavior, smoke, noise or smell coming out of the lens, shut off the power immediately and pull out the lens cable.
Notify the installer or sales agent from which you purchased the product.

**Notice!**

Avoid obstructions in the field of view!
Covered fires cannot be detected correctly. An unobstructed view of the detection area is necessary.

**Notice!**

Activating video-based fire detection sets camera settings to a specific preset.
This preset affects several camera settings as long as this mode is activated.

**Notice!**

No detection of moving fire.
Moving fires will not be detected by the video-based fire detection.

**Notice!**

Indoor use only.
This product is designed for indoor use only. Outdoor use is not allowed.

**Notice!**

No direct connection to fire services in EN54 compliant installations.
Authorities can allow a connection to fire services after verifying alarms in a monitoring center.

**Notice!**

Minimum Illumination required.
To ensure the proper functioning of the video-based fire detection algorithm, a minimal illumination of 7 lx is required.

**Notice!**

No existing standards.
There are no existing EN standards concerning the video-based fire detection.

**Notice!**

Calm wind conditions only.
Strong air currents can cause false alarms by raising dust or debris similar in appearance to fire and smoke.

**Notice!**

Respect data protection.
The relevant data protection and privacy rules are to be complied with.

**Notice!**

Avoid backlight.
Backlight can disturb the video-based fire detection algorithm.

**Notice!**

Optimized smoke detection.
The video-based fire detection algorithm is optimized for smoke of smoldering fires.

**Notice!**

Qualified personnel only.
Assembly and installation must only be performed by qualified personnel.

**Notice!**

Reduced detection distances at image margin area.
Due to optical distortion of the lens, the maximum detection distances at the image margin area are reduced.

**Notice!**

Avoid image regions with continuous upward motion.
Continuous upward motion might lead to false alarms.

**Notice!**

Make sure the camera is firmly mounted.
Camera shake might lead to false alarms. Avoid vibrations of the camera and the camera environment.

**Notice!**

No detection of irregular expanding smoke.
Smoke plumes must rise in a constant direction with a minimum density to be detected by the video-based fire detection.

**Notice!**

Ensure that you are always using the latest version of the operation manual and the current camera firmware. The manufacturer will not be held liable for any damages resulting from the use of older versions.

**Notice!**

No detection in blinking light regions in the detection area.

2 Introduction

2.1 Disclaimer

IMPORTANT: Video fire indication systems are video content analysis systems. They give indications for fires and are designed to supplement fire detection systems and human guards in monitoring centers.

Video fire indication systems are confronted with a higher amount of challenges considering scenery and background compared to conventional fire detection systems. It cannot be granted that fire is detected in all scenery settings. Thus, the video fire detection system shall be seen as a system that enhances the probability of early fire detection, with the restriction that it might detect false alarms. It shall not be seen as a system that ensures fire detection in all possible image scenarios.

Seller does not represent that the product will prevent any personal injury or property loss by fire or otherwise; or that the product will in all cases provide adequate warning or protection. Buyer understands that a properly installed and maintained alarm may only reduce the risk of a fire or other events occurring without providing an alarm, but it is not insurance or a guarantee that such will not occur or that there will be no personal injury or property loss as a result.

Consequently, seller shall have no liability for any personal injury, property damage or other loss based on a claim the product failed to give warning.

2.2 About this manual

This manual has been compiled with great care and the information it contains has been thoroughly verified. The text was correct at the time of printing, however, the content can change without notice. Bosch Security Systems accepts no liability for damage resulting directly or indirectly from faults, incompleteness or discrepancies between this manual and the product described.

For more information please contact the nearest Bosch Security Systems location or visit www.boschsecurity.com.

All hardware and software product names used in this document are likely to be registered trademarks and must be treated accordingly.

The operation manual provides an overview of possibilities and fields of application of the video-based fire detection. It should be a guideline for customer-specific application planning.

2.3 Conventions in this manual

Terms concerning the adjustment of the smoke and flame algorithm, such as menu options, commands or text in the user interface, are written in bold.

2.4 Definition of optical terms

The reflected light coming from the field of view arrives at the camera lens. The image sensor of the camera transforms the light into electric signals. This electrical image is the basis for further data processing. This chapter contains basic descriptions of optical terms.

2.4.1 Illumination

Illumination is an important influencing factor for sensible optical systems. Natural light shows the huge range of illumination values from direct sunlight (~100.000 lx) to full moon on a clear night (~1.0 lx). A luxmeter can be used to measure the light levels.

The following table provides an overview of typical illumination values in different application areas:

Application Area	Illumination (in lx)
Storage facility	50
Process plants	200
Sales room	300
Office space	500

In general a well illuminated monitoring area is advantageous for the video-based fire detection. Backlight should be avoided.

2.4.2

Focal length

The focal length of an optical system defines the distance between a light refracting lense and the focal point. Field of view, maximum distance and field angle are dependant as shown in the graphic below.

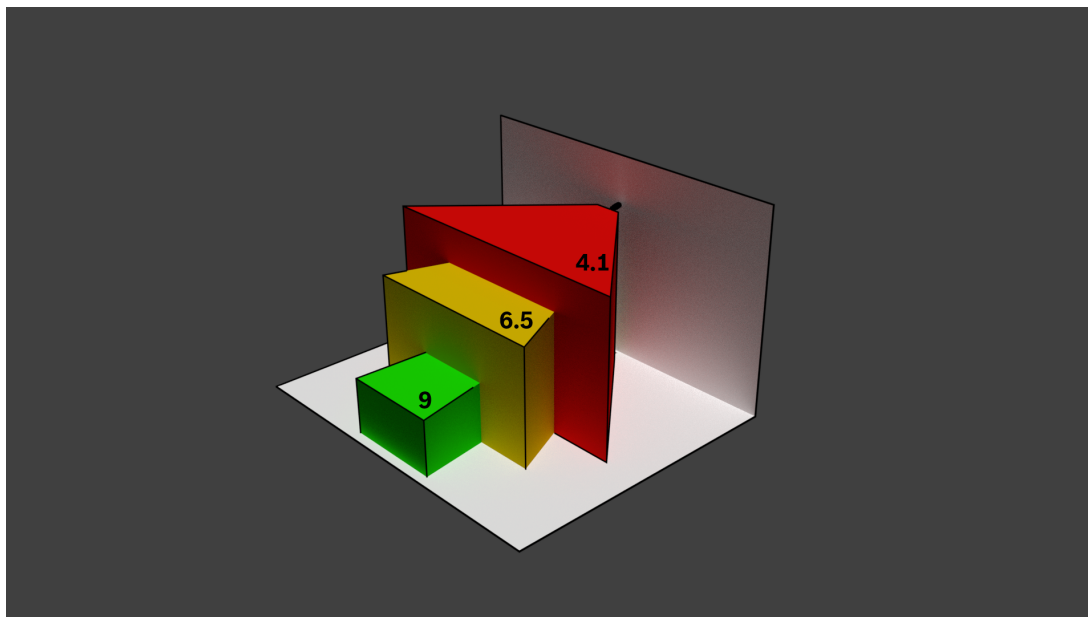

The maximum width of the field of view may be realized by the minimum focal length. This adversely affects the maximum distance to a detectable fire (red).

The maximum distance to a detectable fire may be reached by adjusting the largest focal length which decreases the width of the field of view to the minimum (green).

2.4.3 Monitoring Area

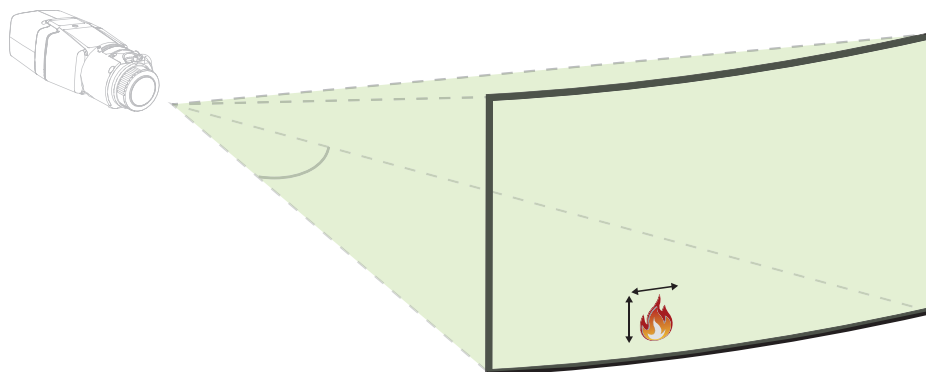

The monitoring area defines the effective space that can be observed by the video-based fire detection. It is depending on the setting of the camera lens.

See also

- *Planning, page 20*

2.4.4 Different angle types

There are different types of angles influencing the set-up of the camera. The following overview helps to get a better understanding of angles which are important for the video-based fire detection.

Angle between ground and line of sight

The angle between a fire on the ground and the line of sight to the camera is important for the flame and smoke detection. This angle needs to be 37.5% or less, otherwise flame or smoke will not be detected.

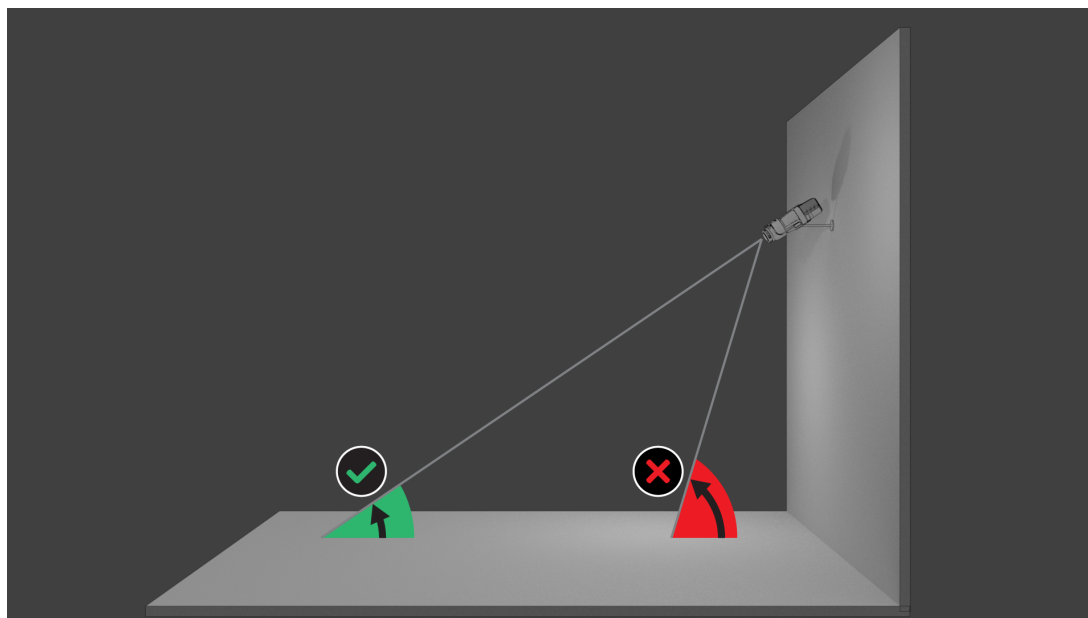

Opening angle of the lens

The opening angle of the lens can be set from wide-angle to telephoto setting. This influences the field of view of the camera.

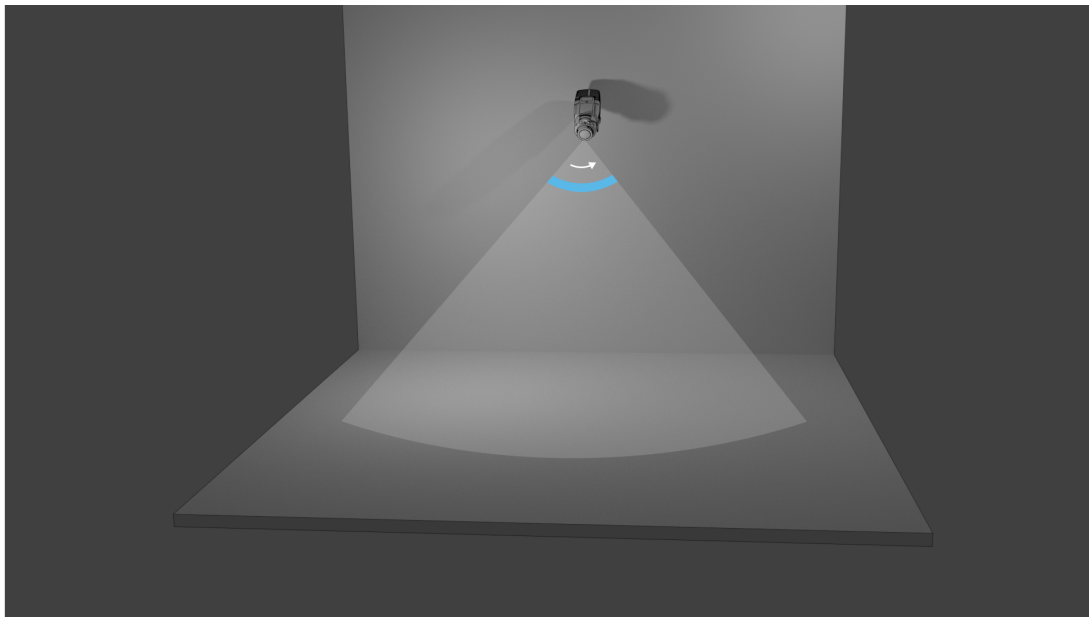

Angle for vertical alignment of the camera

The vertical alignment of the camera is also important for the video-based fire detection. A flat angle is recommended.

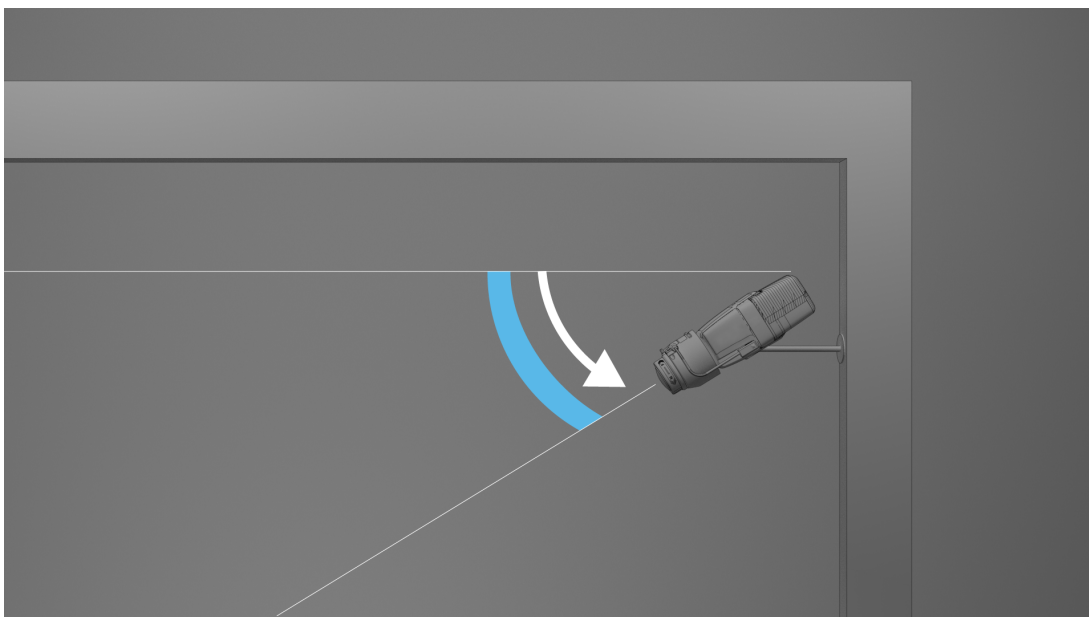

Angle for horizontal alignment of the camera

Align the camera according to your application by adjusting the angle of the horizontal alignment of the camera.

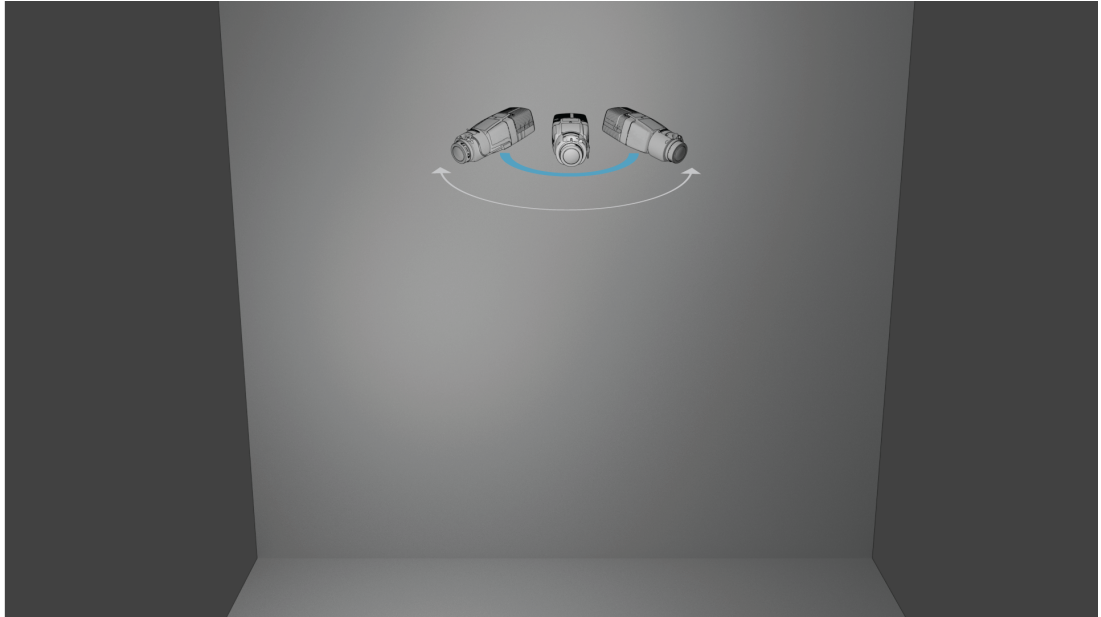

3 System Overview

The video-based fire detection is the system of choice when reliable video motion and fire detection is needed, e.g. applications which are not subjected to construction product regulation or a supplementation to existing fire detection systems. AVIOTEC IP starlight 8000 operates as stand-alone unit and doesn't need a separate evaluation unit. Furthermore, it contains all features of the Intelligent Video Analytics which allows analyzing and evaluating moving objects in parallel. Video-based fire detection and Intelligent Video Analytics operate independently from each other and are separately adjustable.

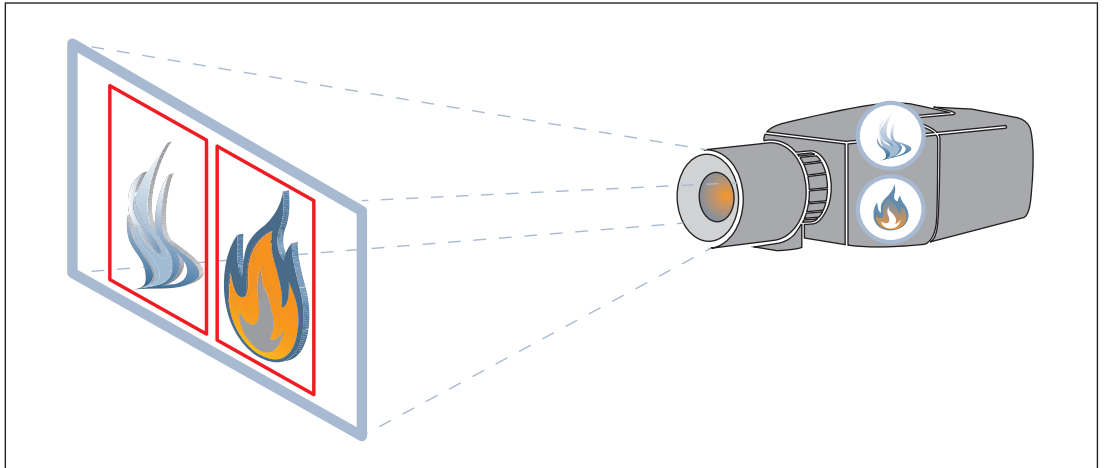

3.1 Camera

To access the features of the camera, use a web browser. The browser provides live viewing of the camera streams in the interface window, and also allows you to access and change the extensive list of settings and parameters for camera configuration. Refer to the HTML help for more information on the browser interface.

The camera recording and storage functions include local alarm recording and recording to iSCSI-based systems. Integration with many recording solutions is seamless.

The camera offers a number of flexible power and mounting options to meet your site-specific installation requirements.

3.1.1 Power supply

Power over Ethernet (PoE)



Notice!

Use only PoE approved devices.



Power-over-Ethernet (PoE) allows to use the Ethernet cabling for data transmission and for supplying power to the network device in the same cable. It is possible to realize long cable lengths in a PoE network system. The standard power supply for the video-based fire detection is Power-over-Ethernet. Alternatively, a 12 VDC power connector is available as accessory.

Power-over-Ethernet can be connected at the same time as a 12 VDC power supply. If auxiliary power (12 VDC) and PoE is applied simultaneously, the camera selects PoE and shuts off the auxiliary input.

3.1.2 Uninterruptible Power Supply

An uninterruptible power supply allows electronic devices to keep running for a short period of time when the primary power source is lost. In case of an electrical power outage, the video-based fire detection cameras will be supplied by the uninterruptible power supply.

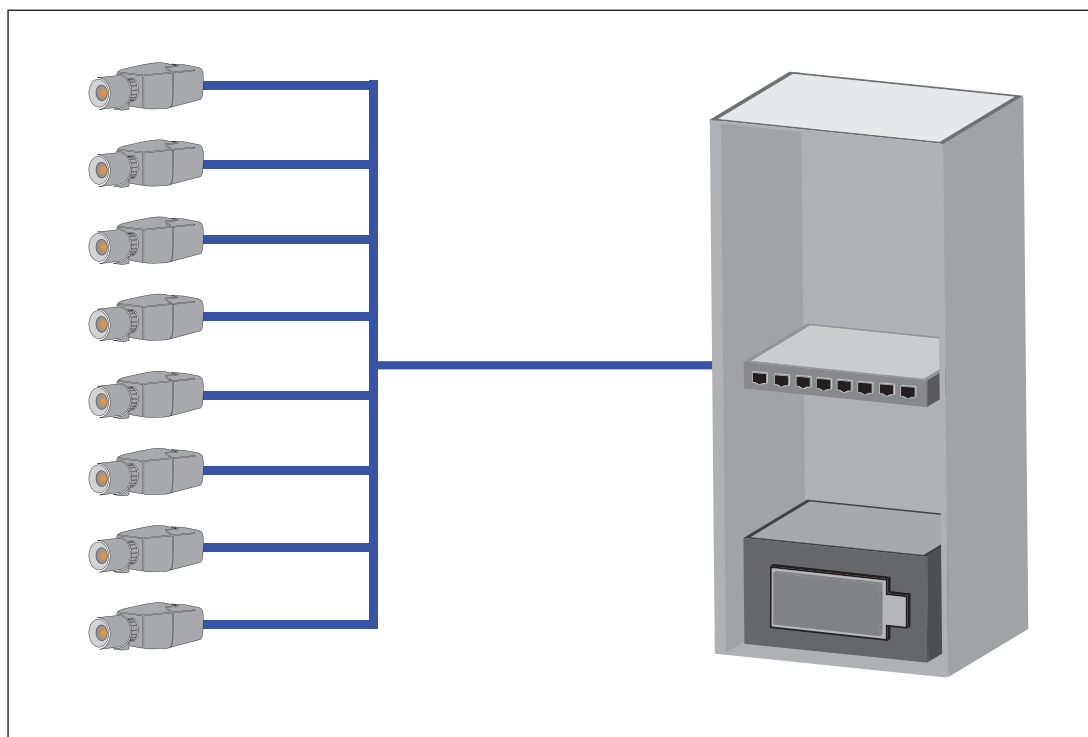

3.2 Algorithm

The intelligent smoke and flame algorithm analyzes video frames by means of characteristic and predefined patterns and variables. The fast detection algorithm is based on a real-time image processing on the camera firmware.

There are factors that can influence this kind of visual fire detection. It is important to avoid obstructions in the field of view. Sometimes obstructions cannot be prevented, e.g. building construction factors or huge machine parts. In this case it is necessary to analyze whether there is any need for further video-based fire detection cameras.

3.2.1 Flame detection characteristics

Flames will be analyzed by means of their flame color. White and orange are the basis colors for the algorithm to split off the video image into important and unimportant areas. Further flame colors will not be considered, for example a blue flame might not be detected.

Another algorithm characteristic to identify flames is the flickering of a flame. Objects with a similar movement pattern might cause false alarms, e.g. loose fluttering objects. The video-based fire detection offers subsequent adaption of flame detection settings for this purpose.

3.2.2 Smoke detection characteristics

The video-based fire detection is optimized for smoke of smoldering fires. The algorithm analyzes smoke based on physical characteristics. Typically a plume of smoke is formed in a regular upward motion of smoke at the same position. This is characterized by a thick column of smoke which is directly visible. Speed and angle of rising smoke may vary. The maximum detectable speed of upward motion is 4.2% of picture height per second. Only color-neutral smoke (white, grey, black) will be detected by the smoke algorithm.

The area in which the smoke density decreases is called ambient smoke. The smoke motion is not directly visible. Ambient smoke will not be detected.

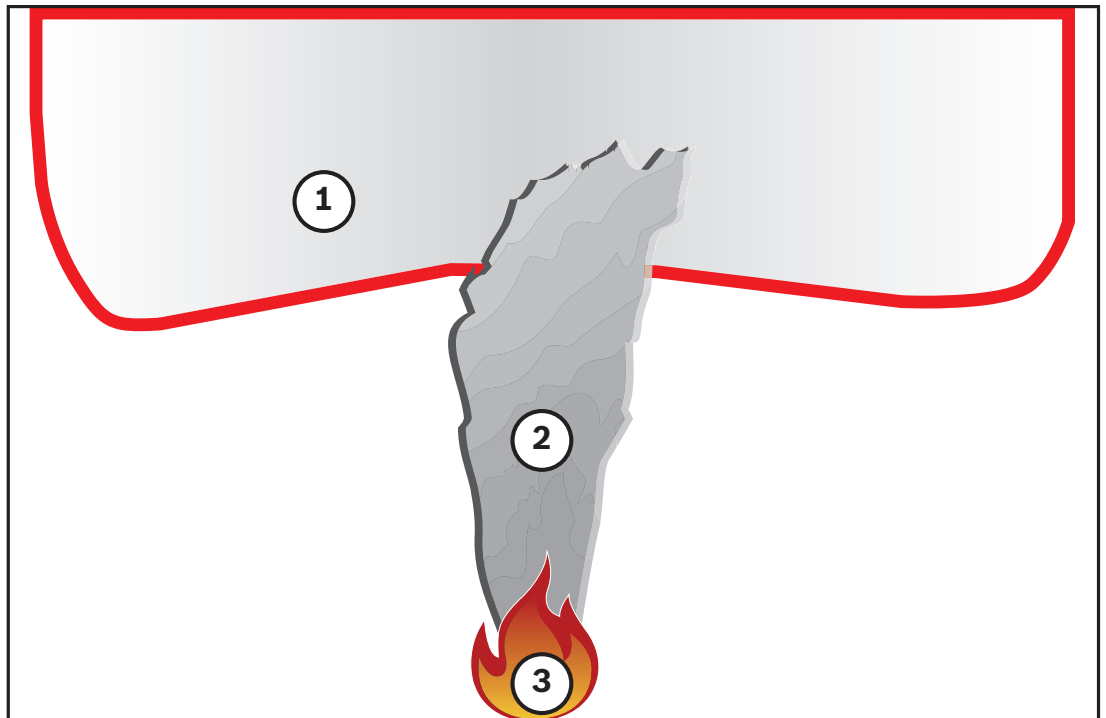

1	Ambient smoke
2	Smoke plume
3	Fire

Minimum smoke width and motion speed

A minimum rising speed of smoke is needed together with a minimum width of the smoke plume to be detected by the video-based fire detection. The minimum motion speed of smoke is 0.7% of the picture height per second and the minimum width of a smoke plume is 2.3% of the picture width. Both values have to be reached at the same location in the smoke plume. It is not sufficient to measure one value at the bottom and the other value at the top of the smoke plume.

Direction and angle of a smoke plume

The inclination angle and direction of a smoke plume are important indicators to detect smoke. In the field of view of the camera, rising smoke plumes can have a maximum tilt angle of 90° and will be detected.

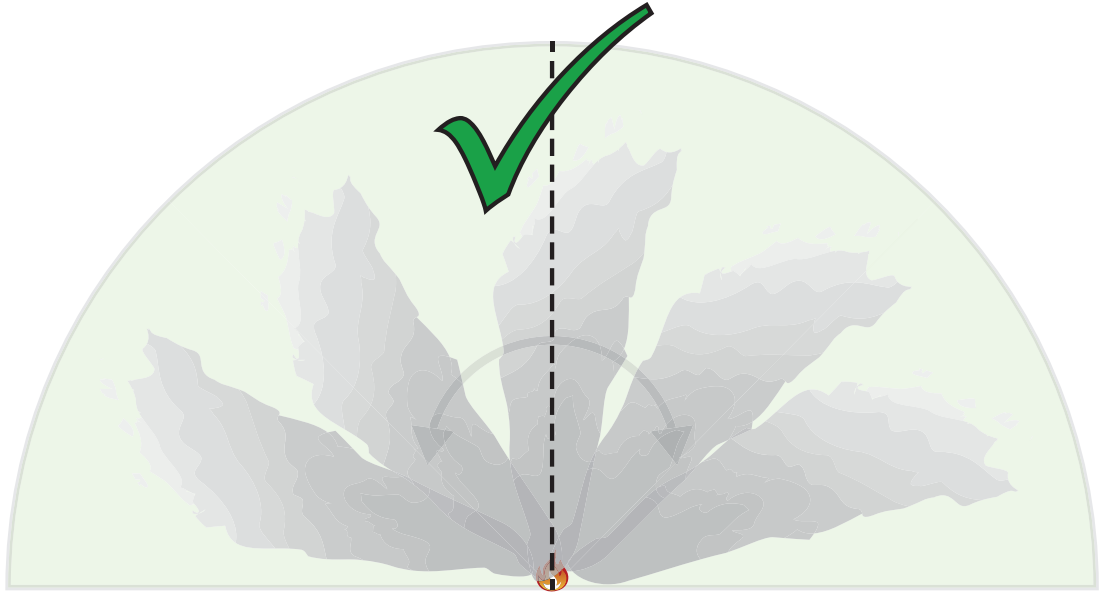

Smoke plumes must rise in a constant direction with a minimum density to be detected by the video-based fire detection. Irregular expanding smoke and smoke plumes rising in the direction of the camera might not be detected.

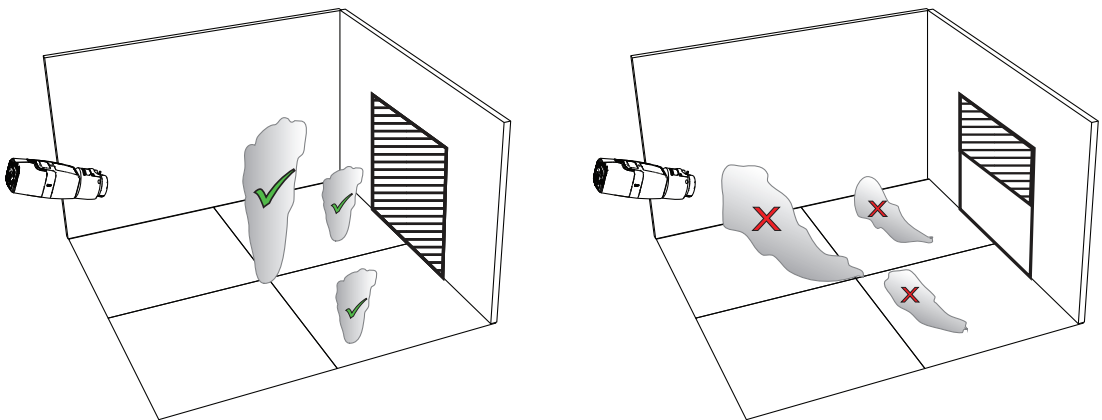

The intelligent smoke detection covers a large area of application. Nevertheless, there might be some disruptive factors in the operational environment of the customer. Objects with a similar movement pattern of smoke might cause false alarms, e.g. escalators or conveyor belts.

Smoke density

A minimum smoke density is required to identify the smoke plume.

The smoke density is described as the decrease of a local image contrast with the presence of smoke as seen in the following graphic:

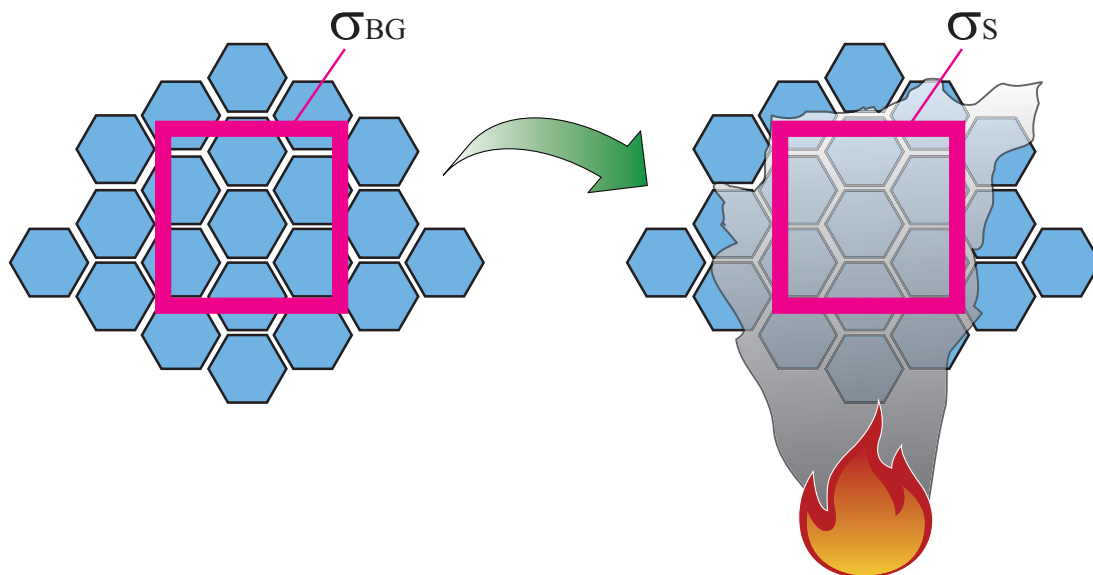

Figure 3.1: Smoke density definition

The effect of contrast reduction by smoke is described by the formula

$$d = \left(1 - \frac{\sigma_S}{\sigma_{BG}} \right) * 100\%$$

with the contrast values for a temporal average image with smoke σ_s and the contrast for the background σ_{bg} .

Exemplary images for smoke densities are shown in the following table:

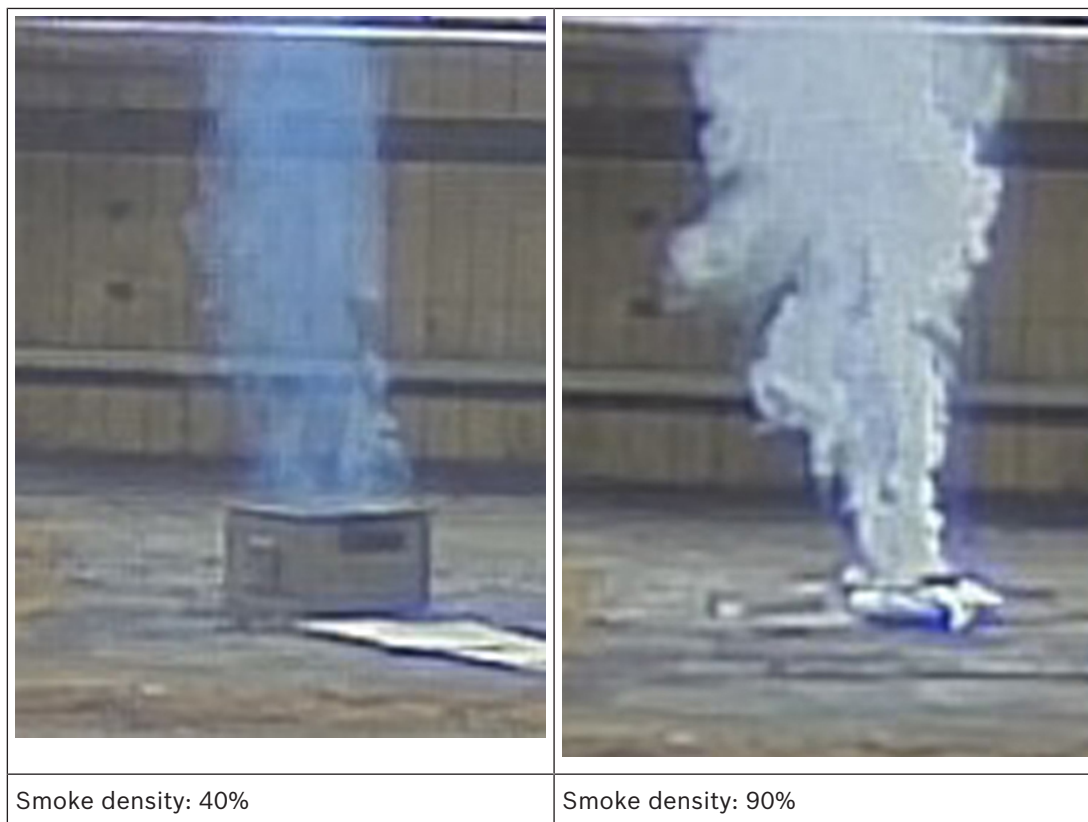

In regular conditions with an equal colored background, smoke is visible when the smoke density exceeds 40%.

In case of a background with high color saturation (e.g. deep blue) or a high background intensity or color contrast (e.g. black and white or blue and yellow) directly behind the smoke region the required smoke density can increase up to 90% before smoke is detected.

3.3 Intelligent Video Analytics

Intelligent Video Analytics is the guard-assistant system of choice when you need reliable video motion detection for indoor or outdoor use and it is state-of-the-art and reliably detects, tracks, and analyzes moving objects while suppressing unwanted alarms from spurious sources in the image.

Advanced tasks like multiple line crossing, loitering, crowd density estimation, and people counting are available. Object filter based on size, speed, direction, aspect ratio, and color can be defined.

For calibrated cameras, Intelligent Video Analytics automatically distinguishes between the object types upright person, car, bike, and truck.

The software also supports geolocation, that is it outputs tracked objects in relation to camera position for subsequent visualization on maps.

It allows you to record all of the object information and change the rules even after the fact for fully configurable forensic search.

3.4 Video Management System

A Video Management System is a unique enterprise IP video security solution that provides seamless management of digital video, audio, and data across any IP network. It nevertheless offers interfaces and standards to integrate AVIOTEC IP starlight 8000.

4 Planning

A fire safety analysis should be performed to determine the characteristics of the area including a fire load calculation. The placement of the camera or cameras results from the application environment of the customer.

4.1 Influencing factors at the installation site

You can influence some factors that might disturb the video-based fire detection algorithm. If you consider these conditions during the planning phase, you will minimize the probability of false alarms. The following information is very important to achieve an environment optimized for better and faster detection. Choose carefully the position of the camera by considering the following values:

Influencing factor	Countermeasure	Information
ILLUMINATION	Take care of a well illuminated environment. Use a luxmeter to determine the illumination values (see <i>Illumination, page 8</i>).	A well and evenly illuminated environment is important to achieve better image quality and therefore a better base for analyzing the video image.
DYNAMIC RANGE	The dynamic range in the detection area must be equal or less than factor 5. Use a luxmeter to determine the illumination values. These values have to be collected successively in the same scene.	The dynamic range represents the ratio between the minimum and maximum brightness in the environment.
BACKLIGHT	Avoid backlights in the video image by: <ul style="list-style-type: none"> – Changing the camera position and monitor in another direction. – Changing the horizontal and/or vertical tilt angle. – Excluding windows and roof lights from the field of view of the camera. 	Backlights create bright areas in the video image and can lead to false alarms. Due to the high dynamic range resulting from the backlight, fires may not be detected.

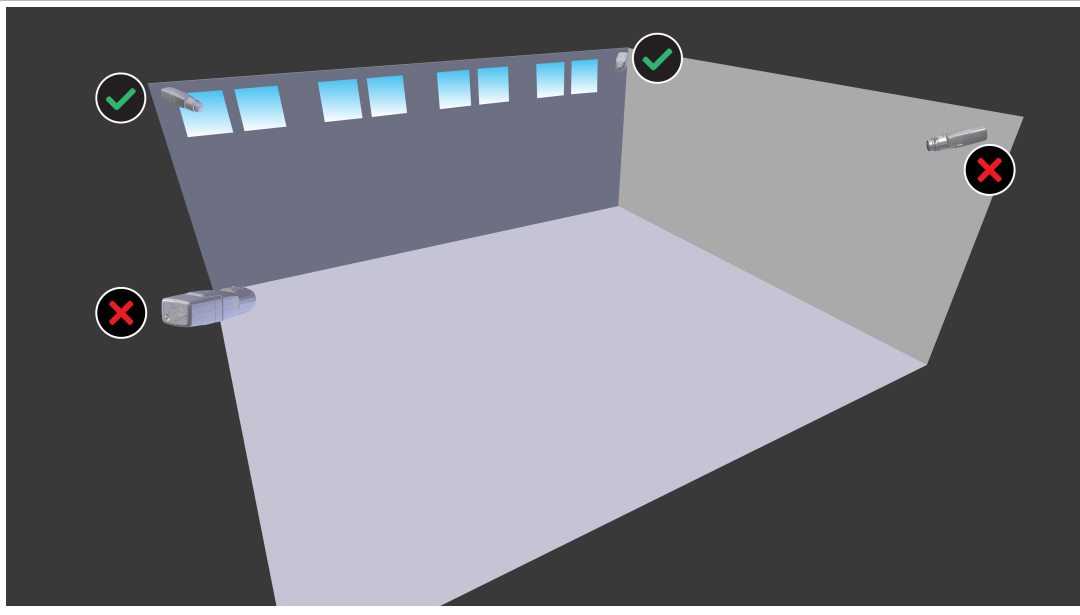
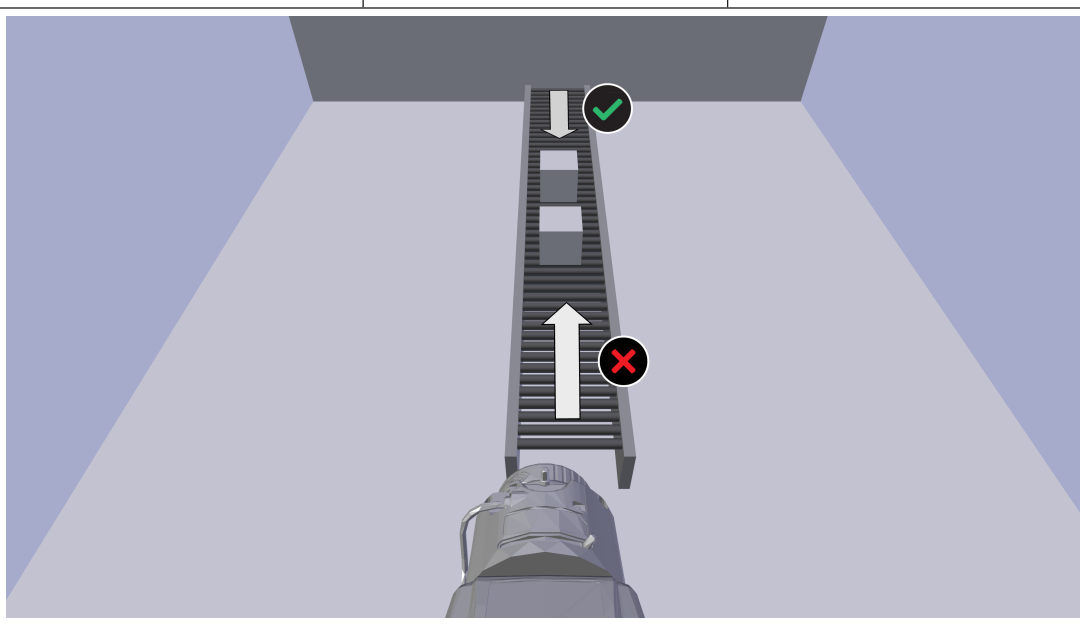
Influencing factor	Countermeasure	Information
		
<p>CONVEYOR BELTS</p>	<p>Choose a mounting position where conveyor belts are moving downwards in the picture. Exclude oblique and sideways movements in the video scene.</p>	<p>Conveyor belts moving in another direction than downwards in the picture area might be identified as smoke.</p>
		

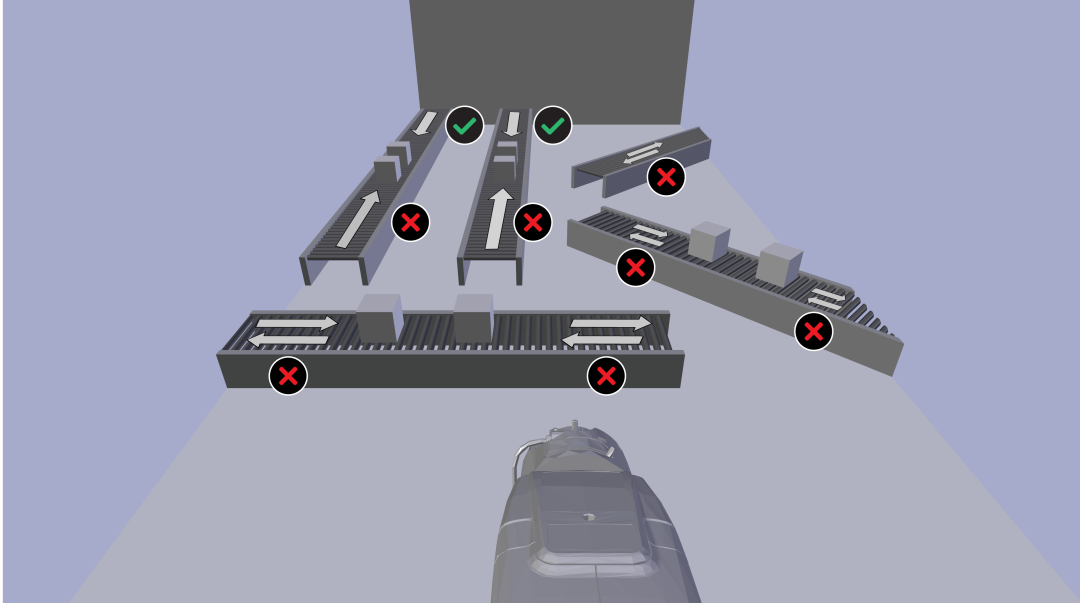
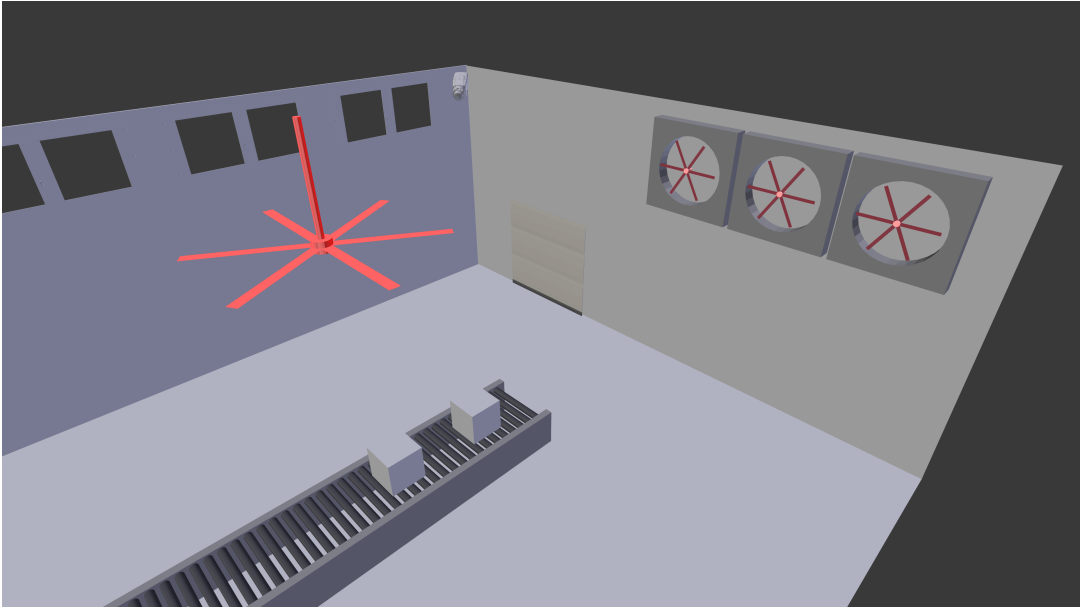
Influencing factor	Countermeasure	Information
		
<p>FANS</p>	<p>Avoid rotating fans in the field of view of the camera. Alternatively use masking (see <i>Adjustments of image regions</i>, page 44) in the configuration menu of the camera. If rotating fans can't be avoided in the scene, set Sensitivity to mid/low to suppress false alarms (see <i>General settings</i>, page 43).</p>	<p>The visible rotating fan of a ventilation system may disturb the algorithm and could result in false alarms.</p>
		

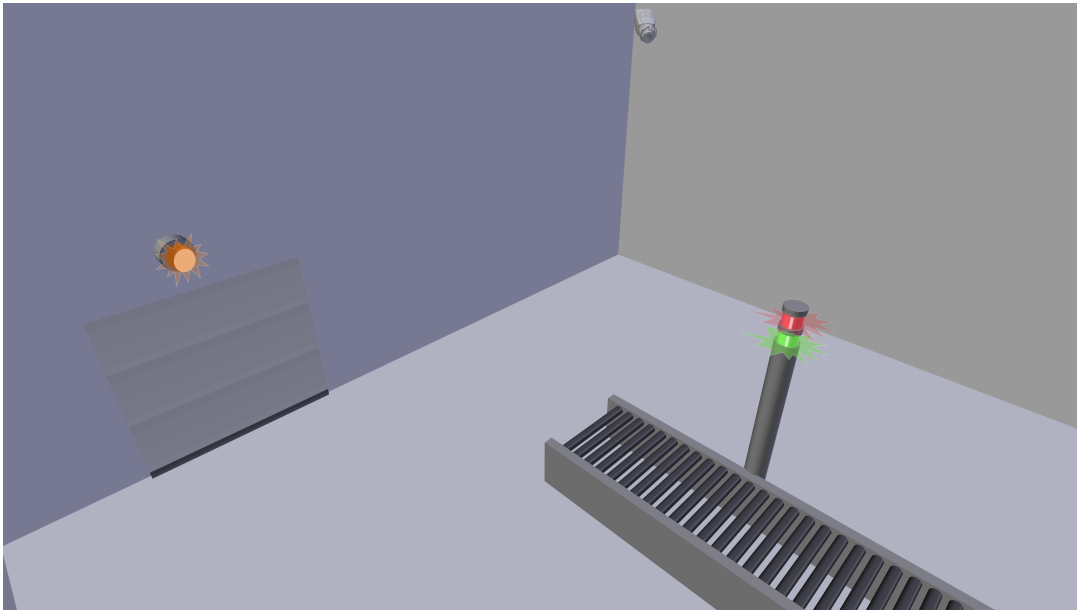
Influencing factor	Countermeasure	Information
<p>BLINKING LIGHTS</p>	<p>Check for blinking lights in your application. Use masking to exclude blinking lights from the detection or increase the verification time (see <i>Adjustments of image regions, page 44</i>). If blinking lights cause false alarms, set Sensitivity to mid/low (see chapter <i>General settings, page 43</i>).</p>	<p>Blinking lights in the detection area may disturb the algorithm and lead to false alarms.</p>
		
<p>LARGE / SLOW MOVING OBJECTS (e.g. cranes, large vehicles)</p>	<p>Avoid permanently installed and slow moving objects in the field of view of the camera. If large / slow moving objects are moving continuously in the same direction, mount the camera with view against the motion direction of the objects (like conveyor belts). In case of false alarms, set Sensitivity to mid/low (see chapter <i>General settings, page 43</i>).</p>	<p>Large, slow moving objects behind other objects may have an appearance similar to fire or smoke and lead to false alarms.</p>

Influencing factor	Countermeasure	Information
VIBRATIONS	Only mount the camera in vibration isolated areas.	Vibrations can move and shake the camera and result in false alarms.

4.2 Minimum distances

The camera must be mounted according to the following graphic:

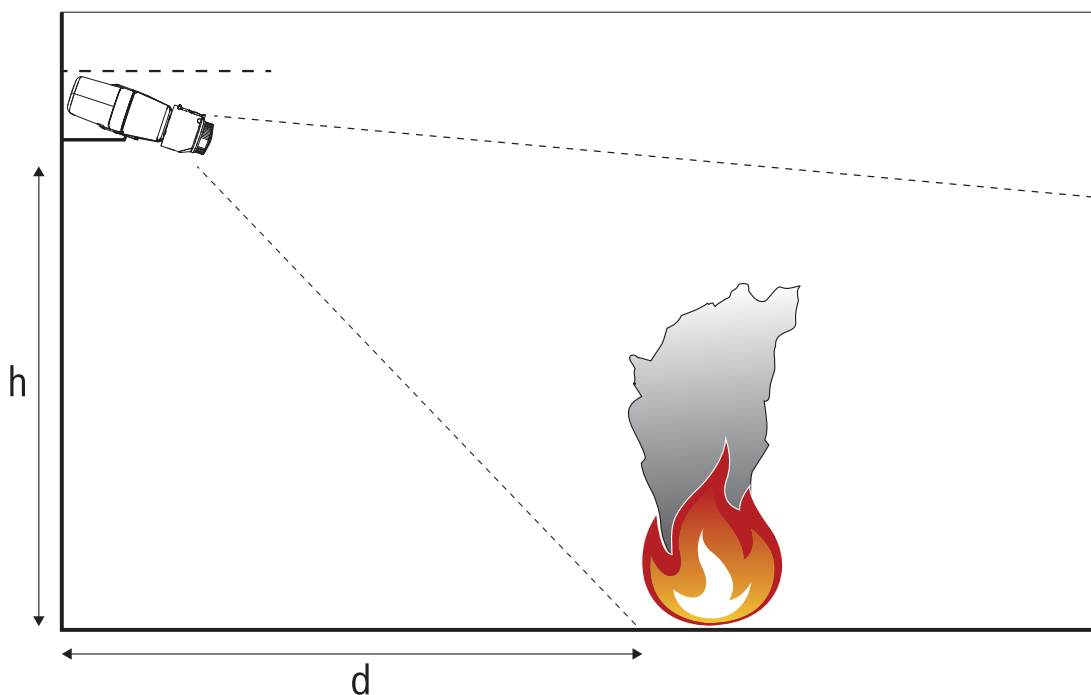

d	Minimum distance to fire
h	Installation height

The table below demonstrate exemplarily the minimum distances to fire or smoke depending on the installation height:

Installation height [m]	Minimum distance to fire [m]
2.5	3.3
3	4.0
3.5	4.6
4	5.3
4.5	6.0
5	6.6
5.5	7.3

6	8.0
6.5	8.6
7	9.3
7.5	10.0
8	10.6
8.5	11.3
9	11.9
9.5	12.6
10	13.3

Tab. 4.1: Minimum distance to fire

4.3 Maximum distances

Maximum distances

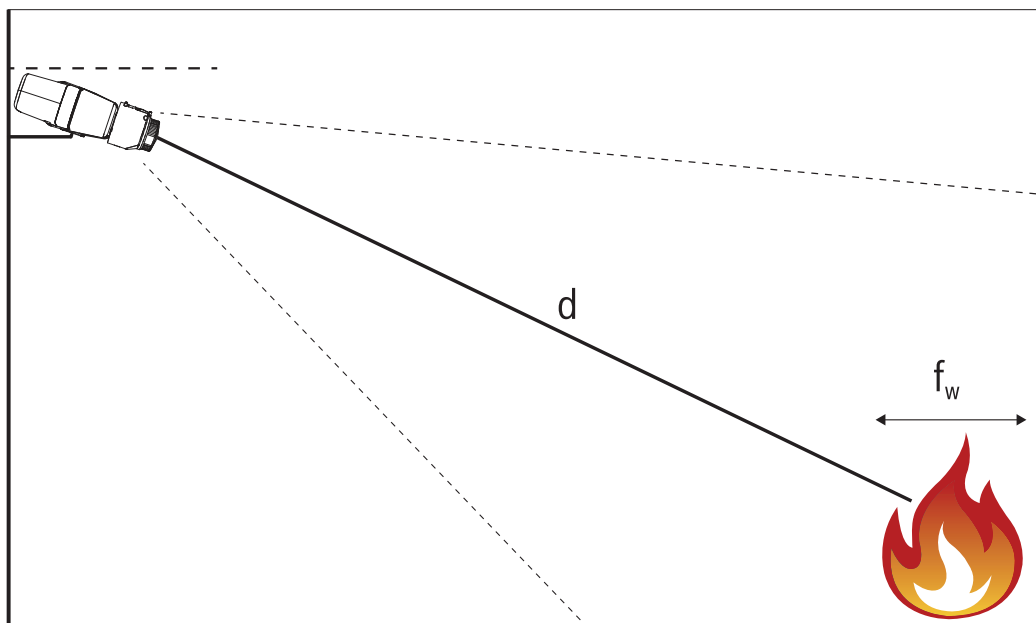

d	Maximum distance to fire
f _w	Fire width

The tables below demonstrate exemplarily the maximum distances to a fire depending on fire size and opening angle of the camera lens:

Maximum distance to fire in m (Flame detection)

Opening angle [°]

	100	60	45
Fire width [m]			
0.3	12.6	19.2	25.1
0.5	21.0	32.0	41.9
1	42.1	64.1	83.9
2	84.3	128.3	167.8

Maximum distance to fire in m (Smoke detection)

	Opening angle [°]		
	100	60	45
Smoke width [m]			
0.3	8.4	12.8	16.7
0.5	14.1	21.4	27.9
1	28.1	42.8	55.7
2	56.2	85.6	111.4

4.4 Image margin area

Due to the optical distortion of the lens, there are deviating maximum detection distances at the margin area of the picture.

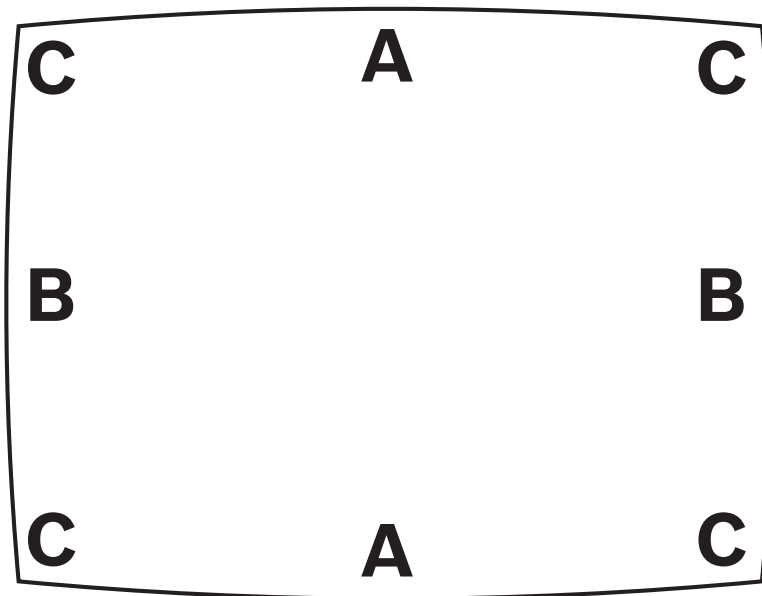

Figure 4.1: Definition of margin areas of the picture

A	Horizontal margin area
B	Vertical margin area
C	Corner area

The following table shows exemplarily the deviation in percent from the maximum detection distances at the middle of the picture:

	Margin area		
	A	B	C
Opening angle of the lens			
100°	13	40	51
90°	11	33	43
60°	5	15	20
45°	3	9	12

4.5 Immediate environment of the camera

The environment should be free from field of view disturbing elements, such as:

- Dust and humidity
- High temperature
- Steam
- Interfering influences, e.g. high radiation
- Vibrations

4.5.1 Illumination and brightness

AVIOTEC IP starlight 8000 needs a minimum illumination of 7 lx. Generally, a well illuminated monitoring area is advantageous.



Backlight should be avoided. The visibility of a smoke plume or flames decreases rapidly with increasing backlight. Try to minimize the amount of very bright background lights in your specific environment as far as it is meaningful and possible.

Dynamic range

The dynamic range is the ratio between the darkest spot compared to the lightest spot in the application. Use a luxmeter to determine the brightness in your application. The dynamic range in the camera image / the detection area must be equal or less than factor 5.

4.5.2 Privacy protection



Notice!

There is no fire detection in privacy defined masks created in the Intelligent Video Analytics.

To protect privacy, individual masks on the video screen can be defined to cover up areas in which privacy has to be guaranteed. Privacy defined masks remain stored after a reset of the camera, even after upgrading to a new firmware.

5 Installation

**Notice!**

Do not expose the image sensors to direct sunlight.
Do not obstruct the free flow of air around the camera.

**Notice!**

Avoid backlight.
Backlight can disturb the video-based fire detection algorithm.

**Notice!**

Minimum Illumination required.
To ensure the proper functioning of the video-based fire detection algorithm, a minimal illumination of 7 lx is required.

**Notice!**

Avoid obstructions in the field of view!
Covered fires cannot be detected correctly. An unobstructed view of the detection area is necessary.

**Notice!**

Avoid image regions with continuous upward motion.
Continuous upward motion might lead to false alarms.

**Notice!**

Make sure the camera is firmly mounted.
Camera shake might lead to false alarms. Avoid vibrations of the camera and the camera environment.

5.1 Lens mounting

**Notice!**

Only use the supplied lens.
Do not use other lenses. A reliable functioning of the product cannot be guaranteed with other lenses.

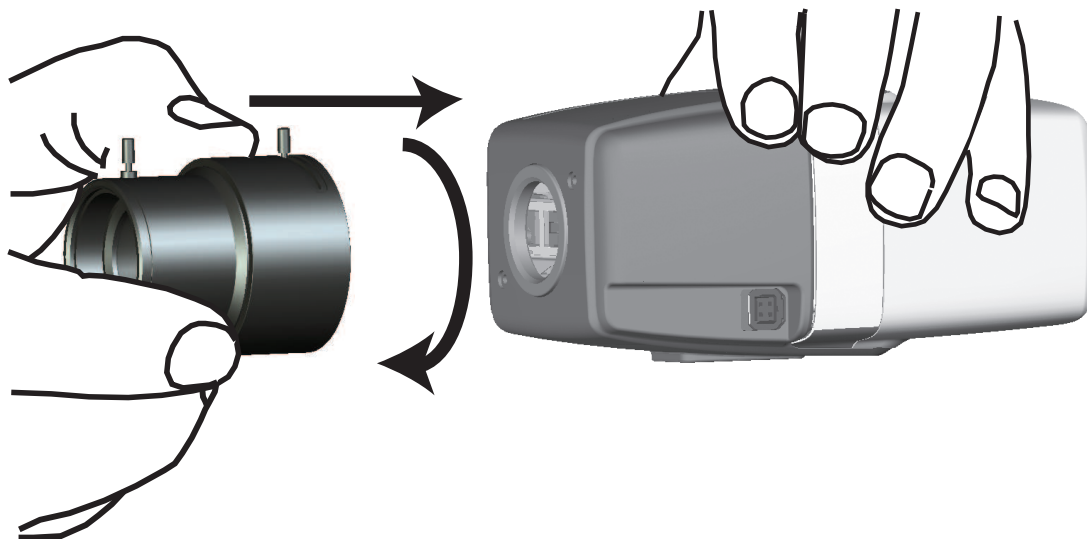

To attach the lens to the camera:

1. Remove the sensor protection cap from the camera.
2. Remove the protection cap from the lens.
3. Screw the lens onto the camera.

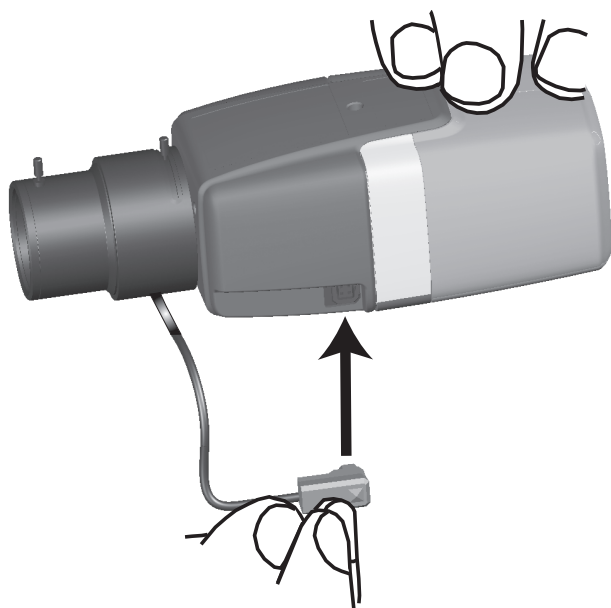

Plug the lens connector into the camera (it automatically detects the type of lens).

Pin	DC iris lens
1	Damp -
2	Damp +
3	Drive +
4	Drive -

5.2 Camera mounting

Mounting variants

Due to the provided mounting bracket, the camera can be easily mounted. There are three main mounting variants to install the camera.

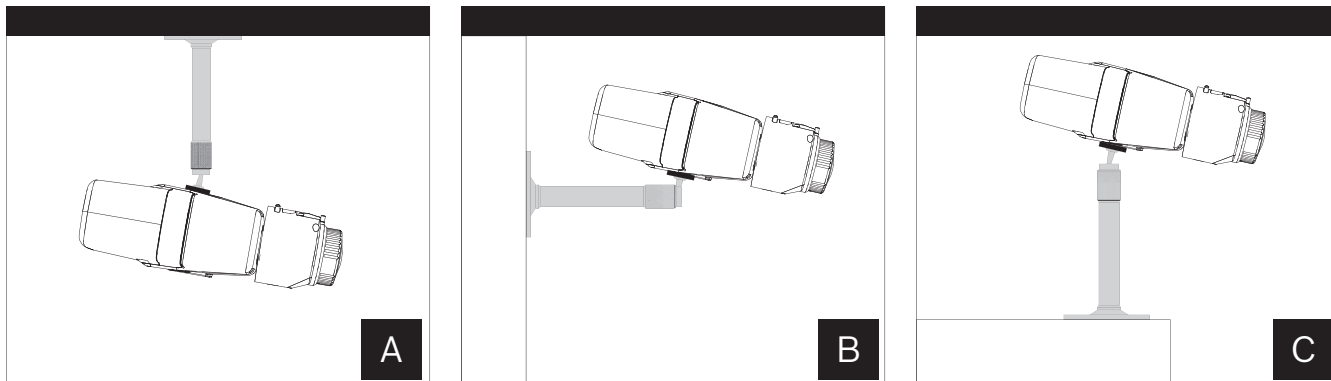

Figure 5.1: Mounting variants

A	Ceiling mount
B	Wall mount
C	Stand mount

Chose the right mounting variant for your application and mount the device according to the following options:

1. Install the mounting bracket.
2. Attach the camera to the bracket and tighten the camera lock ring.
3. Adjust the angle of the camera to set the field of view.
4. Tighten the mounting bracket lock ring to fix the camera in the desired position.

5.3 Setting the field of view

After the camera is mounted to the surface, the field of view can be set.

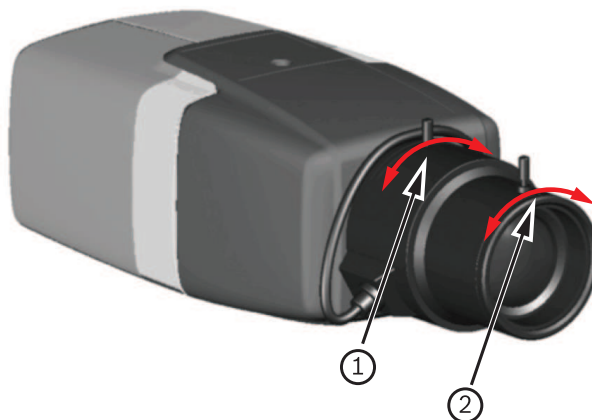

1	focal length
2	focus

The field of view must be set manually according to the following steps:

1. Manually adjust the focal length on the lens to obtain the required field of view.
2. Manually adjust the focus on the lens to obtain the sharpest image possible.

The camera lens has a motorized automatic back focus to adjust the focus at a later time via the camera menu.

5.4 Wiring of the camera

Connection to Ethernet via PoE Ethernet cable



Notice!

Use only PoE approved devices.

The camera is intended to be powered via a STP Category 5e cable in a Power-over-Ethernet (PoE) network environment . This is the default power supply.

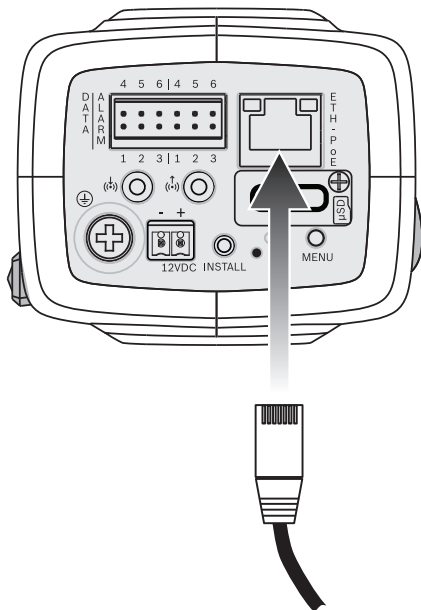

1. Connect the camera to a 10/100 Base-T network.
 2. Use STP Category 5e cable with RJ45 connectors (the camera network socket is Auto MDIX compliant).
- ✓ The LEDs beside the Ethernet connection indicate network connection (green lit) and IP traffic (orange flashing).

Auxilliary 12 V DC power supply

**Caution!**

Use **only** a +12 VDC power supply as an auxiliary power source.
The auxiliary power supply unit must be isolated from earth.

**Caution!**

The Low Voltage power supply unit must comply with EN/UL 60950. The power supply must be a SELV-LPS unit or a SELV - Class 2 unit (Safety Extra Low Voltage - Limited Power Source).





The camera can be supplied with a power supply in case of missing PoE feature of the network or for redundancy reasons.

Connect an approved power supply unit with a rated supply voltage of 12 VDC as follows:

1. Strip back 7 mm (0.28 in) of insulation on the power supply cable (must be 16-28 AWG, UL 14-30 AWG).
2. Loosen the screws of the supplied 2-pole connector and insert the stripped wires, then tighten the screws again.
3. Insert the 2-pole connector into the camera power socket.

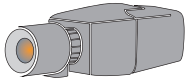
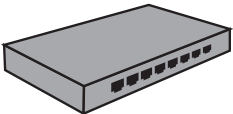
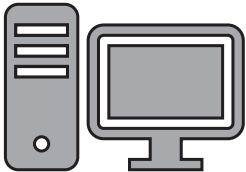
6 Camera integration

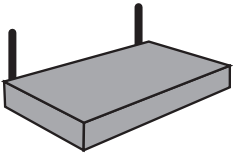
The video-based fire detection can be easily integrated into the network environment of the customer. There are several possibilities to connect the camera. Various combinations are possible. The individual customer network properties determine the performance and scalability of the system.

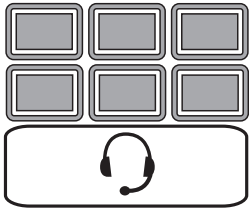
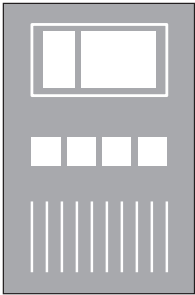
	Camera
	Network switch, PoE-ready
	Client PC
	Video Recording Manager (VRM)
	Router
	Internet
	Monitoring Center
	Fire alarm control panel

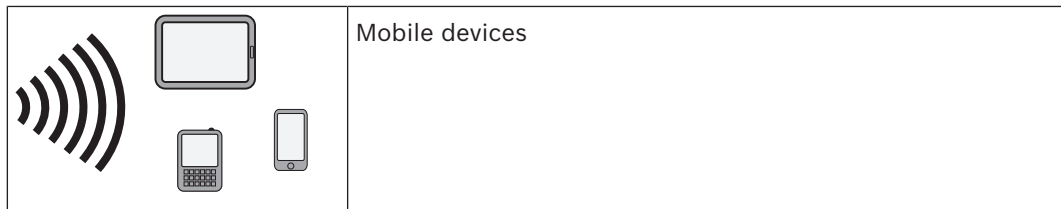

6.1 Local Area Network

Due to the IP-based camera, the integration of the video-based fire detection into the network of the customer is easy. There are a lot of opportunities regarding to scalability and enlargement of the network.

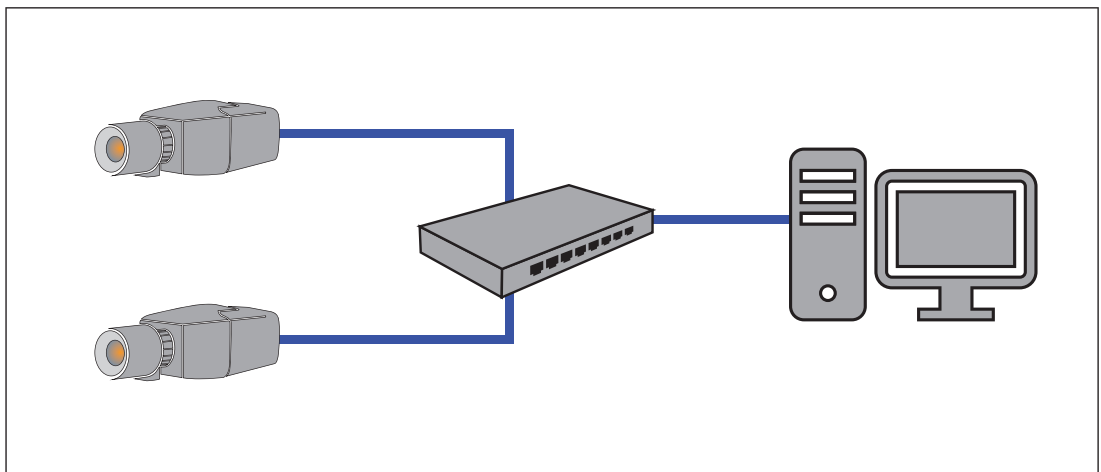

6.2 Local Area Network with recording solution

Recording and archiving functionality in the network can be realized by a video recording manager (VRM). Fire cause analysis and traceability due to legal matters are only two examples of a recording solution.

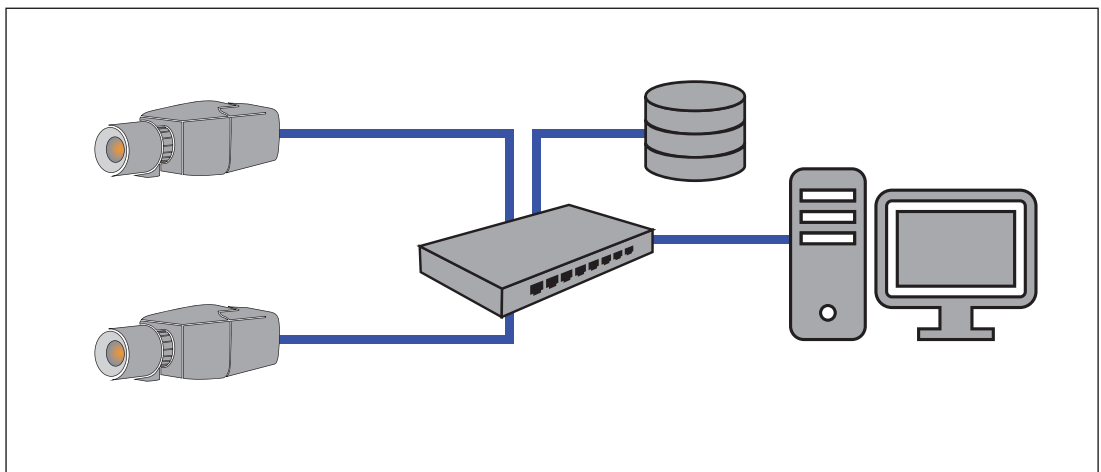

6.3 Monitoring Center

In a monitoring center, alarms can be verified to call the fire brigade and to take care of additional rescue measures.

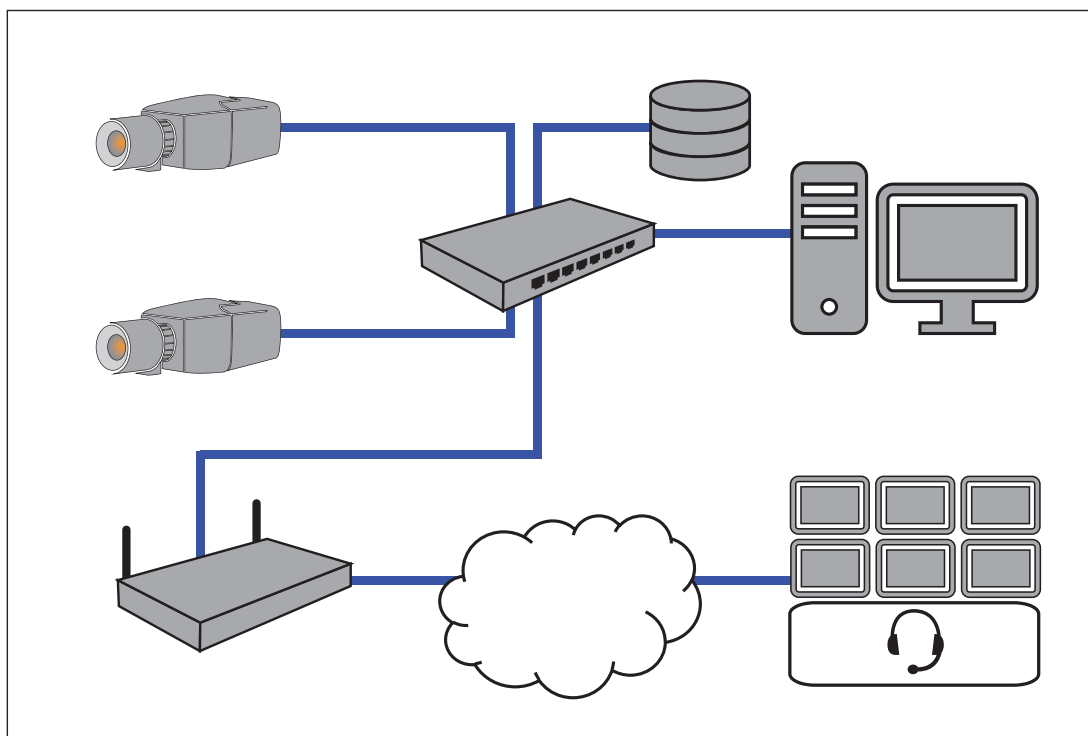

6.4 Fire Alarm Control Panel

AVIOTEC IP starlight 8000 can be connected to the a fire alarm control panel. The alarm will be triggered by the relay output of the camera.



Notice!

No direct connection to fire services in EN54 compliant installations. Authorities can allow a connection to fire services after verifying alarms in a monitoring center.



Notice!

No existing standards. There are no existing EN standards concerning the video-based fire detection.

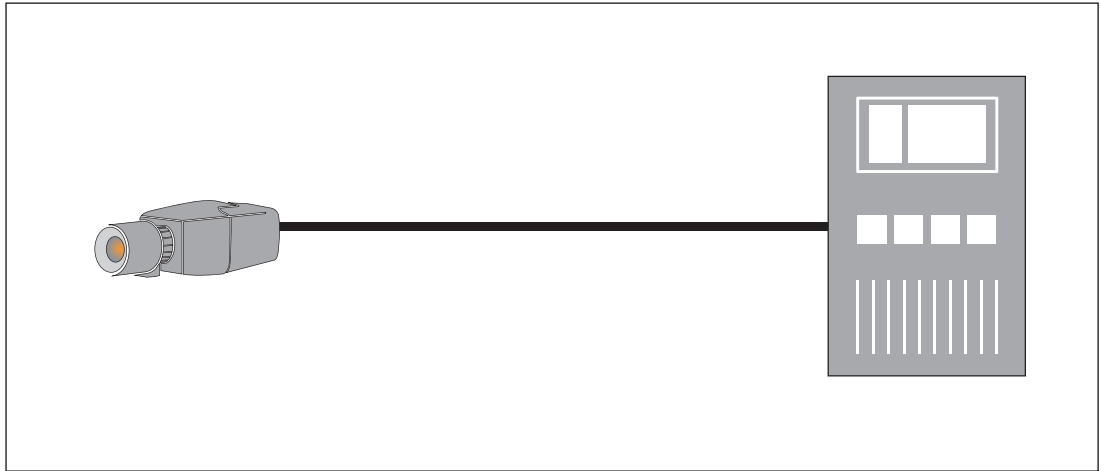

The alarm contact assignment is shown in the figure below:

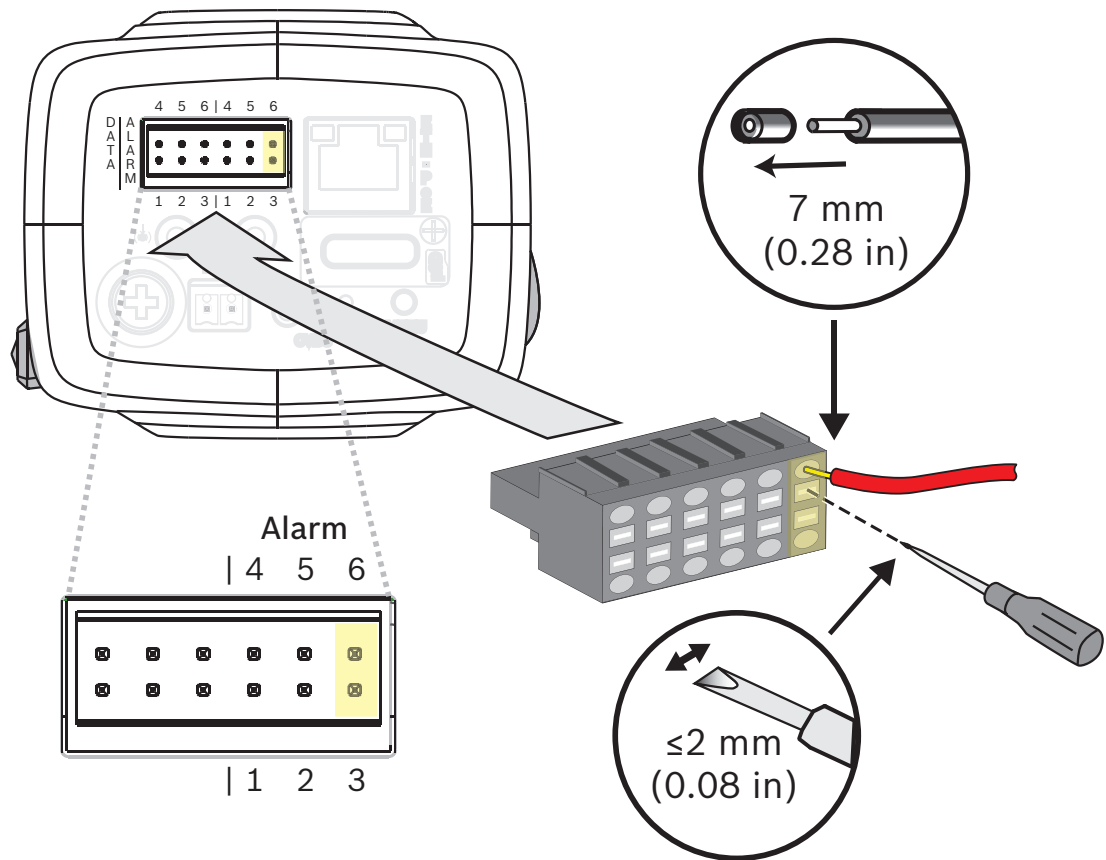

Alarm in:

Use the alarm input to connect external alarm devices such as door contacts or sensors:

- TTL logic, +5 V nominal, +40 VDC max, DC coupled with 50 kOhm pull-up to +3.3 V.
- Configurable as active low or active high.

A zero potential make-contact or switch can be used as the actuator (use a bounce-free contact system).

Pin	Alarm socket
1	Alarm in 1
4	Ground

Pin	Alarm socket
2	Alarm in 2
5	Ground

Alarm out

Use the alarm output for switching external devices such as lamps or sirens.

Alarm output switching capability:

- Max. voltage 30 VAC or +40 VDC. Max. 0.5 A continuous, 10 VA.

Pin	Alarm socket
3	Alarm out
6	

The maximum wire diameter is 18-28 AWG, UL 16-28 AWG for both stranded and solid; cut back 7 mm (0.28 in) of insulation.

Connection to a fire alarm control panel

The alarm output of the camera can be connected to a fire alarm control panel.

The camera alarm output is triggered by a relay that is normally open. In case of alarm the relay is closed.

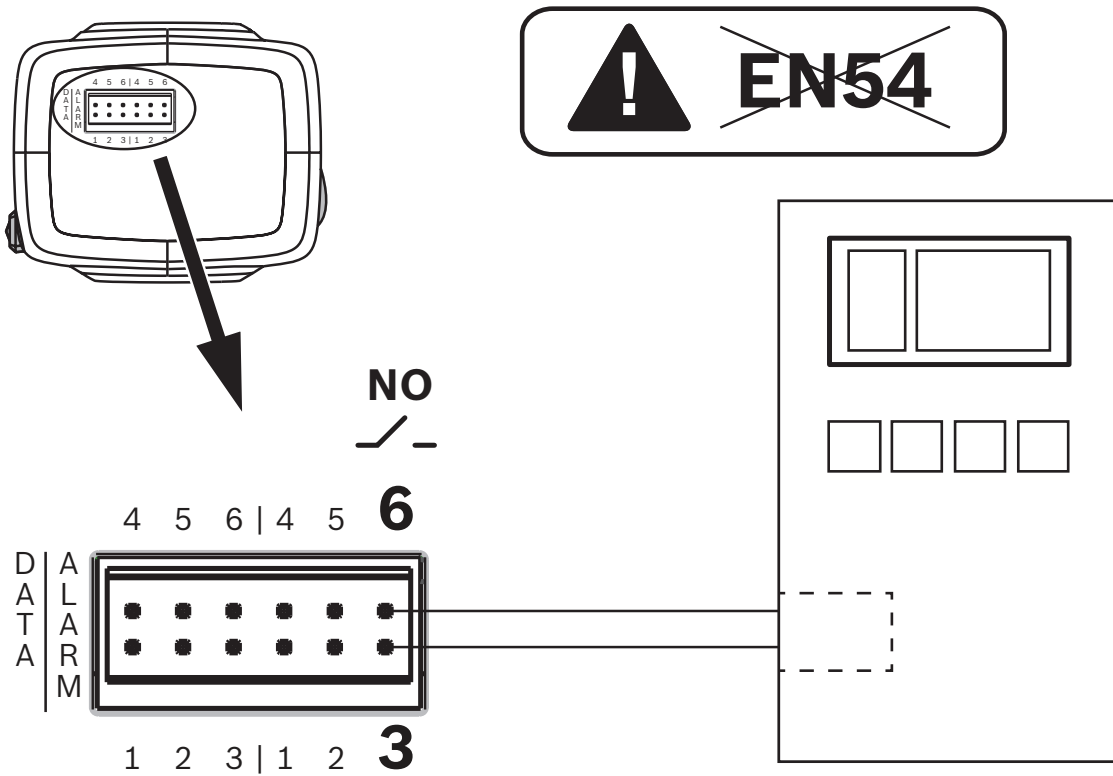

See the documentation of the individual manufacturer for further information about the connection to a fire alarm control panel.

6.5 Mobile Devices

Another advantage of the network integration of the video-based fire detection is the expandability to mobile devices, such as tablets or smartphones.

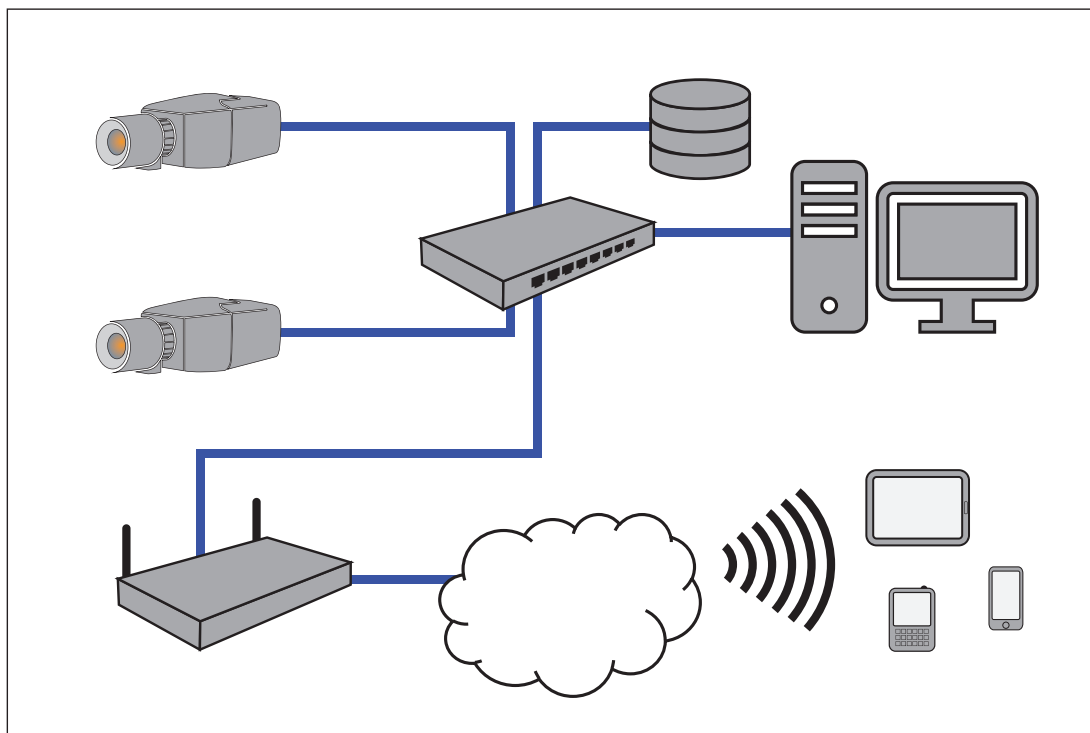

7 Access via web interface

The unit must have a valid IP address and a compatible subnet mask to operate on your network.

If the network has a DHCP server for the dynamic assignment of IP addresses, select **On** or **On plus Link-Local** to automatically accept the DHCP-assigned IP address.

If no DHCP server is available select **On plus Link-Local** to automatically assign a Link-Local (Auto-IP) address.

For certain applications, the DHCP server must support the fixed assignment between IP address and MAC address, and must be appropriately set up so that, once an IP address is assigned, it is retained each time the system is rebooted.

8 Adjustment of detection settings

The standard settings of the video-based fire detection will be sufficient for the most customer environments. Nevertheless, there are many ways to adapt the flame and smoke detection to the requirements of the customer. The detection settings of the fire detection can be changed in the configuration menu:

1. Go to **Configuration** and navigate to **Alarm**.
2. Select **Fire detection**.

General and special settings for **Fire detection** are selectable. Anytime you change the settings, confirm with **Set** to apply these changes.

If you want to abort, just click on another menu option, for example **Audio Alarm**.

The Intelligent Video Analytics functions and the video-based fire detection settings can be changed during operation and will immediately become effective.

8.1 General settings

Following settings change the detection algorithm generally.

Flames

The default setting of the flame size is 1.6% of the picture width. The **Min. size** can be set with a software slider. Possible settings are 1.1% to 2.0% of picture width. A red square at the bottom of the picture visualizes the actual setting in the original size. Small values for **Min. size** increase the distance to detectable flames, larger values decrease false alarms.

Verification time [s] of the flame detection can be set to 4, 8, 12 or 16 seconds. The default value is 8 seconds. Small values cause faster detection (higher risk of false alarms), larger values decrease false alarms.

Smoke

The default setting of the smoke size is 2.3% of the picture width. The **Min. size** can be set with a software slider. Possible settings are 1.6% to 3.1% of picture width. A yellow square at the bottom of the picture visualizes the actual setting in the original size. Small values for **Min. size** increase the distance to detectable smoke, larger values decrease false alarms.

Verification time [s] of the smoke detection can be set from 10 to 30 seconds. The default value is 15 seconds. Small values cause faster detection (higher risk of false alarms), larger values decrease false alarms.

Sensitivity

In case of false alarms, you can use a software slider to adapt the value **Sensitivity** for flame and smoke to your specific needs. The following table shows the different settings:

	Sensitivity		
	low	mid	high
Smoke	High contrast and colored objects in the video image cause false alarms. (recommendation: set also Verification time [s] to 20s)	Slow moving objects (e.g. cranes, slow vehicles, automatic doors) cause false alarms. (recommendation: set also Verification time [s] to 20s)	Default setting
Flames	If the setting mid is not sufficient to suppress blinking lights/fans or strong blinking lights with many reflections cause false alarms.	Blinking lights or fans cause false alarms. (recommendation: set also Verification time [s] to 12s)	Default setting

8.2 Adjustments of image regions



Notice!

There is no fire detection in privacy defined masks created in the Intelligent Video Analytics.

Masking

Due to the different areas of application of the camera, false alarms may be the result in individual customer environments. Algorithm disturbing elements which have an appearance similar to flames and smoke, for example ascending steam of a machine, must be excluded from the detection area.

Customized areas can be defined in the picture of the camera. These individual masks for flame and smoke detection deactivation allow individual adaption to the application of the customer. Overlapping of masks is possible.

There are several possibilities to exclude picture areas from the smoke and flame detection:

- Add masks separately for flame, smoke or both.
- Add masks with delayed smoke detection.
- Let the system automatically generate masks from the alarm memory by automasking.

Automasks support the user to adapt the system to his individual application area. Once the camera is powered, every upcoming alarm will be stored into the volatile alarm memory. Generally it is advantageous to wait a certain period of time before using the automasking feature for the first time. It depends on the special customer environment, whether there will be false alarms or not. With automasking, detection disturbing areas in the picture can automatically be masked out by the system. If there is no alarm, no automask will be generated. The user can change the size of the automasks to minimize the masked out area. The system is limited to 16 automasks (8 masks for smoke detection and 8 masks for flame detection). Changes of the flame and smoke detection settings require renewing the automasks.

Add mask

You can define individual areas in which the detection will be deactivated. These masks can easily be added to the picture area.

To add a mask, perform the following steps:

1. Click on the button **Add mask**.
A rectangle with a crossed out flame and smoke icon will appear in the middle of the picture area.
In **Properties** you can deselect **Mask flames** or **Mask smoke**.
2. Change the size and shape of the rectangle to your specific needs.
3. Move the mask to the desired area in the picture.
4. Select **Set** to confirm the changes.

Add smoke time region

Detection disturbing elements in the application of the customer, e.g. roller shutter, can be masked out. In this specific mask, the smoke detection will be delayed. This functionality is not applicable in masks with deactivated smoke detection.

To add this mask, perform the following steps:

1. Click on the button **Add smoke time region**.
A rectangle with a clock icon will appear in the middle of the picture area.
2. In **Properties** select or type in the **Verification time [s]**.
The value must be set from 5 to 120 seconds. Default value is 30 seconds.
3. Move the mask to the desired area in the picture.
4. Change shape and size to your specific needs.
5. Select **Set** to confirm the changes.

Automask



Notice!

All automasks stored in the volatile alarm memory of the camera are lost when the supply voltage is interrupted or switched off. Automasks that already have been saved will remain unaffected.



Notice!

If you change the settings of **Min. size** or **Verification time [s]**, it is necessary to renew the automasks.

1. Navigate to **Configuration > Alarm > Fire detection**.
2. Select **Automask**
The system automatically generates predefined masks from the alarm memory. The automasks are illustrated as rectangles with red dashed border.
3. Adjust the automask to your specific needs.
If it is necessary, you can add individual masks (**Add mask**).
4. Select **Set** to confirm the changes.
- ✓ Automasks were added to the system.

Reset user interface

**Notice!**

All determined masks in the user interface will be deleted! Only automasks remain stored in the alarm memory and can be regenerated.

If you want to reset the user interface to standard values:

1. Click on **Defaults**.
 2. Press **OK** to confirm.
- ✓ The system resets the user interface for fire detection to the standard settings.

Delete Automasks

**Notice!**

Delete automasks if you changed the camera position, zoom, point of view or after a fire. Also delete automasks if the spatial arrangement of objects in the detection area has changed fundamentally.

To delete the automasks for Flame detection from the alarm memory:

1. Navigate to **Fire detection > Flames > Detection**.
 2. Select **Off** and press **Set**.
 3. Select **On** and press **Set**.
- ✓ Automasks for Flame were deleted.

To delete the automasks for Smoke detection from the alarm memory:

1. Navigate to **Fire detection > Smoke > Detection**.
 2. Select **Off** and press **Set**.
 3. Select **On** and press **Set**.
- ✓ Automasks for Smoke were deleted.

8.3

Relay settings

**Notice!**

The alarm output is only configurable for flame or smoke alarms. Forwarding alarms coming from Intelligent Video Analytics is not possible.

The camera includes a built-in relay that switches in case of a flame or a smoke alarm. The relay is switched during the alarm and returns to its initial state after the alarm.

You can configure the switching behavior of the output:

Go to **Alarm > Interfaces > Alarm Outputs**

Idle state

1. Under **Idle state** select the desired initial state of the relay.
2. Select from the following options:
 - Closed:** the relay is normally closed.
 - Open:** the relay is normally open.

Output name

An individual name can be assigned to the relay. The name is shown on the button. The **Live** page can also be configured to display this individual name.

Toggle

You can click the button to switch the alarm output manually (for example, for testing purposes). A green check mark appears to indicate that the relay switches.

**Notice!**

Check carefully the toggle settings before you continue.

Press **Set** to apply the settings.

9 Troubleshooting

The following issues can be solved in the detection settings (**Configuration > Alarm > Fire detection**).

9.1 False Alarms

9.1.1 Quick solution to solve false alarms

A fast way to identify and solve region-stable false alarms in the camera image is automasking. The system automatically generates predefined masks from the alarm memory.

Navigate to **Configuration > Alarm > Fire detection**.

2. Select **Automask**.
3. Select **Set** to confirm the changes.

See also

- *Automask, page 45*

9.1.2 False alarms under 4 seconds concerning the whole detection area

In this case the general settings of the fire detection have to be adjusted.

Problem	Solution
Small bounding boxes of flame detection cause false alarms.	Increase the minimum flame size. (Flames > Min. size)
Short false alarms for smoke detection.	Increase the duration of smoke detection. (Smoke > Verification time [s])
Short false alarms for flame detection.	Increase the duration of flame detection. (Flames > Verification time [s])

9.1.3 False alarms at small constant areas

Individual image areas are affected and have to be adjusted.

Problem	Solution
Objects cause flickering motion, e.g. shadow of a flag in the wind.	Mask out the disturbing image area (for flame). <i>Flame detection will be deactivated in this mask.</i>
Continuous motion in the picture causes false alarms, e.g. escalators.	Mask out the disturbing image area (for smoke). <i>Smoke detection will be deactivated in this mask.</i>
Temporary motion causes false alarms, e.g. roller shutter.	Mask out the disturbing image area (Add smoke time region).

Smoke detection will be delayed in this mask.

9.1.4 Vibrations at the camera site

Problem	Solution
Vibrations are transferred to the camera.	Avoid vibrations at the camera site.
Camera picture is trembling.	Make sure the camera is firmly mounted.
The camera position changed because of vibrations.	Move the camera to its initial position and check the field of view. Make sure the camera is firmly mounted.

9.2 No alarm transmission

Problem: Alarms are visible in the web browser but there is no alarm transmission to the video client.

Solution:

- Check network connection and settings (**Configuration -> Network**)
- Check relay connection and settings (**Alarm > Interfaces > Alarm Outputs**)
- Check fire detection settings (**Configuration > Alarm > Fire detection**)
- Check the video client settings

9.3 No fire detection

- **Problem:** No detection of fire.
- **Solution:**
- Check fire detection settings (**Configuration > Alarm > Fire detection**)
- Check mask settings
- Check privacy mask settings
- Check the focus of the lens (**Configuration -> Camera -> Installer Menu -> Lens Wizard... ->)**
- Check obstructions in the field of view
- Check the detection area
- Check minimum/maximum distance to fire

9.4 Image quality

Interference of the camera image

Small image areas or the whole image area are affected by interferences.

Problem	Solution
Artificial light, e.g. fluorescent light, causes flickering of the camera image.	Go to Installer Menu > ALC mode and change to fluorescent mode.

9.5 Camera

If a fault cannot be resolved, please contact your supplier or system integrator, or go directly to Customer Service.

The version numbers of the internal firmware can be viewed on a service page. Please note this information before contacting Customer Service.

1. In the address bar of your browser, after the unit IP address, enter: /version
for example: 192.168.0.80/version
2. Write down the information or print out the page.

The camera offers a variety of configuration options. Therefore, check that it works properly after installation and configuration. This is the only way to ensure that the camera will function as intended in the event of an alarm.

Your check should include the following functions:

- Can you connect to the camera remotely
- Does the camera transmit all the data required?
- Does the camera respond as desired to alarm events?
- Is it possible to control peripheral devices, if necessary?

The camera has four LEDs on the rear panel:

- Two LEDs indicate the camera status (red for error; green for OK)
- Two LEDs (green and orange) beside the network connection indicate the LAN and PoE status

No OSD messages appear.	Special Video SDK is required. Video management software from third parties does not use the SDK.
-------------------------	---

The ping command can be used to check the connection between two IP addresses. This allows testing whether a device is active in the network.

1. Open the DOS command prompt.
2. Type `ping` followed by the IP address of the device.

If the device is found, the response appears as "Reply from ... ", followed by the number of bytes sent and the transmission time in milliseconds. Otherwise, the device cannot be accessed via the network. This might be because:

- The device is not properly connected to the network. Check the cable connections in this case.
- The device is not correctly integrated into the network. Check the IP address, subnet mask, and gateway address.

10 Maintenance

10.1 Cleaning

It is generally sufficient to use a dry cloth for cleaning, but a moist lint-free cloth or leather shammy may also be used.

Do not use liquid cleaners or aerosol cleaners.

It is important to keep the lens clean to ensure optimum performance. Dust, grease, or fingerprints should be removed from the lens surface. When cleaning the lens, take extra care not to damage the special coating used to reduce light reflections.

- Remove dust with a blower-brush or grease-free soft brush.
- Wipe water drops off the lens with a clean soft lint-free cloth and dry the lens surface.
- Use special lens cleaning paper or cloth treated with lens cleaning fluid to gently wipe off any remaining dirt (wipe spirally from the lens center towards the edge).

10.2 Repair



Notice!

Never open the casing of the unit

The unit does not contain any user-serviceable parts. Refer all repairs to suitable qualified specialists.

10.3 Reset

Use the factory reset button to restore the unit to its original settings. Any changes to the settings are overwritten by the factory defaults. A reset may be necessary, for example, if the unit has invalid settings that prevent it from functioning as desired.

10.4 Maintenance intervals



Notice!

Maintenance and inspection work should be carried out regularly and by trained personnel.

The following inspections are recommended:

Testing	Inspection frequency		
	annually	quarterly	regularly
Visual check of the mounting		X	
Visual check for damage		X	

Testing	Inspection frequency		
Item to inspect	annually	quarterly	regularly
Check the camera lens for pollution and damage			X
Functional check	X		
Check of the video image			X

11

Technical data

Environmental	
Operating Temperature	-20°C to +50°C (-4°F to 122°F)
Storage Temperature	-30°C to +70°C (-22°F to +158°F)
Operating Humidity	20% to 93% RH
Storage Humidity	up to 98% RH
Input/output	
Analog video out	SMB connector, CVBS (PAL/NTSC), 1 Vpp, 75 Ohm
Audio line in	1 Vrms max, 18 kOhm typical,
Audio line out	0.85 Vrms at 1.5 kOhm typical,
Audio connectors	3.5 mm mono jack
Alarm input	2 inputs
Alarm input activation	+5 VDC nominal; +40 VDC max. (DC-coupled with 50 kOhm pull-up resistor to +3.3 VDC) (< 0.5 V is low; > 1.4 V is high)
Alarm output	1 output
Alarm output voltage	30 VAC or +40 VDC max. Maximum 0.5 A continuous, 10VA (resistive load only)
Ethernet	RJ45
Data port	RS-232/422/485
Local storage	
Internal RAM	10 s pre-alarm recording
Memory card slot	Supports up to 32 GB microSDHC / 2 TB microSDXC card. (An SD card of Class 6 or higher is recommended for HD recording)
Recording	Continuous recording, ring recording, alarm/events/schedule recording
Mechanical	
Dimensions (W x H x L)	78 x 66 x140 mm (3.07 x 2.6 x 5.52 inch) without lens
Weight	855 g (1.88 lb) without lens
Color	RAL 9006 Metallic Titanium
Tripod Mount	Bottom and top 1/4-inch 20 UNC
Network	
Protocols	IPv4, IPv6, UDP, TCP, HTTP, HTTPS, RTP/RTCP, IGMP V2/V3, ICMP, ICMPv6, RTSP, FTP, ARP, DHCP, APIPA (Auto-IP, link local address), NTP (SNTP), SNMP (V1, V3, MIB-II), 802.1x,

Network	
	DNS, DNSv6, DDNS (DynDNS.org, selfHOST.de, no-ip.com), SMTP, iSCSI, UPnP (SSDP), DiffServ (QoS), LLDP, SOAP, Dropbox™, CHAP, digest authentication
Encryption	TLS 1.0, SSL, DES, 3DES
Ethernet	10/100 Base-T, auto-sensing, half/full duplex
Connectivity	ONVIF Profile S , Auto-MDIX

12

Appendices

12.1

Maximum detection distances for margin areas

Due to the optical distortion of the lens, there are deviating maximum detection distances at the margin area of the picture.

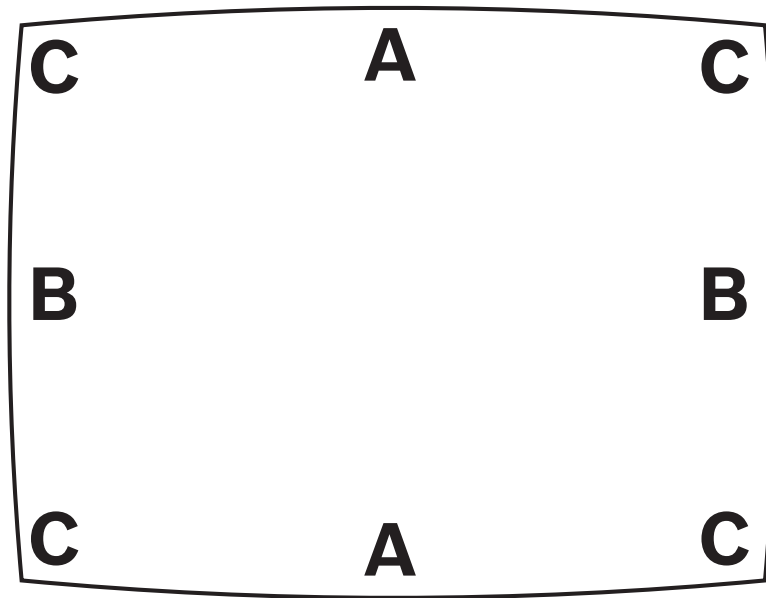

Figure 12.1: Definition of margin areas of the picture

A	Horizontal margin area
B	Vertical margin area
C	Corner area

12.1.1**Flame detection****Opening angle 100°**

Fire width (m)	A	B	C
0.3	11.01 m	7.59 m	6.19 m
0.4	14.68 m	10.12 m	8.26 m
0.5	18.34 m	12.65 m	10.32m
0.6	22.01 m	15.18 m	12.39 m
0.7	25.68 m	17.71 m	14.45 m
0.8	29.35 m	20.24 m	16.52 m
0.9	33.02 m	22.77 m	18.58 m
1	36.69 m	25.30 m	20.65 m
1.25	45.86 m	31.63 m	25.81 m
1.5	55.03 m	37.95 m	30.97 m
1.75	64.20 m	44.28 m	36.13 m
2	73.38 m	50.60 m	41.29 m
2.25	82.55 m	56.93 m	46.45 m
2.5	91.72 m	63.25 m	51.61 m
2.75	100.89 m	69.58 m	56.78 m
3	110.06 m	75.91 m	61.94 m

Opening angle 90°

Fire width (m)	A	B	C
0.3	12.29 m	9.25 m	7.91 m
0.4	16.39 m	12.34 m	10.55 m
0.5	20.49 m	15.42 m	13.19 m
0.6	24.59 m	18.51 m	15.83 m
0.7	28.68 m	21.59 m	18.46 m
0.8	32.78 m	24.68 m	21.10 m
0.9	36.88 m	27.76 m	23.74 m
1	40.98 m	30.85 m	26.38 m
1.25	51.22 m	38.56 m	32.97 m
1.5	61.46 m	46.27 m	39.57 m
1.75	71.71 m	53.98 m	46.16 m
2	81.95 m	61.69 m	52.75 m
2.25	92.20 m	69.41 m	59.35 m

2.5	102.44 m	77.12 m	65.94 m
2.75	112.68 m	84.83 m	72.54 m
3	122.93 m	92.54 m	79.13 m

Opening angle 60°

Flame width (m)	A	B	C
0.3	18.29 m	16.36 m	15.44 m
0.4	24.39 m	21.82 m	20.59 m
0.5	30.48 m	27.27 m	25.74 m
0.6	36.58 m	32.73 m	30.88 m
0.7	42.67 m	38.18 m	36.03 m
0.8	48.77 m	43.64 m	41.18 m
0.9	54.87 m	49.09 m	46.32 m
1	60.96 m	54.55 m	51.47 m
1.25	76.20 m	68.18 m	64.34 m
1.5	91.44 m	81.82 m	77.21 m
1.75	106.68 m	95.45 m	90.07 m
2	121.93 m	109.09 m	102.94 m
2.25	137.17 m	122.73 m	115.81 m
2.5	152.41 m	136.36 m	128.68 m
2.75	167.65 m	150.00 m	141.54 m
3	182.89 m	163.64 m	154.41 m

Opening angle 45°

Flame width (m)	A	B	C
0.3	24.42 m	22.91 m	22.16 m
0.4	32.57 m	30.55 m	29.54 m
0.5	40.71 m	38.19 m	36.93 m
0.6	48.85 m	45.83 m	44.32 m
0.7	56.99 m	53.46 m	51.70 m
0.8	65.13 m	61.10 m	59.09 m
0.9	73.27 m	68.74 m	66.47 m
1	81.41 m	76.38 m	73.86 m
1.25	101.77 m	95.47 m	92.33 m
1.5	122.12 m	114.57 m	110.79 m
1.75	142.47 m	133.66 m	129.26 m

2	162.83 m	152.76 m	147.72 m
2.25	183.18 m	171.85 m	166.19 m
2.5	203.53 m	190.95 m	184.65 m
2.75	223.89 m	210.04 m	203.12 m
3	244.24 m	229.13 m	221.58 m

12.1.2

Smoke detection

Opening angle 100°

Smoke width (m)	A	B	C
0.3	7.34 m	5.06 m	4.13 m
0.4	9.78 m	6.75 m	5.51 m
0.5	12.23 m	8.43 m	6.88 m
0.6	14.68 m	10.12 m	8.26 m
0.7	17.12 m	11.81 m	9.63 m
0.8	19.57 m	13.49 m	11.01 m
0.9	22.01 m	15.18 m	12.39 m
1	24.46 m	16.87 m	13.76 m
1.25	30.57 m	21.08 m	17.20 m
1.5	36.69 m	25.30 m	20.65 m
1.75	42.80 m	29.52 m	24.09 m
2	48.92 m	33.74 m	27.53 m
2.25	55.03 m	37.95 m	30.97 m
2.5	61.15 m	42.17 m	34.41 m
2.75	67.26 m	46.39 m	37.85 m
3	73.38 m	50.60 m	41.29 m

Opening angle 90°

Smoke width (m)	A	B	C
0.3	8.20 m	6.17 m	5.28 m
0.4	10.93 m	8.23 m	7.03 m
0.5	13.66 m	10.28 m	8.79 m
0.6	16.39 m	12.34 m	10.55 m
0.7	19.12 m	14.40 m	12.31 m
0.8	21.85 m	16.45 m	14.07 m
0.9	24.59 m	18.51 m	15.83 m

1	27.32 m	20.56 m	17.58 m
1.25	34.15 m	25.71 m	21.98 m
1.5	40.98 m	30.85 m	26.38 m
1.75	47.81 m	35.99 m	30.77 m
2	54.63 m	41.13 m	35.17 m
2.25	61.46 m	46.27 m	39.57 m
2.5	68.29 m	51.41 m	43.96 m
2.75	75.12 m	56.55 m	48.36 m
3	81.95 m	61.69 m	52.75 m

Opening angle 60°

Smoke width (m)	A	B	C
0.3	12.19 m	10.91 m	10.29 m
0.4	16.26 m	14.55 m	13.73 m
0.5	20.32 m	18.18 m	17.16 m
0.6	24.39 m	21.82 m	20.59 m
0.7	28.45 m	25.45 m	24.02 m
0.8	32.51 m	29.09 m	27.45 m
0.9	36.58 m	32.73 m	30.88 m
1	40.64 m	36.36 m	34.31 m
1.25	50.80 m	45.45 m	42.89 m
1.5	60.96 m	54.55 m	51.47 m
1.75	71.12 m	63.64 m	60.05 m
2	81.28 m	72.73 m	68.63 m
2.25	91.44 m	81.82 m	77.21 m
2.5	101.60 m	90.91 m	85.78 m
2.75	111.76 m	100.00 m	94.36 m
3	121.93 m	109.09 m	102.94 m

Opening angle 45°

Smoke width (m)	A	B	C
0.3	16.21 m	15.21 m	14.71 m
0.4	21.61 m	20.28 m	19.61 m
0.5	27.02 m	25.35 m	24.51 m
0.6	32.42 m	30.42 m	29.41 m
0.7	37.83 m	35.49 m	34.32 m

0.8	43.23 m	40.55 m	39.22 m
0.9	48.63 m	45.62 m	44.12 m
1	54.04 m	50.69 m	49.02 m
1.25	67.54 m	63.37 m	61.28 m
1.5	81.05 m	76.04 m	73.53 m
1.75	94.56 m	88.71 m	85.79 m
2	108.07 m	101.39 m	98.04 m
2.25	121.58 m	114.06 m	110.30 m
2.5	135.09 m	126.73 m	122.56 m
2.75	148.60 m	139.41 m	134.81 m
3	162.11 m	152.08 m	147.07 m

12.2 Commissioning report

Camera installation and configuration protocol

General	
Camera name (Configuration -> General -> Identification)	
Firmware version (Configuration -> Service -> System Overview)	
Date/Time setting (Configuration -> General -> Date/Time)	<input checked="" type="radio"/> Synchronized
Mounting height	
Field of view (Please add a screenshot)	

Screenshot location (e.g. network folder)	

Lens settings	
Lens opening angle	
ALC mode (Configuration -> Camera -> Installer Menu -> ALC mode)	
Focus Position (Configuration -> Camera -> Installer Menu -> Lens Wizard... -> Focus position)	
Focus Indicator (Configuration -> Camera -> Installer Menu -> Lens Wizard... -> Focus indicator)	
IR-corrected lens (Configuration -> Camera -> Installer Menu -> Lens Wizard... -> IR-corrected lens)	<input type="radio"/> On <input type="radio"/> Off

Network settings	
IP address (Configuration -> Network -> Network Access)	

Connection	
IP connection tested	<input type="radio"/> Yes <input type="radio"/> No
Relay connected to	
Relay tested	<input type="radio"/> Yes <input type="radio"/> No
Relay Idle state	<input type="radio"/> CLOSED <input type="radio"/> OPEN

VFD Settings	
Flame detection (Configuration -> Alarm -> Fire detection)	<input type="radio"/> On <input type="radio"/> Off
Min size	
Verification time [s]	
Smoke detection (Configuration -> Alarm -> Fire detection)	<input type="radio"/> On <input type="radio"/> Off
Min size	
Verification time [s]	
Masks (smoke, flame, smoke time region) (Please add a screenshot)	<input type="radio"/> Yes <input type="radio"/> No

<p>Privacy Masks (Please add a screenshot)</p>	<p><input type="radio"/> Yes <input type="radio"/> No</p>

Further configuration (e.g. recording, DynDNS, VCA configuration, Alarm Inputs ...):

Installation conditions / application

Scene illumination	
Check the minimum illuminance is ≥ 7 lx	<input type="radio"/> Yes <input type="radio"/> No Min. Illuminance: lx
Check the scene illumination for neon tubes LEDs and adjust the ALC mode (flickering)	<input type="radio"/> Checked ALC mode set to:
Check the illuminance in the picture. Best detection results with a maximum dynamic factor of 5 (min to max in the picture)	<input type="radio"/> Checked Darkest spot: lx Brightest spot: lx
Check camera field of view for backlights. Minimize backlights.	<input type="radio"/> No backlights <input type="radio"/> Number of backlights in the field of view: Please make smoke tests close to backlights.
24/7 illumination	<input type="radio"/> Yes <input type="radio"/> No

Field of view	
Application fully covered as discussed with the customer	<input type="radio"/> Yes <input type="radio"/> No
Minimum and maximum distances calculated and documented for the customer	<input type="radio"/> Yes <input type="radio"/> No
Obstructions in the picture taken into account	<input type="radio"/> Yes <input type="radio"/> No

Smoke test results (smoke cartridges)

Distance to smoke cartridge	
Illumination	
Smoke cartridge(s)	
Smoke detected	<input type="radio"/> Yes <input type="radio"/> No
Field of view (Please add a screenshot)	

Smoke test results (test video)

Distance to monitor	
Illumination	
Smoke detected	<input type="radio"/> Yes <input type="radio"/> No
Field of view (Please add a screenshot)	

Flame test results (test video)

Distance to monitor	
Illumination	
Flame detected	<input type="radio"/> Yes <input type="radio"/> No
Field of view (Please add a screenshot)	

Smoke/flame test results (test video)

Distance to monitor	
Illumination	
Smoke detected	<input type="radio"/> Yes <input type="radio"/> No
Flame detected	<input type="radio"/> Yes <input type="radio"/> No
Field of view (Please add a screenshot)	

Place:	Issuer:
Date:	Signature:

Index

A

ALC mode	49
algorithm	14
automask	45
automask	45
delete automasks	46

B

backlight	28
-----------	----

F

field of view	9
flame	
Min. Size	43
Verification time [s]	43
flickering	49
focal length	9

I

Illumination	8, 28
--------------	-------

M

masking	
add mask	45
add smoke time region	45
introduction	44
monitoring area	9, 10

P

privacy mask	28
--------------	----

R

relay	46
-------	----

S

smoke	
Min. size	43
Verification time [s]	43

T

troubleshooting	48
-----------------	----

V

Video Management System	19
-------------------------	----



Bosch Sicherheitssysteme GmbH

Robert-Bosch-Ring 5

85630 Grasbrunn

Germany

www.boschsecurity.com

© Bosch Sicherheitssysteme GmbH, 2018