

LSTAT-800, LSTAT-801, LSTAT-802

Datasheet #89034320



The L-STAT is a room operator panel device with a modern, minimalistic look that fits any interior design. It is directly connected to a LOYTEC controller with a Modbus interface such as LIOB-AIR or L-ROC.

Up to 16 L-STAT devices can be connected to one controller to offer control at different locations in- or outside even for the largest rooms. The L-STAT is equipped with a segmented LCD display featuring an RGB backlight with adjustable color, offering a neat way to make the L-STAT match the interior color concept of an office building. Eight capacitive touch buttons are used to cycle through sensor values, display parameters, and adjust setpoints. Up to four external buttons can be accessed and processed by the controller.

The L-STAT's internal sensors measure temperature, humidity, dew point, occupancy, and CO₂ level. Sensor values can be displayed in SI or US units. Additionally, the date and time as well as the current level of eco-friendliness in the form of green leaves are also displayed on the LCD display. Parameters controlled by the controller's logic can be overridden on the L-STAT, such as for occupancy, air conditioning, and ventilation. A direct access mode is available to quickly adjust the most important setpoints e.g. for temperature and ventilation control.

A buzzer provides acoustic feedback for the touch buttons and can also be used to indicate alarms and error states. To prevent unauthorized modifications, two access levels (end user, system integrator) are used, which are secured via 4-digit pin codes. Device replacement, firmware upgrade, and L-STAT configuration are performed with very little effort through the controller. The L-STAT device is represented in the controller by a simple data point interface, which can be directly connected to the IEC 61131 or IEC 61499 logic application and offers all common functions for data points such as alarming, scheduling, trending, historic filters, math functions, etc.

Using an NFC tag, the L-STAT transmits the URL of the controller's web interface to mobile devices for more extensive control and administrative tasks. Last but not least, the L-STAT comes with a built-in infrared receiver for comfortable remote control of the room's lights, sunblinds and HVAC system via the optionally available IR remote control L-RC1.

The L-STAT is available in three different hardware versions, with six different button layouts, and two front cover color options (36 models in total). Furthermore, custom versions tailored to the clients requirements can be ordered (minimum quantity 100 pieces). In this case, custom printing on the front of the L-STAT allows for any button layout, individual button symbols and even catering the end customer's corporate identity.

LSTAT-80x-CUSTOM



L-STAT Room Operator Panel

LSTAT-800, LSTAT-801, LSTAT-802

Custom versions of the L-STAT are available with all three different hardware versions. Additionally, they can be equipped with an EnOcean interface. In this case, the L-STAT acts as a remote EnOcean transceiver for all controllers supporting an L-STAT interface.

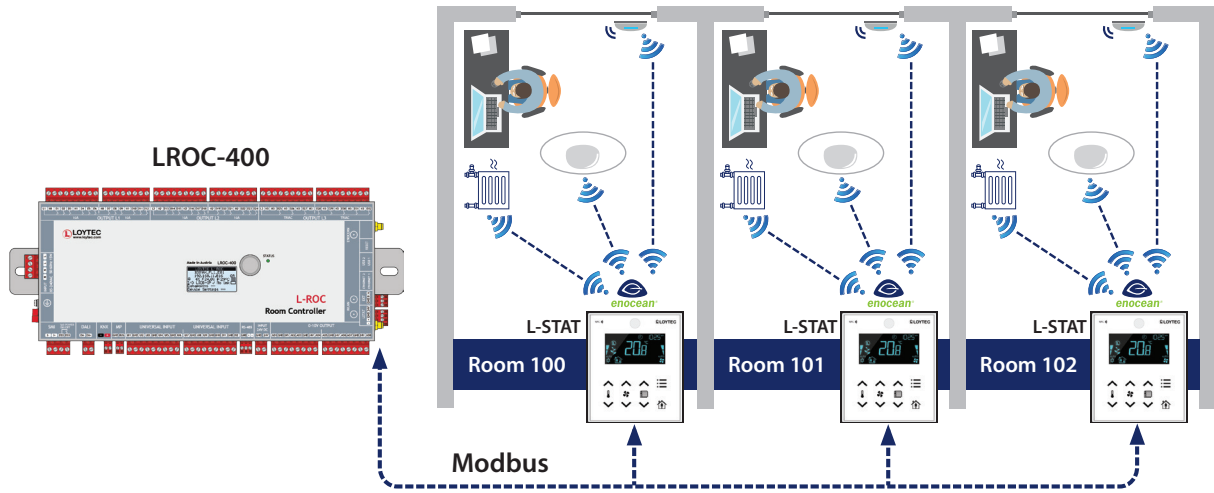

Features

- Modbus RTU interface for integration into controllers
- Easy integration into LOYTEC controllers such as L-INX, L-ROC or LIOB-AIR
- Segmented LCD display
- LCD RGB backlight color can be adjusted via network
- Display time and date
- Symbols for eco-friendliness level (green leaves)
- Up to 8 buttons (capacitive touch)
- Temperature sensor
- Humidity sensor
- 3 digital inputs (dry contact)
- 1 universal input (digital/NTC10k)
- NFC (Near Field Communication) with content configurable via network
- Buzzer to provide acoustic feedback for the touch buttons or to indicate alarms
- Two access levels (end user, system integrator), which are secured via 4-digit pin codes
- Enclosure color options black and white
- Individual layout of touch symbols on request to match room functions
- Individual front cover printing on request to match clients room design or corporate identity
- Optional occupancy sensor (LSTAT-801 and LSTAT-802 models only)
- Optional CO₂ sensor (LSTAT-802 models only)
- Optional EnOcean interface (custom models only) to work as remote EnOcean transceiver for LOYTEC controllers

Specifications

| Type | LSTAT-800-Gx-Lxxx | LSTAT-801-Gx-Lxxx | LSTAT-802-Gx-Lxxx |
|----------------------------|---------------------------------------------------------------------------------------------------------------------------------------------------------------------------------------------------------------------------------------------------------------------------------------------------------------------------------------------------------------------------------------------------------------------------------------------------------------------------------------------------------------------------------------------------------------------------------------------------------------------------------------------------------------------------------------------------------|----------------------|-------------------------------|
| Dimensions (mm) | 94.5 x 110 x 19.5 (W x H x D), DIM032 | | |
| Installation | Onto a flush-mounted box | | |
| Power supply | 24 VDC \pm 10 %, max. 0.8 W | | 24 VDC \pm 10 %, max. 1.8 W |
| Operating conditions | 0 °C to 50 °C, 10 – 90 % RH, noncondensing, degree of protection: IP30 | | |
| Display | LCD display featuring an RGB backlight with adjustable color | | |
| Interfaces, sensors | 1 x RS-485 (ANSI TIA/EIA-485): Modbus RTU (Slave), adjustable bus speed 1 200 – 115 200 bit/s (typical 57 600 bit/s), configurable transmission mode (typical "8E1", 1 start bit, 8 data bits, even parity, 1 stop bit) 1 x NFC (Near Field Communication) 1 x Buzzer 1 x Internal temperature sensor 1 x Internal relative humidity sensor 3 x Digital Input for connection of standard switches and pushbuttons 1 x Universal Input, configurable either for L-TEMP2 (NTC temperature sensor) or for connection of standard switches and pushbuttons 1 x Infrared receiver 1 x EnOcean Wireless Interface conforming to ISO/IEC 14543-3-10 (optional for LSTAT-80x-CUSTOM) | | |
| | | 1 x Occupancy sensor | |
| | | | 1 x CO ₂ sensor |
| Buttons (capacitive touch) | LSTAT-80x-Gx-Lxx1: 4 x Button with temperature up/down, occupancy, and menu LSTAT-80x-Gx-Lxx2: 6 x Button with temperature up/down, fan up/down, occupancy, and menu LSTAT-80x-Gx-Lxx3: 8 x Button with temperature up/down, fan up/down, light on/off, occupancy, and menu LSTAT-80x-Gx-Lxx4: 8 x Button with temperature up/down, sunblinds up/down, light on/off, occupancy, and menu LSTAT-80x-Gx-Lxx5: 8 x Button with temperature up/down, fan up/down, sunblinds up/down, occupancy, and menu LSTAT-80x-Gx-Lxx6: 8 x Button with temperature up/down, fan up/down, sunblinds up/down, light, and menu | | |
| For use with | L-INX, L-ROC, L-GATE, LIOB-AIR Controller, Third party controller with Modbus Master via Modbus RTU | | |

Specifications of the sensors

| | |
|------------------------------------------------------|---------------------------------------------------------------------------------------------------------------------------------------------------------------------------------------------------------------------|
| Temperature measurement | Sensor type: CMOS, range: -40 – 125 °C, resolution: 0.1 °C, accuracy: \pm 0.5 °C (5 – 60 °C) |
| Relative Humidity (R.H.) | Sensor type: capacitive humidity sensor, range: 0% – 100% R.H., resolution: 0.1% R.H., accuracy: \pm 2% R.H. @ 25 °C, 20% – 80% R.H. \pm 3% R.H. @ 25 °C, 0% – 20% R.H. and 80% – 100% R.H., respectively |
| Infrared occupancy detector, maximum detection range | 5 m, 64 zones, opening angle horizontal: 94°, vertical: 82°, difference in temperature: target to environment: > 4 °C |
| CO ₂ | 0 – 2 000 ppm, \pm 30 ppm or \pm 3% |
| Infrared receiver | NEC protocol (Apple Remote compatible) |

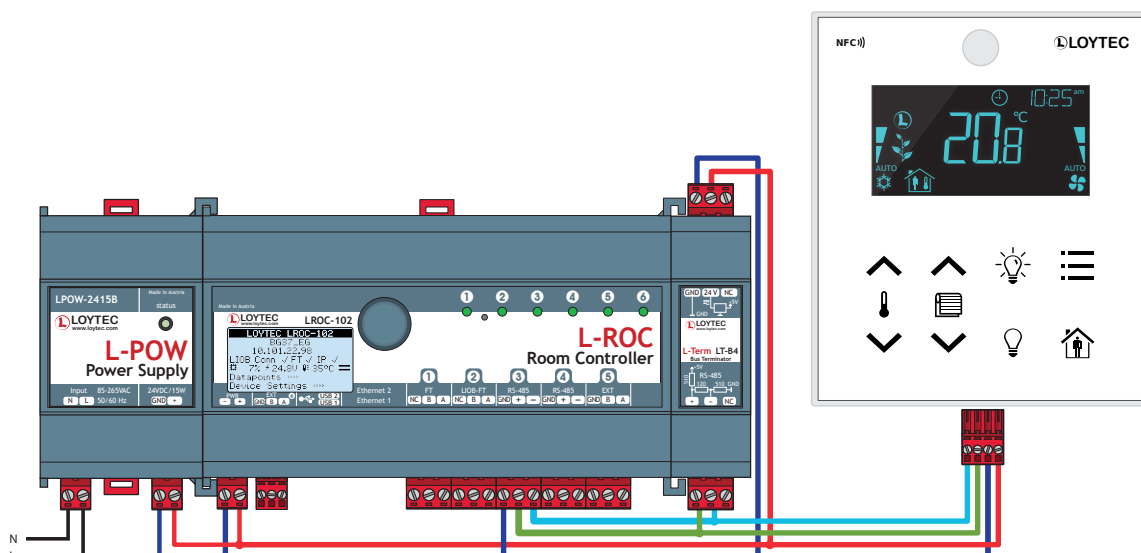

L-STAT Room Operator Panel

LSTAT-800, LSTAT-801, LSTAT-802

L-STAT Button Configuration Overview

L-STAT-80x-G3-L1



L-STAT-80x-G3-L2



L-STAT-80x-G3-L3



L-STAT-80x-G3-L4



L-STAT-80x-G3-L5



L-STAT-80x-G3-L6



L-STAT-80x-G3-L201

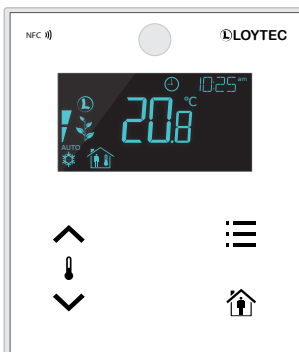

L-STAT-80x-G3-L202

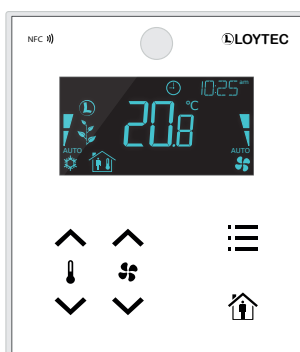

L-STAT-80x-G3-L203

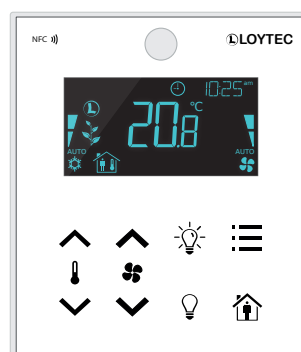

L-STAT-80x-G3-L204



L-STAT-80x-G3-L205



L-STAT-80x-G3-L206

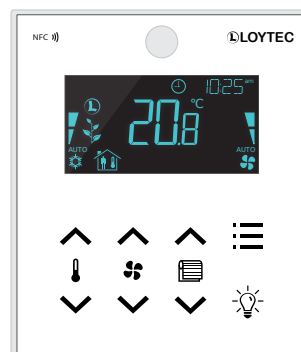

LSTAT-800, LSTAT-801, LSTAT-802

| Order number | Product description |
|------------------|---------------------------------------------------------------------------------------------------------------------------------------------------------------------------------------------------------------------------|
| LSTAT-800-G3-L1 | Room Operator Panel, black front, white enclosure, Modbus, NFC, temperature, rel. humidity, ext. switch/NTC, IR receiver, Buttons (L1): temperature up_down/occupancy/menu |
| LSTAT-800-G3-L2 | Room Operator Panel, black front, white enclosure, Modbus, NFC, temperature, rel. humidity, ext. switch/NTC, IR receiver, Buttons (L2): temperature up_down/fan up_down/occupancy/menu |
| LSTAT-800-G3-L3 | Room Operator Panel, black front, white enclosure, Modbus, NFC, temperature, rel. humidity, ext. switch/NTC, IR receiver, Buttons (L3): temperature up_down/fan up_down/light on_off/occupancy/menu |
| LSTAT-800-G3-L4 | Room Operator Panel, black front, white enclosure, Modbus, NFC, temperature, rel. humidity, ext. switch/NTC, IR receiver, Buttons (L4): temperature up_down/sunblinds up_down/light on_off/occupancy/menu |
| LSTAT-800-G3-L5 | Room Operator Panel, black front, white enclosure, Modbus, NFC, temperature, rel. humidity, ext. switch/NTC, IR receiver, Buttons (L5): temperature up_down/fan up_down/sunblinds up_down/occupancy/menu |
| LSTAT-800-G3-L6 | Room Operator Panel, black front, white enclosure, Modbus, NFC, temperature, rel. humidity, ext. switch/NTC, IR receiver, Buttons (L6): temperature up_down/fan up_down/sunblinds up_down/light/menu |
| LSTAT-801-G3-L1 | Room Operator Panel, front black, white enclosure, Modbus, NFC, temperature, rel. humidity, ext. switch/NTC, occupancy, IR receiver, Buttons (L1): temperature up_down/occupancy/menu |
| LSTAT-801-G3-L2 | Room Operator Panel, front black, white enclosure, Modbus, NFC, temperature, rel. humidity, ext. switch/NTC, occupancy, IR receiver, Buttons (L2): temperature up_down/fan up_down/occupancy/menu |
| LSTAT-801-G3-L3 | Room Operator Panel, front black, white enclosure, Modbus, NFC, temperature, rel. humidity, ext. switch/NTC, occupancy, IR receiver, Buttons (L3): temperature up_down/fan up_down/light on_off/occupancy/menu |
| LSTAT-801-G3-L4 | Room Operator Panel, front black, white enclosure, Modbus, NFC, temperature, rel. humidity, ext. switch/NTC, occupancy, IR receiver, Buttons (L4): temperature up_down/sunblinds up_down/light on_off/occupancy/menu |
| LSTAT-801-G3-L5 | Room Operator Panel, front black, white enclosure, Modbus, NFC, temperature, rel. humidity, ext. switch/NTC, occupancy, IR receiver, Buttons (L5): temperature up_down/fan up_down/sunblinds up_down/occupancy/menu |
| LSTAT-801-G3-L6 | Room Operator Panel, front black, white enclosure, Modbus, NFC, temperature, rel. humidity, ext. switch/NTC, occupancy, IR receiver, Buttons (L6): temperature up_down/fan up_down/sunblinds up_down/light/menu |
| LSTAT-802-G3-L1 | Room Operator Panel, front black, white enclosure, Modbus, NFC, temperature, rel. humidity, ext. switch/NTC, occupancy, IR receiver, CO2, Buttons (L1): temperature up_down/occupancy/menu |
| LSTAT-802-G3-L2 | Room Operator Panel, front black, white enclosure, Modbus, NFC, temperature, rel. humidity, ext. switch/NTC, occupancy, IR receiver, CO2, Buttons (L2): temperature up_down/fan up_down/occupancy/menu |
| LSTAT-802-G3-L3 | Room Operator Panel, front black, white enclosure, Modbus, NFC, temperature, rel. humidity, ext. switch/NTC, occupancy, IR receiver, CO2, Buttons (L3): temperature up_down/fan up_down/light on_off/occupancy/menu |
| LSTAT-802-G3-L4 | Room Operator Panel, front black, white enclosure, Modbus, NFC, temperature, rel. humidity, ext. switch/NTC, occupancy, IR receiver, CO2, Buttons (L4): temperature up_down/sunblinds up_down/light on_off/occupancy/menu |
| LSTAT-802-G3-L5 | Room Operator Panel, front black, white enclosure, Modbus, NFC, temperature, rel. humidity, ext. switch/NTC, occupancy, IR receiver, CO2, Buttons (L5): temperature up_down/fan up_down/sunblinds up_down/occupancy/menu |
| LSTAT-802-G3-L6 | Room Operator Panel, front black, white enclosure, Modbus, NFC, temperature, rel. humidity, ext. switch/NTC, occupancy, IR receiver, CO2, Buttons (L6): temperature up_down/fan up_down/sunblinds up_down/light/menu |
| LSTAT-80x-CUSTOM | Customized Room Operator Panel, minimum quantity 100 pieces, enclosure G1: silver, G2: black, G3: white; custom print Lx, EnOcean optional, including 2 working samples, typical lead time 10 weeks |
| L-RC1 | Infrared remote control for room automation applications |

A complete list of L-STAT models is available on our website www.loytec.com/lstat.

L-STAT Room Operator Panel

LSTAT-800, LSTAT-801, LSTAT-802

| Order number | Product description |
|-------------------|---------------------------------------------------------------------------------------------------------------------------------------------------------------------------------------------------------------------------|
| LSTAT-800-G3-L201 | Room Operator Panel, white front, white enclosure, Modbus, NFC, temperature, rel. humidity, ext. switch/NTC, IR receiver, Buttons (L1): temperature up_down/occupancy/menu |
| LSTAT-800-G3-L202 | Room Operator Panel, white front, white enclosure, Modbus, NFC, temperature, rel. humidity, ext. switch/NTC, IR receiver, Buttons (L2): temperature up_down/fan up_down/occupancy/menu |
| LSTAT-800-G3-L203 | Room Operator Panel, white front, white enclosure, Modbus, NFC, temperature, rel. humidity, ext. switch/NTC, IR receiver, Buttons (L3): temperature up_down/fan up_down/light on_off/occupancy/menu |
| LSTAT-800-G3-L204 | Room Operator Panel, white front, white enclosure, Modbus, NFC, temperature, rel. humidity, ext. switch/NTC, IR receiver, Buttons (L4): temperature up_down/sunblinds up_down/light on_off/occupancy/menu |
| LSTAT-800-G3-L205 | Room Operator Panel, white front, white enclosure, Modbus, NFC, temperature, rel. humidity, ext. switch/NTC, IR receiver, Buttons (L5): temperature up_down/fan up_down/sunblinds up_down/occupancy/menu |
| LSTAT-800-G3-L206 | Room Operator Panel, white front, white enclosure, Modbus, NFC, temperature, rel. humidity, ext. switch/NTC, IR receiver, Buttons (L6): temperature up_down/fan up_down/sunblinds up_down/light/menu |
| LSTAT-801-G3-L201 | Room Operator Panel, white front, white enclosure, Modbus, NFC, temperature, rel. humidity, ext. switch/NTC, occupancy, IR receiver, Buttons (L1): temperature up_down/occupancy/menu |
| LSTAT-801-G3-L202 | Room Operator Panel, white front, white enclosure, Modbus, NFC, temperature, rel. humidity, ext. switch/NTC, occupancy, IR receiver, Buttons (L2): temperature up_down/fan up_down/occupancy/menu |
| LSTAT-801-G3-L203 | Room Operator Panel, white front, white enclosure, Modbus, NFC, temperature, rel. humidity, ext. switch/NTC, occupancy, IR receiver, Buttons (L3): temperature up_down/fan up_down/light on_off/occupancy/menu |
| LSTAT-801-G3-L204 | Room Operator Panel, white front, white enclosure, Modbus, NFC, temperature, rel. humidity, ext. switch/NTC, occupancy, IR receiver, Buttons (L4): temperature up_down/sunblinds up_down/light on_off/occupancy/menu |
| LSTAT-801-G3-L205 | Room Operator Panel, white front, white enclosure, Modbus, NFC, temperature, rel. humidity, ext. switch/NTC, occupancy, IR receiver, Buttons (L5): temperature up_down/fan up_down/sunblinds up_down/occupancy/menu |
| LSTAT-801-G3-L206 | Room Operator Panel, white front, white enclosure, Modbus, NFC, temperature, rel. humidity, ext. switch/NTC, occupancy, IR receiver, Buttons (L6): temperature up_down/fan up_down/sunblinds up_down/light/menu |
| LSTAT-802-G3-L201 | Room Operator Panel, white front, white enclosure, Modbus, NFC, temperature, rel. humidity, ext. switch/NTC, occupancy, IR receiver, CO2, Buttons (L1): temperature up_down/occupancy/menu |
| LSTAT-802-G3-L202 | Room Operator Panel, white front, white enclosure, Modbus, NFC, temperature, rel. humidity, ext. switch/NTC, occupancy, IR receiver, CO2, Buttons (L2): temperature up_down/fan up_down/occupancy/menu |
| LSTAT-802-G3-L203 | Room Operator Panel, white front, white enclosure, Modbus, NFC, temperature, rel. humidity, ext. switch/NTC, occupancy, IR receiver, CO2, Buttons (L3): temperature up_down/fan up_down/light on_off/occupancy/menu |
| LSTAT-802-G3-L204 | Room Operator Panel, white front, white enclosure, Modbus, NFC, temperature, rel. humidity, ext. switch/NTC, occupancy, IR receiver, CO2, Buttons (L4): temperature up_down/sunblinds up_down/light on_off/occupancy/menu |
| LSTAT-802-G3-L205 | Room Operator Panel, white front, white enclosure, Modbus, NFC, temperature, rel. humidity, ext. switch/NTC, occupancy, IR receiver, CO2, Buttons (L5): temperature up_down/fan up_down/sunblinds up_down/occupancy/menu |
| LSTAT-802-G3-L206 | Room Operator Panel, white front, white enclosure, Modbus, NFC, temperature, rel. humidity, ext. switch/NTC, occupancy, IR receiver, CO2, Buttons (L6): temperature up_down/fan up_down/sunblinds up_down/light/menu |
| LSTAT-80x-CUSTOM | Customized Room Operator Panel, minimum quantity 100 pieces, enclosure G1: silver, G2: black, G3: white; custom print Lx, EnOcean optional, including 2 working samples, typical lead time 10 weeks |
| L-RC1 | Infrared remote control for room automation applications |

A complete list of L-STAT models is available on our website www.loytec.com/lstat.

Dimensions of the devices in mm and [inch]

DIM032 LSTAT-800-Gx-Lx
LSTAT-801-Gx-Lx
LSTAT-802-Gx-Lx

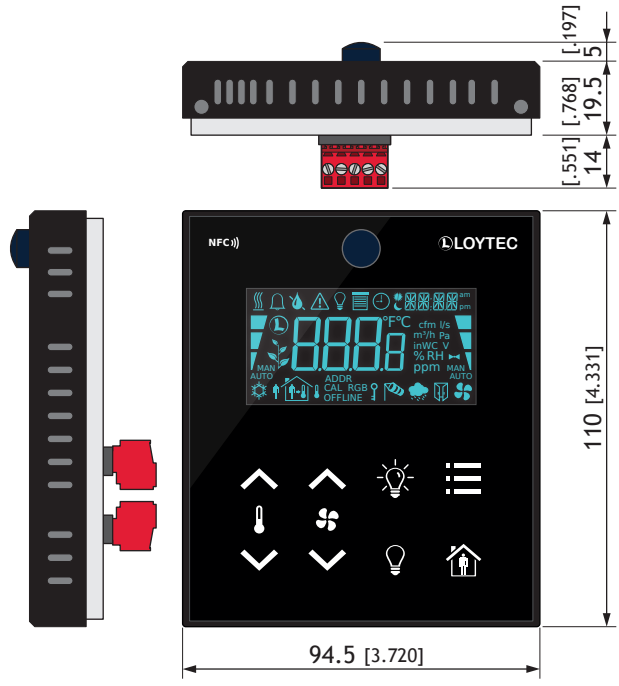

DIM033 LSMI-800

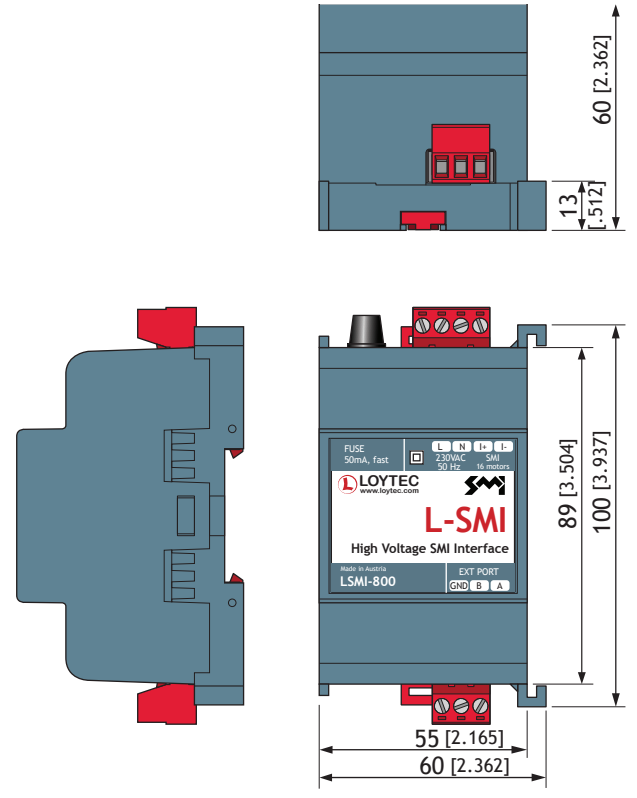

DIM034 LSMI-804

