L-DALI™

DALI Light Controller

User Manual

LOYTEC electronics GmbH



Contact

LOYTEC
Blumengasse 35
A-1170 Vienna
AUSTRIA/EUROPE
support@loytec.com
<http://www.loytec.com>

Version 6.4

Document 88077114

LOYTEC MAKES AND YOU RECEIVE NO WARRANTIES OR CONDITIONS,
EXPRESS, IMPLIED, STATUTORY OR IN ANY COMMUNICATION WITH YOU,
AND

LOYTEC SPECIFICALLY DISCLAIMS ANY IMPLIED WARRANTY OF
MERCHANTABILITY OR FITNESS FOR A PARTICULAR PURPOSE. THIS
PRODUCT IS NOT DESIGNED OR INTENDED FOR USE IN EQUIPMENT
INTENDED FOR SURGICAL IMPLANT INTO THE BODY OR OTHER
APPLICATIONS INTENDED TO SUPPORT OR SUSTAIN LIFE, FOR USE IN FLIGHT
CONTROL OR ENGINE CONTROL EQUIPMENT WITHIN AN AIRCRAFT, OR FOR
ANY OTHER APPLICATION IN WHICH IN THE FAILURE OF SUCH PRODUCT
COULD CREATE A SITUATION IN WHICH PERSONAL INJURY OR DEATH MAY
OCCUR. LOYTEC MAKES NO REPRESENTATION AND OFFERS NO WARRANTY
OF ANY KIND REGARDING OF ANY THIRDPARTY COMPONENTS MENTIONED
IN THIS MANUAL.

No part of this publication may be reproduced, stored in a retrieval system, or transmitted,
in any form or by any means, electronic, mechanical, photocopying, recording, or
otherwise, without the prior written permission of LOYTEC.

LC3020™, L-Chip™, L-Core™, L-DALI™, L-GATE™, L-INX™, L-IOB™,
LIOB-Connect™, LIOB-FT™, L-IP™, LPA™, L-Proxy™, L-Switch™, L-Term™,
L-VIS™, L-WEB™, L-ZIBI™, ORION™ stack and Smart Auto-Connect™ are
trademarks of LOYTEC electronics GmbH.

LonTalk®, LONWORKS®, Neuron®, LONMARK®, LonMaker®, *i.LON*®, and LNS® are
trademarks of Echelon Corporation registered in the United States and other countries.

Contents

1	Introduction	9
1.1	Overview	9
1.2	L-DALI Models	13
1.3	Scope.....	14
2	What's New in L-DALI.....	15
2.1	New in L-DALI 6.4.....	15
2.2	New in L-DALI 6.3.....	18
2.3	New in L-DALI 6.1.....	21
2.4	New in L-DALI 6.0.....	24
2.5	New in L-DALI 5.3.....	26
2.6	New in L-DALI 5.2.....	26
2.7	New in L-DALI 3.2.....	29
3	Quick-Start Guide	32
3.1	Hardware Installation.....	32
3.1.1	Models without built-in DALI Bus Power Supply.....	32
3.1.2	Models with built-in DALI Bus Power Supply.....	33
3.2	Test proper wiring of DALI devices	34
3.2.1	Models without LCD display.....	34
3.2.2	Models with LCD display	34
3.3	Device configuration	35
3.4	Configuration of IP Address	35
3.4.1	IP Configuration via the LCD Display.....	35
3.4.2	IP Configuration via the Web Interface	36
3.4.3	IP Configuration via Console.....	38
3.5	Configuration with PC Software.....	39
3.5.1	Connect to Device in Stand-Alone Mode	40
3.5.2	Scan DALI Channel.....	40
3.5.3	Assign Lamps, Sensor and Button to LONMARK/BACnet Objects.....	41
3.5.4	Grouping Lamps	42
3.5.5	Parameterize the Constant Light Controller.....	42
3.5.6	Parameterize the DALI button	43
3.5.7	Download Configuration	44
3.5.8	Calibrate Light Sensor	45
3.6	Configuration using Web Interface	46
3.6.1	Scan DALI Channel.....	46
3.6.2	Assign Lamps, Sensor and Button to LONMARK/BACnet Objects.....	48

3.6.3	Grouping Lamps.....	48
3.6.4	Calibrate Light Sensor.....	49
3.6.5	Parameterize the DALI button.....	50
3.6.6	Parameterize the Constant Light Controller	50
3.7	Configuration of BACnet Interface (LDALI-20X only)	52
3.7.1	Configure BACnet Interface.....	52
4	Hardware Installation.....	53
4.1	Enclosure.....	53
4.1.1	LDALI-3E10X-U and LDALI-ME20X-U	53
4.1.2	LDALI-E101-U, LDALI-3101-U and LDALI-E101-U	53
4.1.3	LDALI-3E10X and LDALI-ME204	54
4.2	Product Label.....	55
4.3	Mounting	55
4.4	LED signals	55
4.4.1	LDALI-3E10X-U and LDALI-ME20X-U	55
4.4.2	LDALI-3E10X and LDALI-ME204	57
4.4.3	LDALI-E101-U, LDALI-3101-U and LDALI-E101-U	58
4.4.4	Wink Action	59
4.5	Buttons.....	59
4.5.1	Status Button	59
4.5.2	DALI Mode Button	59
4.5.3	DALI Channel Button	60
4.5.4	DALI Program Button.....	60
4.6	DIP Switch Settings	60
4.7	Wiring.....	60
5	Workflows for the L-DALI.....	61
5.1.1	On-Line	61
5.1.2	Off-Line.....	62
5.1.3	Replace an L-DALI.....	63
5.1.4	Enable Legacy NM Mode (LDALI-10X only).....	63
5.1.5	Configuration Upload and Download.....	64
6	L-DALI Lighting Application	66
6.1	CEA-709 Interface and Application (LDALI-10X only)	66
6.1.1	Lamp actuator Object #3040	66
6.1.2	Light Sensor Object #1010.....	89
6.1.3	Occupancy Sensor Object #1060.....	91
6.1.4	Constant Light Controller Object #3050	93
6.1.5	Sunblind Controller Object #6111.....	114
6.1.6	Globals #0005	132

6.1.7	Button #0001.....	138
6.2	BACnet Interface and Application (LDALI-20X only).....	140
6.2.1	Interface Version.....	142
6.2.2	Light Output Objects.....	142
6.2.3	Sensor Objects	170
6.2.4	Constant Light Controller	174
6.2.5	Button Objects	188
6.2.6	Sunblind Controller Objects	190
6.3	Web Interface	199
6.3.1	Constant Light Controller Bindings (Commission)	199
6.3.2	Sunblind Controller Bindings (Commission).....	200
6.3.3	Configuration of Button Functions	201
6.3.4	Debug (Config).....	204
7	Security Hardening Guide	206
7.1	Installation Instructions.....	206
7.2	Firmware.....	206
7.3	Ports	206
7.4	Services.....	207
7.5	Logging and Auditing	207
8	Specifications.....	208
8.1	Physical Specifications	208
8.1.1	LDALI-3E10X-U/LDALI-ME20X-U	208
8.1.2	LDALI-3E10X/LDALI-ME204.....	208
8.1.3	LDALI-3101-U/LDALI-E101-U/LDALI-E201-U	209
8.2	Resource Limits.....	209
8.3	FCC Warning	210
8.4	CE Warning.....	210
9	References	211
10	Revision History.....	212

Abbreviations

100BaseT	100 Mbps Ethernet network with RJ-45 plug
Aggregation.....	Collection of several CEA-709 packets into a single CEA-852 packet
AST.....	Alarming, Scheduling, Trending
BACnet	Building Automation and Control Network
BBMD.....	BACnet Broadcast Management Device
BDT	Broadcast Distribution Table
CA.....	Certification Authority
CC	Configuration Client, also known as CN/IP Device
CEA-709	Protocol standard for LONWORKS networks
CEA-852	Protocol standard for tunneling CEA-709 packets over IP channels
CN.....	Control Network
CN/IP	Control Network over IP
CN/IP Channel.....	logical IP channels that tunnels CEA-709 packets according CEA-852
CN/IP packet.....	IP packet that tunnels one or multiple CEA-709 packet(s)
COV	change-of-value
CR	Channel Routing
CS.....	Configuration Server that manages CEA-852 IP devices
DA.....	Data Access
DALI.....	Digital Addressable Lighting Interface, see IEC 62386
DHCP.....	Dynamic Host Configuration Protocol, RFC 2131, RFC 2132
DiiA	Digital Illumination Interface Association
DL	Data Logger, Datenlogger (Webservice)
DNS	Domain Name Server, RFC 1034
DST.....	Daylight Saving Time
EEP	EnOcean Equipment Profile
GMT.....	Greenwich Mean Time
IP.....	Internet Protocol
IP-852.....	Logical IP-Channel, for tunneling CEA-709 packets according to CEA-852
LAN	Local Area Network
LSD Tool	LOYTEC System Diagnostics Tool
MAC	Media Access Control
MD5.....	Message Digest 5, a secure hash function, see Internet RFC 1321
MS/TP.....	Master/Slave Token Passing (this is a BACnet data link layer)
NAT	Network Address Translation, see Internet RFC 1631
NV.....	Network Variable
OPC.....	Open Process Control
OPC UA.....	OPC Unified Architecture
PEM	Privacy Enhanced Mail
RNI.....	Remote Network Interface

RSTP	Rapid Spanning Tree Protocol (Standard IEEE 802.1D-2004)
RTT	Round-Trip Time
RTU	Remote Terminal Unit
SCPT	Standard Configuration Property Type
SL	Send List
SMI.....	Standard Motor Interface
SMTP	Simple Mail Transfer Protocol
SNTP	Simple Network Time Protocol
SNVT	Standard Network Variable Type
SSH.....	Secure Shell
SSL.....	Secure Socket Layer
TLS.....	Transport Layer Security
UCPT.....	User-defined Configuration Property Type
UI.....	User Interface
UNVT.....	User-Defined Network Variable Type
UTC.....	Universal Time Coordinated
WLAN.....	Wireless LAN
XML	eXtensible Markup Language

1 Introduction

1.1 Overview

The L-DALI controllers for LONMARK and BACnet systems are DALI gateways with built-in light controller functionality.

DALI (Digital Addressable Lighting Interface) is defined in the international standard IEC 62386. It is used to dim and switch luminaries from most leading manufacturers. DALI also supports devices like multi-sensors (e.g. for brightness, occupancy, etc.) and intelligent switches.

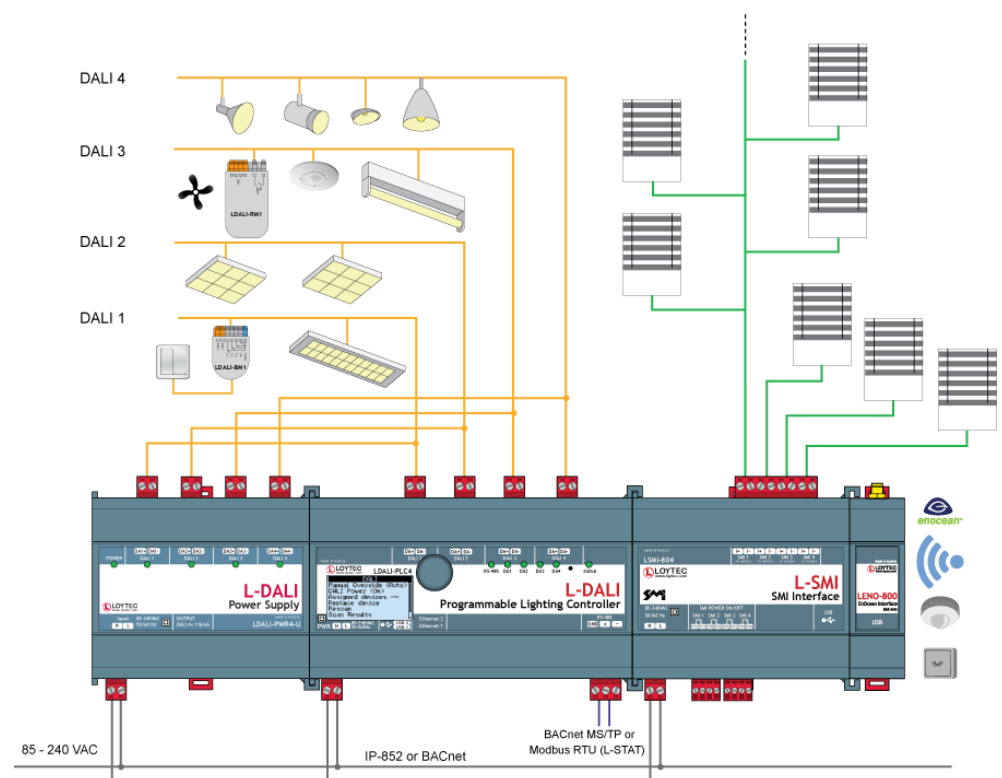

Figure 1: L-DALI supports up to four DALI channels.

The L-DALI lineup features 1, 2, or 4 independent DALI channels. Up to 64 DALI-based luminaries per DALI channel can be controlled individually or via 16 groups. All luminaries are monitored for lamp defect. L-DALI can provide this information to the Building Management System (BMS) through its NV or BACnet interface respectively. For CEA-709 communication IP-852 (Ethernet/IP) and TP/FT-10 are supported, for BACnet

communication BACnet/IP and BACnet MS/TP are supported. In addition all L-DALI models support Modbus/TCP for integration into an existing Modbus SCADA system.

LDALI-3E101-U, LDALI-3E102-U, and LDALI-3E104-U are gateways connecting a DALI network to a CEA-709/LONMARK network, LDALI-ME201-U and LDALI-ME204-U are gateways connecting a DALI network to a BACnet network. On the DALI network the L-DALI controller represents a DALI master controller. On the CEA-709 or BACnet network the L-DALI controller offers a NV interface or a BACnet server objects respectively to control the ballasts and the sensors connected for the DALI network.

The constant light controller (LONMARK functional profile #3050, BACnet Loop object) allows controlling DALI ballasts with lighting nodes on the CEA-709 or BACnet network. Occupancy and lux-level sensors for constant light control and buttons for manual operation can be integrated via the CEA-709/BACnet interface, directly on the DALI side or via EnOcean using the LENO-80x interface.

Using the LSMI-804 SMI interface up to four SMI channels with up to 16 SMI drives each can be connected to an L-DALI controller. The built-in sunblind controller application (LONMARK functional profile #6111, various BACnet objects) can be used to control these SMI drives. Interaction between the sunblind and constant light controller applications allows adjusting sunblinds depending on the constant light controller output, e.g. for energy saving concepts.

L-DALI supports automation functions such as alarming, scheduling, and trending. The L-DALI controllers offer local scheduling services including the possibility to configure several local and remote 24 hour schedulers through the Web UI. Alarming includes the functionality to generate, deliver, acknowledge, and display alarm conditions and logs regardless whether the condition comes from the DALI or the CEA-709/BACnet network. The trending capability includes periodic and event triggered data logging of values and time stamps. Alarms and trend data are stored on the device accessible via an FTP connection as CSV files.

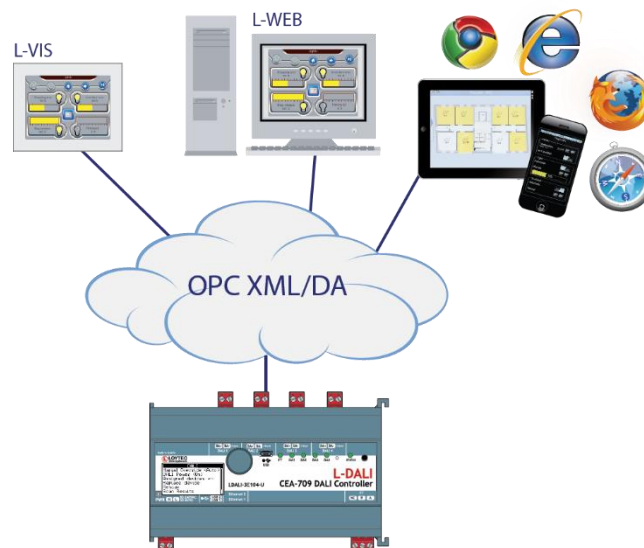

Figure 2: Using L-DALI together with the L-WEB product family.

L-DALI devices can be integrated with LWEB-802/803 visualization and LWEB-900 using OPC XML-DA. LWEB-802/803 and LWEB-900 can be used for visualization of an L-DALI based lighting control system. LWEB-900 offers additional functionality like saving trend and log files for long term storage, easy managing of remote schedulers and

calendars, data analysis and report generation. L-DALI supports event-driven e-mail notification as a result of a predefined action triggered by a specific status or an exceeded high limit. E-mail notification can also be used to forward trend and log files to central SQL databases for long term storage (see LWEB-900 for details).

L-DALI supports common mathematical operations and functions, as well as Boolean expressions.

Some lighting controller applications do not need a connection to the CEA-709 or BACnet network. Therefore the L-DALI controller can control a DALI network as a standalone device with the aid of the supported automation functions (alarming, scheduling, and trending). Connected to an IP network, remote access allows to set parameters and to read the system status.

The complete configuration can be done through the built-in Web server or via a PC based configuration software (LINX Configurator). The commissioning and maintenance of the DALI system can be done using a standard Web browser on a PC or table computer.

The L-DALI offers the following features:

- DALI gateway and controller
- Supports 1, 2, or 4 DALI channels (dependent on model)
- Integrated DALI bus power supply, can be switched off, 16 V DC, 230 mA (guaranteed), 250 mA (maximum) (LDALI-3E101-U/LDALI-ME201-U only)
- Direct control of up to 64 DALI devices per DALI channel
- Direct control of up to 16 DALI groups per DALI channel
- Scene control for up to 16 groups and one broadcast scene per DALI channel
- Detect lamp and ballast failure on DALI luminaries and signals
- Simple replacement of (broken) DALI devices (no configuration tool required)
- DALI multi-master capable
- Support for DALI sensors and buttons
- Supports DALI-2 standard
- Built-in DALI protocol analyzer
- Direct control of SMI drives using LSMI-804
- Integration of EnOcean multi-sensors and push-buttons using LENO-80x
- Built-in constant light controller application
- Built-in sunblind controller application
- Alarming, Scheduling, and Trending (AST™)
- Common mathematical operations and functions as well as Boolean expressions
- Event-driven e-mail notification

- Periodic testing of emergency lights
- Lamp burn-in mode
- Calculation of energy consumption and run-hours
- OPC XML/DA (L-WEB integration)
- Supports WLAN through LWLAN-800 Interface
- Configuration via Web interface
- Firmware update via CEA-709 or Ethernet port
- DIN rail mountable

LONMARK/CEA-709 models only:

- Fully compliant with CEA-709, CEA-852, and EN 14908 standard
- Supports LONMARK TP/FT-10 or CEA-852 Ethernet (IP-852) channels (selectable)
- Control of DALI capable ballasts via NVs
- Retrieve information from DALI capable sensors via NVs
- Supports LONMARK Functional Profiles:
 - Lamp Actuator #3040
 - Light Sensor #1010
 - Occupancy Sensor #1060
 - Constant Light Controller #3050
 - Sunblind Controller #6111
 - Open Loop Sensor (button) #1
 - Scheduler #0007
 - Calendar #0006

BACnet models only:

- Fully compliant with BACnet standards ANSI/ASHRAE 135-2012 and ISO 16484-5:2012
- BACnet/IP or BACnet MS/TP (selectable)
- B-BC (BACnet Building Controller) functionality, BTL certified
- Control of DALI capable ballasts and sensors via BACnet server objects

- Retrieve information from DALI capable sensors via BACnet server objects
- BACnet client functionality (configurable)
- Supports the following BACnet server objects:
 - Analog Output objects to control DALI ballasts, groups, and channels
 - Multi-State Output objects for scene control of DALI groups and channels
 - Analog Input objects providing feedback from DALI ballast, groups, and channels
 - Analog Input objects providing status information from DALI groups and channels
 - Accumulator objects providing estimated energy usage of DALI groups and channels
 - Multi-State Output objects to issue commands (start/stop emergency test or burn-in, change color temperature, etc.) to DALI ballasts, groups and channels
 - Analog Input objects providing battery status of emergency ballasts, groups
 - Analog Input object providing lux level information from supported DALI sensors
 - Binary Input objects providing occupancy information from supported DALI sensors
 - Loop objects providing constant light controller functionality
 - Binary Input objects providing button information from supported DALI buttons
 - Various objects to control sunblinds

1.2 L-DALI Models

This Section provides an overview of the different L-DALI models in Table 1. This table identifies the different features of the L-DALI models. Models that possess a certain feature have a check mark (✓) in the respective column. If a feature is not available in the particular model, the column is left blank.

Feature \ Model	3E102	3E104	3101-U	E101-U	ME204	E201-U	3E101-U	3E102-U	3E104-U	ME201-U	ME204-U
DALI Power Supply			✓	✓		✓	✓			✓	
DALI Channels	2	4	1	1	4	1	1	2	4	1	4
DALI Emergency Lights Test	✓	✓	✓	✓	✓	✓	✓	✓	✓	✓	✓
Constant Light Controller	✓	✓	✓	✓	✓	✓	✓	✓	✓	✓	✓
Sunblind Controller	✓	✓	✓	✓			✓	✓	✓	✓	✓
LCD Display with Jog Dial			✓	✓		✓	✓	✓	✓	✓	✓
LON TP/FT-10	✓	✓	✓				✓	✓	✓		
LON IP-852 (Ethernet/IP)	✓	✓		✓			✓	✓	✓		
BACnet MS/TP					✓					✓	✓
BACnet/IP (Ethernet/IP)					✓	✓				✓	✓
Modbus TCP							✓	✓	✓	✓	✓
Configuration via WEB UI	✓	✓		✓	✓	✓	✓	✓	✓	✓	✓
Configuration via Software	✓	✓	✓	✓	✓	✓	✓	✓	✓	✓	✓
Console connector	✓	✓			✓						
LWEB-802/803 Hosting							✓	✓	✓	✓	✓
OPC XML-DA	✓	✓		✓	✓	✓	✓	✓	✓	✓	✓
OPC UA							✓	✓	✓	✓	✓
SSH, HTTPS, Firewall							✓	✓	✓	✓	✓
WLAN (with LWLAN-80x)							✓	✓	✓	✓	✓
Ethernet Switch/Hub				✓		✓	✓	✓	✓	✓	✓
EnOcean (with LENO-80x)							✓	✓	✓	✓	✓
SMI (with LSMI-804)							✓	✓	✓	✓	✓
DALI-2 support							✓	✓	✓	✓	✓

Table 1: Available features in different L-DALI models.

Important: *In the following text models with BACnet interface are referred to as LDALI-20X and models with LONMARK/CEA-709 interface are referred to as LDALI-10X.*

1.3 Scope

This document covers L-DALI devices with firmware version 6.4 and the L-INX Configuration Software version 6.4. Basic device operations are covered in the LOYTEC Device User Manual [1] and device configuration using the PC configuration software is covered by the LINX Configurator User Manual [2].

2 What's New in L-DALI

This section describes the major changes and new features. For a full list of changes refer to the Readme file.

2.1 New in L-DALI 6.4

Unified Firmware

The L-DALI firmware is now included in the unified LOYTEC controller firmware package for L-INX, L-ROC, L-GATE and L-IOB devices.

Colour control via data points

On L-DALI models with BACnet interface (LDALI-20X), *Hue* and *Saturation* data points were added to the Lamp Actuator, Group Actuator and Channel Actuator objects, allowing easy control of DALI ballasts with colour control functionality (device type 8, DT8). For more information, see Section 6.2.2.10.

On L-DALI models with LONMARK interface (LDALI-10X), the network variables *nviGPSetting* (Group Actuator) and *nviCHSetting* (Channel Actuator) can now be used to change output colour. For more information, see Section 6.1.1.11.

Support for DALI primary-N and RGBWAF colour control options

In addition to the DALI colour control options *colour temperature Tc* and *xy-coordinate* the L-DALI now supports DALI device type 8 (DT8) devices using *primary-N* and *RGBWAF* colour control. Colour control is possible via scenes or via the new data points for colour control (see above).

Improved DALI Installation web-UI

The DALI Installation web-UI was redesigned for improved usability (see Figure 3). Besides many more smaller improvements buttons and selection check boxes were moved to left side of screen to avoid scrolling. For more information on the DALI Installation web-UI see the LOYTEC Device User Manual [1].

Channel 1 Channel 2 Channel 3 Channel 4

Wink duration: 30 sec
 Mains-Off handling: Disabled
 Mains-On delay: 600 ms
 Mains-Off delay: 0 min
 DALI Power: Off
 Manual Override: Auto

Save Reload

Devices in Database (bus power usage assigned/total: 11.2/11.2 mA) Filter by name...

Action on Selected: Execute Reset

#	Name	Location	Type	Status	Serial No.	Short Addr.	Run Hrs	Nom. Pwr	Bus Pwr
Lamps									
0	Lamp_Room303_1		LED device	OK: 100%	1982081025	00	0 h	0 W	2 mA
1	Lamp_Room303_2		LED device	OK: 100%	1982081025	01	0 h	0 W	2 mA
Sensors									
2	Multi-Sensor_Room303		LDALI-MS1	OK: 1017 lux unoccupied	1073742080	L00	-	-	4.1 mA
Buttons									
3	Button_Room303_1		LDALI-BM1	OK: -	1010090	L00	-	-	3.1 mA
4	Button_Room303_2		LDALI-MS1 IRT	OK: -	1073742080	L00	-	-	-

Scanned Devices not in Database

Scan Clear Results Save Assignment

Name	Type	Serial No.	Short Addr.
Lamp_Room303_3	LED device	1982081025	02
Lamp_Room303_4	LED device	1982081025	03

Unassigned Devices Filter by name...

Search

Name	Location	Type	Serial No.	Bus Pwr
Lamps				
Lamp_Room303_3				
Lamp_Room303_4				
Sensors				
Temp-Sensor_Room303				
LDALI-MS2_Room303				
Buttons				
LDALI-BM2_Room303				
LDALI-MS2 buttons_Room303				

Figure 3: New DALI Installation web-UI layout.

Localized Web Interface

The entire Web interface of the device has been localized to German, French, and Chinese language. Simply change the language on the LCD display or directly on the Web interface via the new flag symbol on the upper right corner. Changing language is instant and does not require a reboot.

Device Info

English
 Deutsch
 Français
 中文 (简体)
 中文 (繁體, 台灣)

General Info		
Product	LINX-112, Firmware 6.4.0	2018-05-02 16:01:00
Hostname	BSV-CTS06, 192.168.2.245	
Serial Number	029503-000AB005A74F	
Free RAM, swap, flash	216884 KB, 262140 KB, 993728 KB	
CPU, temp, supply	9%, 39°C, 23.1V	
NTP status	in-sync	
Uptime	1 day, 00:06:59	

Figure 4: Language selection on the Web interface

Safe Reboot and Auto-Login

Changing IP settings and rebooting could end in a device unreachable, if something was different than expected. The new safe reboot feature helps out by reverting the changes made, if not logged in on the Web interface within 5 minutes after the reboot. Locking oneself out by entering a mistaken IP address is no longer possible.



Figure 5: Safe reboot screen suggesting new IP address.

Another new feature that helps getting logged in again is the session auto-login. After a device has rebooted the Web interface restores the session and automatically logs in again. Even when changing a static IP address the device tries to connect to the new IP or suggests links for opening the device info page under the new IP address.

Backup before Upgrade

The firmware upgrade feature has been made safer by creating a backup before executing the upgrade. This feature has been added to firmware and Configurator upgrade paths. It is, however, optional and can be turned off by deselecting the check box.

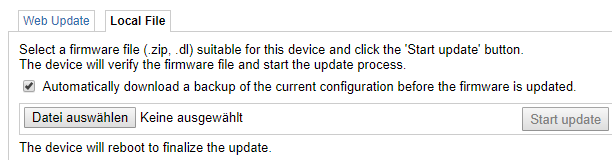

Figure 6: Backup before Upgrade on the Web interface.

Support Custom Protocols and IoT by Scripting

All L-DALI models now include a JavaScript-based scripting engine. This engine allows users to implement their own protocol support for the IoT world using RESTful APIs, JSON or Web services. The LOYTEC data point server allows integrating data points into the scripting language using the dpal-js API. The script modules can be embedded into and deployed along with the data point configuration.

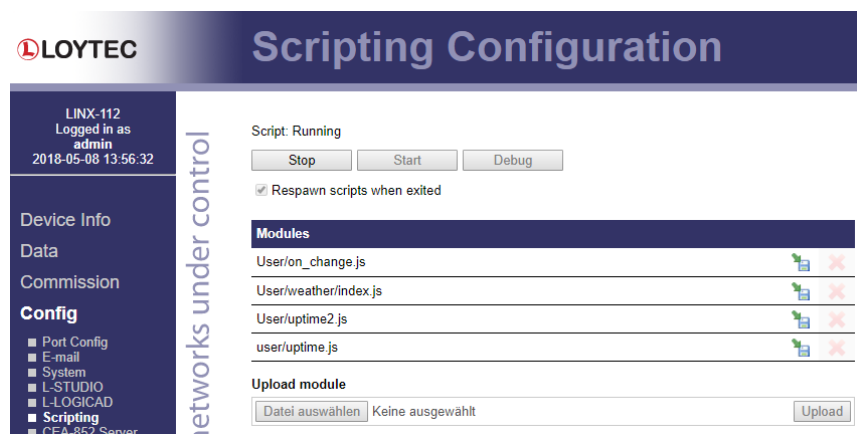

Figure 7: Web interface for scripting engine

The Web interface of the device offers an overview of installed script modules and allows starting scripts in debug mode. Use the Google Chrome inspector to debug JavaScript on

the device. For more information read the new Scripting Chapter in the LINX Configurator User Manual [2].

2.2 New in L-DALI 6.3

Support for DALI 2.0 Input Devices

The L-DALI now supports DALI input device based on the new DALI-2 standard. The term “input devices” covers sensors (occupancy, lux, etc.) and buttons (push-buttons, switches, sliders, etc.).

Prior to DALI-2 sensors and buttons were not covered by the DALI standard. Different vendors, including LOYTEC, were using proprietary extensions of the DALI protocol to be able to connect this type of devices to the DALI network. As each vendor was using its own proprietary extension the L-DALI controllers were supporting many but by far not all such proprietary extensions. Supported sensors and buttons were listed in the “L-DALI Compatibility List (AN011E)” [10].

With DALI-2 those type of devices is standardized in the IEC 62386-103, with different profiles (push-button, absolute input, occupancy sensor, lux sensor, etc.) specified in the parts IEC 62386-3XX (XX = 00..99). Similar to DALI ballasts, this allows supporting a wide range of sensors and button devices from many different vendors in the L-DALI as long as they are compliant to the DALI-2 standard.

To ensure device interoperability DALI-2 compliant devices – input devices and ballasts – can be certified by the Digital Illumination Interface Association (DiiA). Only certified devices may bear the DALI-2 logo shown in Figure 8 and are listed in the product database on the DiiA website (<https://www.digitalilluminationinterface.org>).



Figure 8: DALI-2 Logo.

LOYTEC recommends using only DALI-2 certified devices wherever possible. For more information on DALI-2 input devices support see the LOYTEC Device User Manual [1].

Improved Button Functions

In addition to DALI buttons, button function are now applicable to EnOcean buttons and binary data points. Binary data points can be used to configure button functions for buttons created in L-WEB graphic projects, for buttons connected to digital inputs of remote IO modules and for DALI buttons connected to DALI channels on other LDALI controllers. Consequently, the button function configuration was moved to a separate page on the web-UI (see Figure 9).

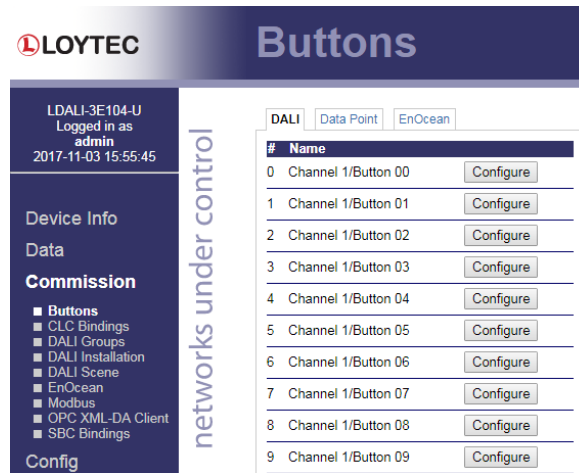

Figure 9: Button function configuration web-UI.

Further, new button function allowing control of sunblind were added. These button functions interact with the sunblind controller application of the L-DALI.

For more information on the button functions see Section 6.3.3.

Bindings Support for EnOcean Devices

Any analog data point can now be used in Constant Light Controller bindings and Sunblind Controller bindings as lux level inputs. Similar any binary data point can be used as occupancy input (see Figure 10). This allows to use EnOcean multi-sensors in a more convenient way with the L-DALI's lighting and sunblind control applications. For more information please refer to Sections 6.3.1 and 6.3.2.

Figure 10: Use data point as CLC input.

New Objects for BACnet Interface on LDALI-20X Models

New objects were added to the BACnet interface of the LDALI-20X models:

- *Multi-State Output objects (see Section 6.2.2.16)*: This object allows to issue commands to single DALI ballasts, DALI groups or DALI channels (start/stop emergency test or burn-in, change color temperature, etc.).
- *Analog Input objects (see Section 6.2.2.17)*: This object allows to determine the battery status of self-contained emergency lights.

With these two new object types, additional functionality becomes available via the BACnet interface:

- Starting and stopping self-tests of DALI self-contained emergency lights.
- Reading the battery status of DALI self-contained emergency lights.
- Starting and stopping the burn-in function.
- Resetting run hours and energy counters.

- Relative dimming (up/down).
- Relative changes of colour temperature (warmer/cooler) for DALI lamps with tunable white support.

In addition, the L-DALI's project settings allow configuring which BACnet object are available with a much finer granularity (see Figure 11). This allows removing BACnet objects not required in a specific application, thus, reducing the number of objects on the L-DALI's BACnet interface. For more information see Section 6.2.

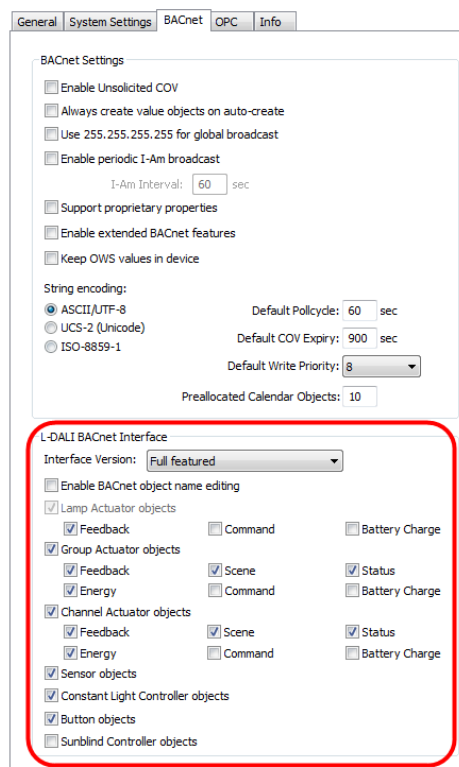

Figure 11: BACnet interface configuration.

Calculation of Sun Position

The L-DALI has two new system registers for sun azimuth and elevation, which are calculated based on the current day time and the geographical location. These system registers can be used for the corresponding inputs of the sunblind controller application. For more information see the LINX Configurator User Manual [2].

LCD Interface

The user interface on the LCD display has been extended by a firmware upgrade menu. This menu allows installing a new firmware image from an attached USB memory stick. This is beneficial for WLAN-only devices. When plugging in a USB memory stick, a menu pops up (Figure 12) on the LCD interface that shows selected quick options, including firmware upgrade and backup.

```

USB Storage Features
Menu ****
Firmware Update
Restore

```

Figure 12: LCD pop-up menu for USB storage

Web UI

The data point details page on the Web UI provides write usage information. This information can now be used to determine by which objects a certain data point is being written to. The Web UI design has also been reworked according to the latest security standards, now suggesting usage of strong passwords.

2.3 New in L-DALI 6.1

Enhanced Sunblind Functionality

The LDALI-ME20X-U and LDALI-3E10X-U models offer additional functionality to control sunblinds in addition to the artificial light in a room or area:

- SMI Support:** The LDALI-ME20X-U and LDALI-3E10X-U models now support the LSMI-804 interface. This is a four-channel SMI interface connected to the USB port of the L-DALI. SMI (Standardized Motor Interface) is a bus system used for controlling sunblinds. The LSMI-804 also contains four relays for SMI channel power-on functionality. This saves energy while the SMI bus is idle. The LINX Configurator provides SMI device templates, which can be commissioned on the L-DALI Web interface. The Web interface supports manual address assignment, scanning for SMI devices and calibration. For more information on SMI read the respective Chapters in the LOYTEC Device User Manual [1] and the LINX Configurator User Manual [2].
- BACnet Sunblind Controller:** The L-DALI sunblind controller application was equipped with a BACnet interface and added to the L-DALI BACnet models with SMI support. The BACnet sunblind controller application provides similar functionality as the LONMARK version (e.g. glare protection, heating/cooling optimization, constant light controller interaction etc.). For more information on the BACnet sunblind controller application see Section 6.2.6.

Type	Binding
Sunblind Controller 0 (Room_302_ctrl)	
Lux sensor	<input type="text" value="Ch1: Light Sensor 0 (Room_302_sensor)"/> 696 lux
Occupancy	<input type="text" value="Ch1: Occupancy Sensor 0 (Room_302_sensor 0)"/> unoccupied
SMI Device	<input type="text" value="Room_302_sblnd"/>

Figure 13: Sunblind Controller Bindings web UI.

- Sunblind Controller Bindings:** To facilitate the usage of SMI sunblinds with the L-DALI's sunblind controller application a sunblind controller bindings functionality similar to the constant light controller bindings functionality was added to the SMI capable L-DALI models. Using sunblind controller bindings, DALI multi-sensors can be selected as lux and occupancy sensor inputs and SMI devices as an output of a sunblind controller instance. For more information on sunblind controller bindings see Section 6.3.2 and the respective Chapters in the LINX Configurator User Manual [2].

With the enhance sunblind controller functionality and SMI support the L-DALI becomes a powerful solution to fully integrate lights and sunblind control of a room or an area.

Constant Light Controller Improvements

The constant light controller application was extended by some new functions:

- A new regulator and controller mode was added, which does not switch on lights automatically when an area becomes occupied but requires manual activation (e.g. by a button). When the area becomes unoccupied lights are switched off. Depending on whether the CLC stays active during times with enough natural light or requires manual activation in any case when lights were switched off, the mode is called `REGULATOR_MANUAL/CONTROL_MANUAL` or `REGULATOR_MANUAL_LUX/CONTROL_MANUAL_LUX` respectively. For more information on the new operating modes see Sections 6.1.4.3 (LONMARK) and 6.2.4.3 (BACnet), respectively.
- The new function “neighboring CLCs” allows defining adjacent Constant Light Controller instances as typically found in open office spaces, where different CLC instances are used to control the different zones of the space. Whenever a zone is occupied and its lights are on, all neighboring zones/CLCs are also kept at a defined minimum level even if they are not occupied. Neighboring CLC instances can be configured using the Constant Light Controller Bindings web UI (see Section 6.3.1) and the DALI Parameters tab in the LINX Configurator (LINX Configurator User Manual [2]).
- The artificial light factor of a constant light controller parameterizes the amount of light (in lux) provided by the artificial light sources controlled by the controller at a certain dim level. The new firmware will try to determine the artificial light factor automatically instead of using a default value for this parameter. Thus, the calibration process to determine the artificial light factor in untypical lighting setups can be omitted.

User NVs on LDALI-10X Models

On LDALI-10X models (LONMARK) user NVs can be created in addition to the static interface of the controller. The NVs created can be used as inputs and outputs to Math objects and similar functions of the L-DALI controller, adding more flexibility when custom adoptions to the standard lighting and sunblind application of the L-DALI are required.

Tunable White Support on LDALI-20X Models

On LDALI-20X models, a new custom property (*Colour_Temp*) was added to Lamp Actuator, Group Actuator and Channel Actuator objects which allows changing the color temperature of DALI tunable white lights based on the DALI standard IEC 62386 209 (Colour control, device type 8, DT8). See Section 6.2.2.10 for details.

Selective Backup and Restore

The backup and restore interface on the Web interface has been extended by content options. It is now possible to decide whether a created backup shall contain passwords, IP settings or historical data (trend logs, alarm logs). Also when restoring a backup archive it can be selected whether password and IP settings shall be accepted from the backup or not. This makes it easier to replicate devices without sacrificing the IP configuration and password settings. An example is shown in Figure 14.

Backup Configuration

Press the backup button to download the current configuration and store it as a file on your computer.

Include passwords in backup
 Include IP settings in backup
 Include trend logs in backup

Restore Configuration

To restore a configuration select the backup file (e.g. backup.zip) and press the restore button.

Filename: Keine ausgewählt

Restore passwords
 Restore IP configuration

Figure 14: Backup and restore options on the Web UI.

Advanced WLAN Mesh Configuration

The WLAN Mesh configuration has been enhanced by a graphical floorplan editor as well as an online monitor of inter-link communication quality. This tool allows not only easier setup of a Mesh network but also simple troubleshooting by identifying radio bottleneck between Mesh points (see Figure 15).

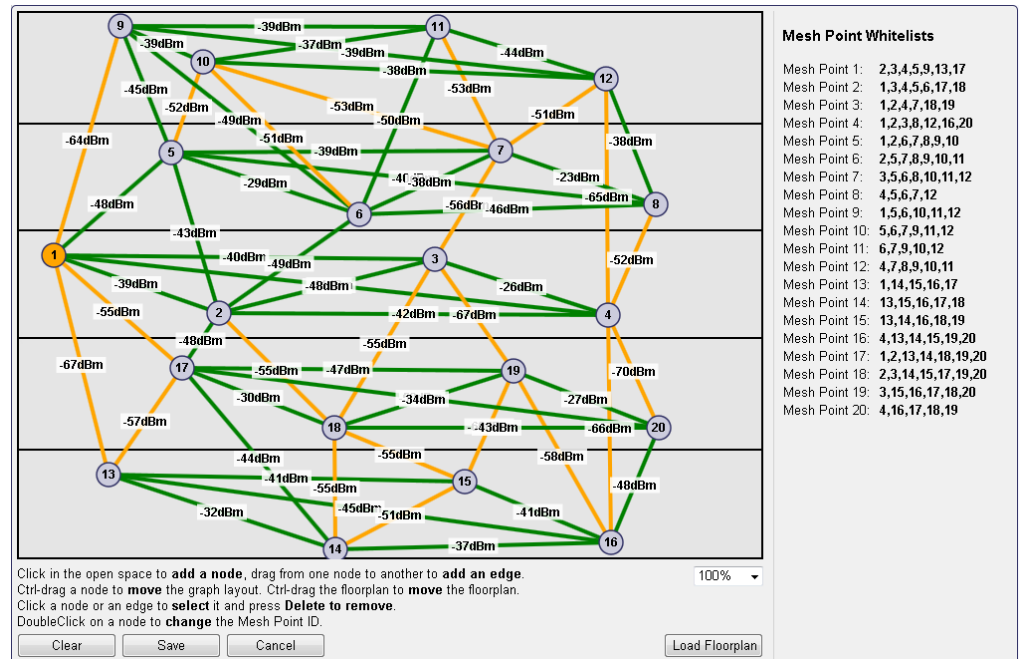

Figure 15: Mesh floorplan and online link quality monitor

LCD Interface

The user interface on the LCD display has been localized for the Chinese simplified and traditional language sets. The language can be selected from the main page and is switched immediately without a device reboot.

Another feature on the LCD display is the option to rotate the display 180 degrees. This is a useful setting, if the device is mounted upside down.

2.4 New in L-DALI 6.0

New User Manual Structure

The L-DALI User Manual has been split up into three parts: The L-DALI User Manual, which now covers the specific functions of the L-DALI device models. The LINX Configurator User Manual [2] is a common description for using the Configurator software for the L-INX, L-GATE, L-ROC, L-IOB, and L-DALI product line. And the LOYTEC Device User Manual [1] covers hardware, Web interface, LCD display and operating interfaces topics common to all LOYTEC devices.

New L-DALI Models

A new generation of L-DALI models replaces the existing models. The LDALI-ME20X-U replaces the LDALI-ME204 and LDALI-E201-U, while the LDALI-3E10X-U models replace the LDALI-3E104, LDALI-3E102, LDALI-E101-U and LDALI-3101-U models respectively. The new generation offers a higher performance and has more resources available. It therefore allows to host LWEB-802/803 projects directly on the device. Furthermore, it comes with a number of interfaces (USB, LIOB-Connect), which allows extending the capabilities of the device by connecting different peripherals directly to the controller, e.g. LENO-80x modules add EnOcean, while the LWLAN-800 module provides Wi-Fi connectivity.

Constant Light Controller Improvements

The constant light controller application was extended by some new functions:

- The constant light controller can be reactivated from manual override by recalling a special scene on a linked group.
- A new data point – *nvoOccupState* (CEA-709/LDALI-10X) or *Occupancy_State* (BACnet/LDALI-20X) – shows the current occupancy state as calculated by the constant light controller application.
- Two new data points – *Override* and *Auto_Mode* – were added to the constant light controller BACnet interface (LDALI-20X) to provide similar functionality as via the CEA-709/LONMARK interface (LDALI-10X).

New DALI Button Functions

The state of a button device input can now be forwarded to a BACnet Binary Input object as an alternative to directly control DALI lights on LDALI-20X models, too (see Section 6.2.5).

DALI Status CSV-File

A new file on the device provides the current status of the devices on the DALI channel in CSV file format. The file is dynamically generated when read and therefore always reflects the most recent status of all devices. It can be downloaded from the device (e.g. via FTP) or sent as an e-mail attachment. In addition to detailed status and error information on every ballast, the file contains test results and battery status for the DALI emergency lights on the channel.

DALI Protocol Analyzer

A DALI protocol analyzer was added to the LINX Configurator and the devices web-UI. In the LINX Configurator the protocol analyzer is available via the DALI Installation tab, while on the web-UI it is available via the DALI statistics Web interface. Logging can be

started and stopped. Filters allow showing only relevant traffic. Protocol logs can be stored in a disk file in CSV format.

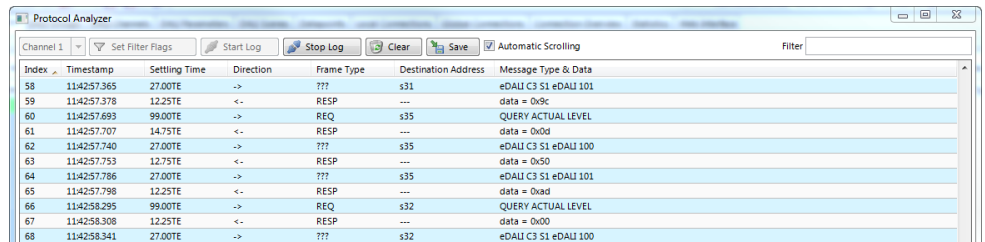

Index	Timestamp	Setting Time	Direction	Frame Type	Destination Address	Message Type & Data
58	11:42:57.365	27.00TE	->	???	s31	eDALI C3 S1 eDALI 101
59	11:42:57.378	12.25TE	<-	RESP	---	data = 0x9c
60	11:42:57.693	99.00TE	->	REQ	s35	QUERY ACTUAL LEVEL
61	11:42:57.707	14.75TE	<-	RESP	---	data = 0x0d
62	11:42:57.740	27.00TE	->	???	s35	eDALI C3 S1 eDALI 100
63	11:42:57.753	12.75TE	<-	RESP	---	data = 0x50
64	11:42:57.786	27.00TE	->	???	s35	eDALI C3 S1 eDALI 101
65	11:42:57.796	12.25TE	<-	RESP	---	data = 0x0d
66	11:42:58.295	99.00TE	->	REQ	s32	QUERY ACTUAL LEVEL
67	11:42:58.308	12.25TE	<-	RESP	---	data = 0x00
68	11:42:58.341	27.00TE	->	???	s32	eDALI C3 S1 eDALI 100

Figure 16: LINX Configurator DALI protocol analyzer window.

DALI Scene Tab in LINX Configurator

DALI scene configuration tab was added to the LINX Configurator. Similar to the DALI scene web-UI introduced in L-DALI firmware version 5.2 it also supports colour scenes with colour temperature and changeable light colour. Scenes can be configured online and offline.

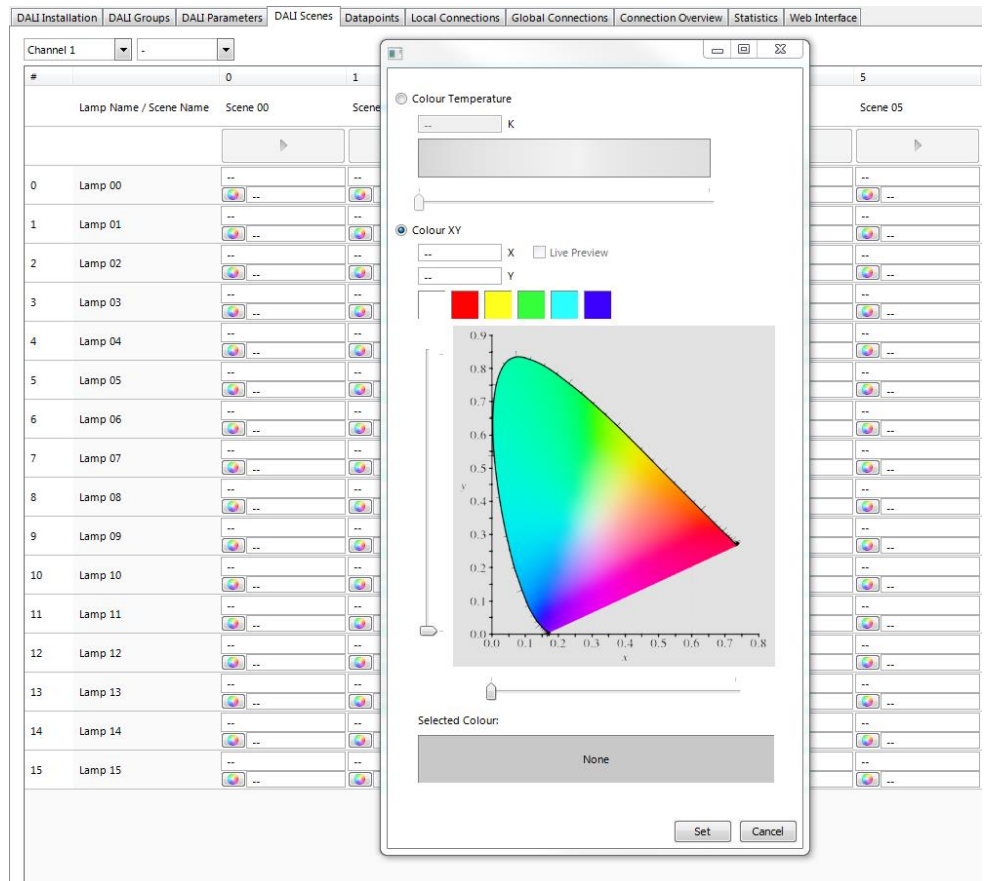

Figure 17: LINX Configurator DALI scene configuration.

DALI Physical Selection Workflow support in LINX Configurator

Identification of a DALI sensor or DALI button device via physical selection is now also possible via the LINX Configurator software.

Override Function for Data Points

The data point model in LOYTEC devices has been extended with a manual override function. On the Web interface and on the LCD display data point values can be overridden to manual values. If an override value is set, the running control logic no longer affects the data point value, neither does network communication. The override value is in effect until it is removed again by the user.

Data Point Details	
Path	/CEA709 DALI Channel 1/Datapoints/Group Actuators/Group Actuator 0/nviGPValue
Name	nviGPValue
Description	Used to set up value of the group
Direction	input
Type	analog
Value	<input type="text" value="100"/> % <input type="button" value="Set"/> <input type="button" value="Set override"/> <input type="button" value="Clear override"/>
	<i>Enter "--" for invalid value</i>
Raw value	<input type="text" value="00 00 59 40 00 00 00 00"/> <input type="button" value="Set"/> <input type="button" value="Set override"/> <input type="button" value="Clear override"/>
	<i>Enter "--" for invalid value</i>
Timestamp	2016-03-02 11:17:23+01:00
State	overridden (0x880a0001)

Figure 18: Overriding a data point on the Web interface.

Manual overrides done on the DALI Installation web-UI (for the channel) or the DALI Groups web-UI result in an override of all the data point which can be used to control any lights on the channel or group respectively (Lamp Actuators, Group Actuators, Channel Actuators).

Enhanced Structure Support on the Web UI

The display of data point structures has been improved on the Web UI. The data point listing shows a textual short version of the structured value instead of a hexadecimal Byte buffer. Also CEA-709 structures of NVs without sub-data points are displayed and can be edited.

2.5 New in L-DALI 5.3

Print L-DALI Configuration

The complete configuration of a L-DALI device including all DALI specific configuration data can now be printed using the Print function of the LINX Configurator. The Print option allows selecting, which parts of the configuration shall be included in the output. The output format can be either HTML or PDF.

New DALI Button Functions

The functions, which can be executed when pressing a DALI button was extended by the function **Auto**. This will reactivate the constant light controller linked to the functions target group in case it was manually overridden.

2.6 New in L-DALI 5.2

LINX Configurator replaces LDALI Configurator

The L-DALI models are now supported by the LINX Configurator PC software. The LDALI Configurator software therefore is no longer available.

LINX Configurator support for LDALI-20X models

The LINX Configurator now supports LDALI-20X models, including DALI offline configuration workflow and the configuration of alarming, scheduling and trend log objects, e-mail templates, math objects, data point connections etc. Custom user registers and BACnet objects can be created and data points belonging to the static L-DALI application interface can be OPC exposed. Further, the BACnet network can be scanned and client maps can be created from local BACnet objects to remote BACnet objects.

Support for LOYTEC LDALI-MS1, LDALI-BM1 and LDALI-RM1

The L-DALI now supports the LDALI-MS1 multi-sensor, the LDALI-BM1 push-button coupler and the LDALI-RM1 relay module. These devices are an optimal addition to the L-DALI controller and allow designing cost effective and flexible DALI lighting systems. For more information on these devices see the corresponding datasheet and the LOYTEC Device User Manual [1].

DALI Button Functions

For DALI button devices supporting configurable button functions these functions can be configured using the Web-UI (online) and the LINX Configurator (online and offline). The following functions are available to control DALI groups (see LOYTEC Device User Manual [1] and LINX Configurator User Manual [2]):

- Dim up, dim down,
- Off,
- On with last dimming value,
- Scene recall: 1–15,
- Dim to a specified value in %,
- Color temperature warmer/colder.

On LDALI-10X models the state of a button device input can be forwarded to a network variable as an alternative to directly control DALI lights (see Section 6.1.7.1).

DALI Scene Configuration

A new page was added to the L-DALI Web-UI allowing configuration of DALI scenes (see LOYTEC Device User Manual [1]). Scene configuration also supports colour scenes with colour temperature and changeable light colour.

DALI Installation Wizards

A DALI search wizard was added to the DALI installation Web-UI to quickly locate and assign DALI devices. When preconfiguring DALI devices in an offline workflow (name, group assignment, DALI parameters etc.) the wizard assists in locating the corresponding physical device once online (see LOYTEC Device User Manual [1]).

On the Constant Light Controller Web-UI a sensor search wizard was added. Once groups were configured to a CLC instance this wizard allows to automatically search for corresponding DALI sensors in the areas lit by these groups (see Section 6.3.1).

Identification of DALI Devices using Physical Selection

Devices which can be physically selected can be identified by selection during the installation and commissioning process of the DALI network. A DALI button can be selected by pressing one of the buttons, an occupancy sensor can be selected by triggering occupancy. Now the last physically selected device is marked in the DALI scan results on the DALI Installation Web-UI and can be therefore identified.

Online Commissioning

The Web interface of the device now provides an online commissioning tool for the respective networking technologies. Using this tool, data point configurations can be created based on placeholder devices, which are marked to be commissioned later. The necessary addressing information can be assigned later on the Web interface by scanning for devices online or be entered manually. Device replacement is also possible in the commissioning Web interface without the need to edit devices in the data point configuration. For more information on the commissioning Web UI please refer to the LOYTEC Device User Manual [1].

Web Interface

The Web interface of the device offers a number of new features:

- A new device info page provides a quick overview of all relevant operational parameters, such as CPU load, active protocols, time synchronization and many more.
- The trend log configuration on the Web UI now also provides a preview tab, which shows a chart of the trend log data. The trend chart allows zoom, scrolling and hiding specific data curves, as shown in Figure 19.

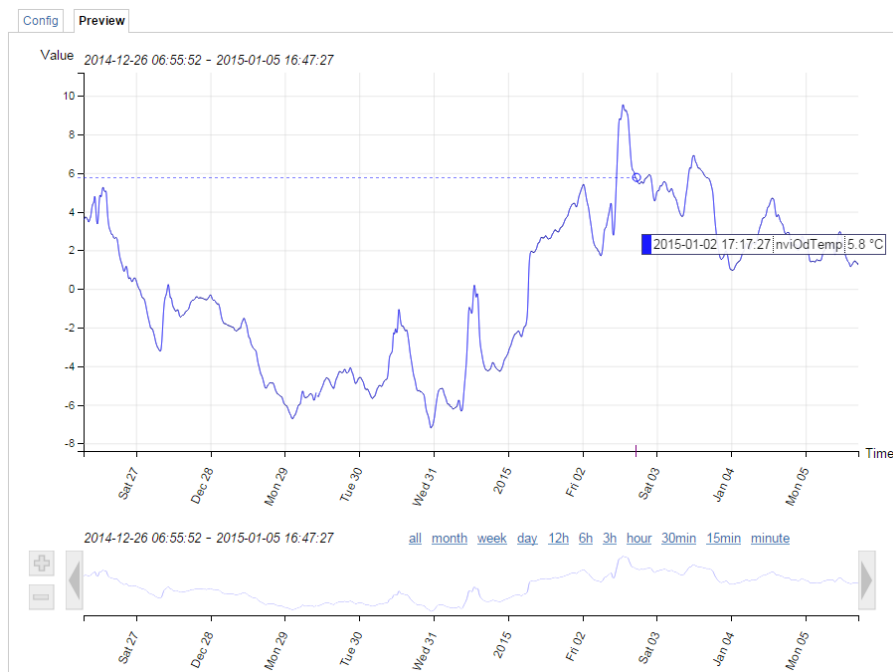

Figure 19: New trend chart on the Web UI

- An improved DALI sensor calibration Web-UI allows to dim DALI groups directly from the sensor calibration Web-UI page making it easier to adjust the artificial light near the calibrated sensor. Further the calibration page can be accessed directly from the CLC Bindings page.

Scheduler

The scheduler objects have been extended by the following new features:

- Color support in BACnet and generic schedulers allows consistent assignment and display of preset colors in L-WEB, L-VIS and the Configurator scheduler UIs.
- Event auto-prune removes passed events, if the capacity of exception events in a scheduler gets low.
- The scheduler default for LONMARK and generic schedulers is extended by a “silent” mode. In this mode the scheduler becomes inactive as soon as the last event is withdrawn. This mode can be used in event-driven scheduler models.
- Generic schedulers allow specifying an existing value preset as the schedule default. LONMARK and BACnet schedulers try identifying a matching preset name from the schedule default value.

Format Strings in E-Mails

Data point variables used in e-mail templates can now use format strings to specify their numeric appearance in the e-mail text.

Storing Project Documentation directly on the Device

A new page on the L-DALI Web-UI allows uploading project documentation and setting-up links to external documentation files (see LOYTEC Device User Manual [1]). Storing documentation directly on the device ensures its availability (e.g. for a service technician) later on.

2.7 New in L-DALI 3.2

This section describes the major changes and new features. For a full list of changes refer to the Readme file.

New Constant Light Controller Modes

The constant light controller application offers some new Modes:

- The modes CONTROL, REGULATOR and PRESENCE are now available in variations with the extension AUTO. In these modes any active override will be automatically relinquished when the room enters “unoccupied” state. This allows to reactivate automatic mode when the room is unoccupied. The light will be switched off and – if necessary – switched on when someone enters the room.
- As a special variation of the AUTO modes, modes with the extension BEDROOM are available. In this mode the manual override is only relinquished when the lights are switched on. This ensures lights are switched off when the room is unoccupied, but stay off when commanded to off manually.
- The mode AMBIENT allows switching on and off lights depending on the measured lux level. It is therefore suitable for decorative lighting (facade illumination, shop window lighting, floor lighting, etc.).

The modes CONTROL and REGULATOR (incl. all variations) now consider the configured Unoccupied Level when switching off, similar to the mode PRESENCE. This allows dimming down to a configured level when the room is unoccupied instead of

switching off. Typical applications are a reception area or similar areas where the light is never turned off completely.

Note: If the an LDALI-10X device was not shipped with firmware 3.2 the new modes are only available after the datapoint configuration was up- and downloaded again using the LINX Configurator.

Further information on the constant light controller modes can be found in Sections 6.1.4.3 and 6.2.4.3 and for the behavior when switching off in Sections 6.1.4.8 and 6.2.4.8.

Overriding the Constant Light Control with DALI Buttons

When using internal manual bindings the constant light controller now detects when one of the groups it controls is dimmed by another DALI master. Such and override is interpreted similar to an override using the CEA-709/LONMARK or BACnet interface. Typically such a DALI master is a DALI push-button coupler or a similar device for manual control of DALI lights. As these devices directly control the DALI groups, they allow local operation of the lights independent of the L-DALI.

Constant Light Controller Bindings across Channels

DALI groups and DALI sensors can be linked to constant lights controller instances using internal bindings across DALI channels (see Sections 6.3.1 and LINX Configurator User Manual [2]).

Support for DALI ballasts with Colour Control

In the LDALI-10X models DALI ballasts of type “colour control” (device type 8, DT8) can be controlled. The LDALI-10X supports devices with changeable colour temperature and with coloured light. The latter can be used for effect lighting, while the previous can be used to simulate the colour temperature of the sun during the course of a day (warmer white during morning and evening, cooler white at noon).

Support for additional DALI Sensors

Support for the ThebenHTS PlanoSpot 360 DALI multi-sensor was added.

Change the DALI Short Address

If required the DALI short address, which was assigned to a DALI device by the L-DALI, can be changed via the Web-UI (see Section LOYTEC Device User Manual [1]).

Generic Scheduler

Generic schedulers – like generic trends and alarms – can now be created, that are neither CEA-709 nor BACnet objects. Generic schedulers appear next to the generic alarm folder and are ready-to-use on any device. This is beneficial for creating technology-independent applications. Generic schedulers can write to any technology as well as data point favorites and are the ideal solution, if configured via LWEB-900 only. For more information on creating generic schedulers refer to the LOYTEC Device User Manual [1].

Web Interface

The Web interface of the device offers a number of new features:

- Live update of values in the data point list. This allows monitoring values without repeated pressing of reload. Data point structures can be expanded or collapsed for better overview.

- Breadcrumb navigation has been added to the data point list. This gives faster access to sub-folders.
- A new firmware upgrade menu on the Web interface allows online checking for firmware updates and upgrading by selecting a local firmware file. All this is possible without starting the Configurator.
- The trend overview page displays current trend log states and provides controls for easy trend data upload in CSV format.
- The DALI group page allows switching groups on and off to test the group assignment.

Application Objects

Application objects such as math objects, e-mail templates, and alarm logs can now be organized in folders. Copy and paste of application objects between Configurators has been improved. Math objects now allow single constants and single variable assignments, such as “=5” or “=v1”. Input variables can be configured to trigger a new calculation or not.

3 Quick-Start Guide

This Chapter contains step-by-step instructions on how to configure the L-DALI for the simple project shown in Figure 20.

The project consists of a single room (Room 306) which is illuminated by four DALI lamps. Two of those lamps form a light band near the windows of the room and the other two lamps form a light band near the corridor. The room is equipped with a DALI multi-sensor which acts as both a light sensor and an occupancy sensor. The build-in constant light controller of the L-DALI device uses the input from the DALI multi-sensor and dims the DALI ballasts accordingly. For manual override a DALI push-button is installed. The sunblind controller is not used in this quick-start example.

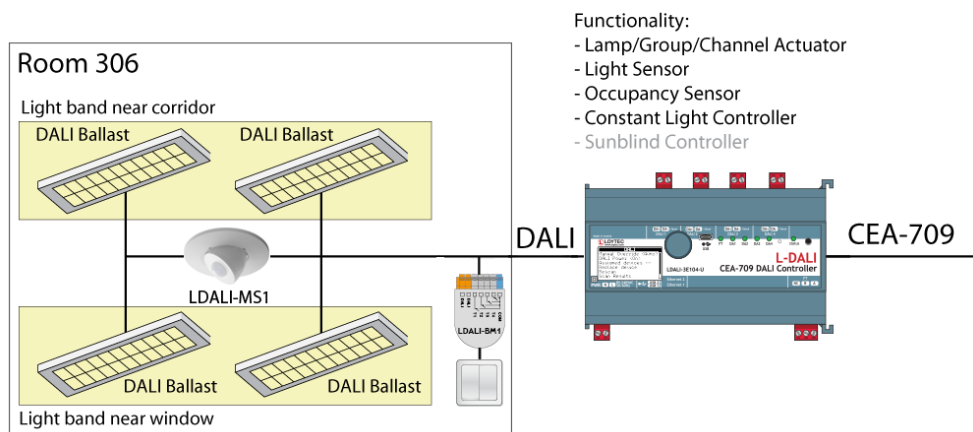

Figure 20: Quick-Start Example Project.

3.1 Hardware Installation

3.1.1 Models without built-in DALI Bus Power Supply

For models without built-in DALI bus power supply it is recommended to use the LDALI-PWR4-U or LDALI-PWR2-U power supply together with the L-DALI. Connect the L-DALI to the LDALI-PWR4-U and to the DALI network as shown in Figure 21. To allow for easy configuration it is recommended to always connect the L-DALI to the Ethernet network. More detailed instructions are given in Chapter 4.

Important: *Do not connect terminal 26 to earth ground!*

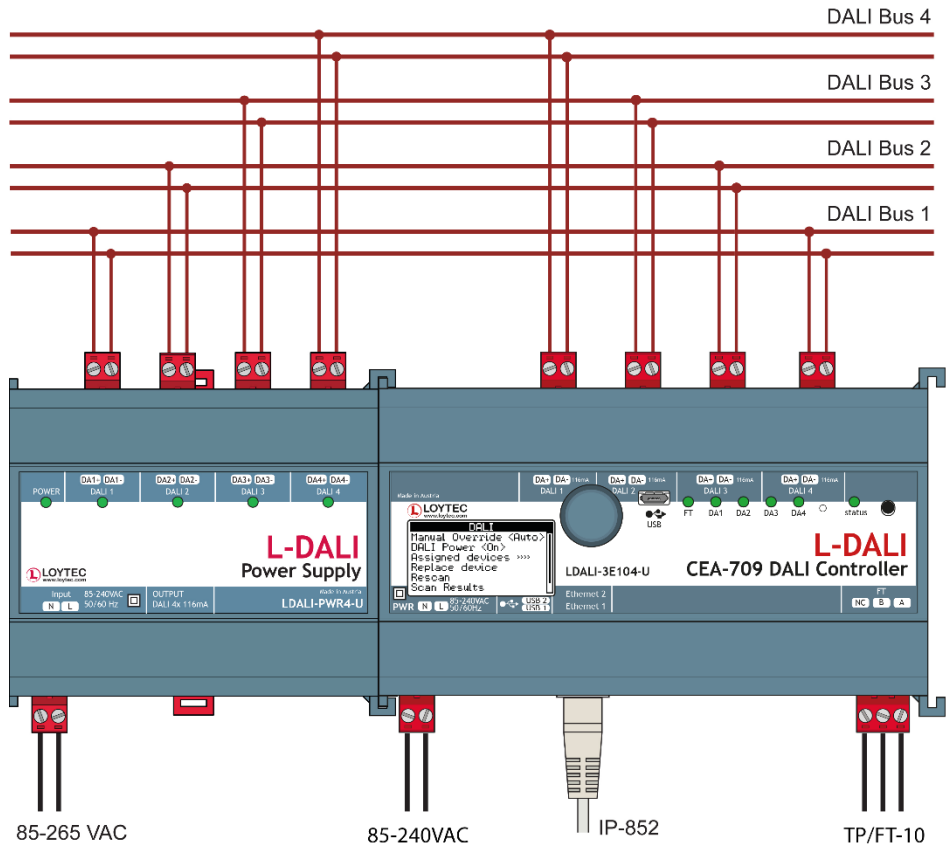

Figure 21: Basic Hardware Installation with external DALI bus power.

3.1.2 Models with built-in DALI Bus Power Supply

Connect the L-DALI to the power and to the DALI network as shown in Figure 22. To allow for easy configuration it is recommended to always connect the L-DALI to the Ethernet network (if available). More detailed instructions are given in Chapter 4.

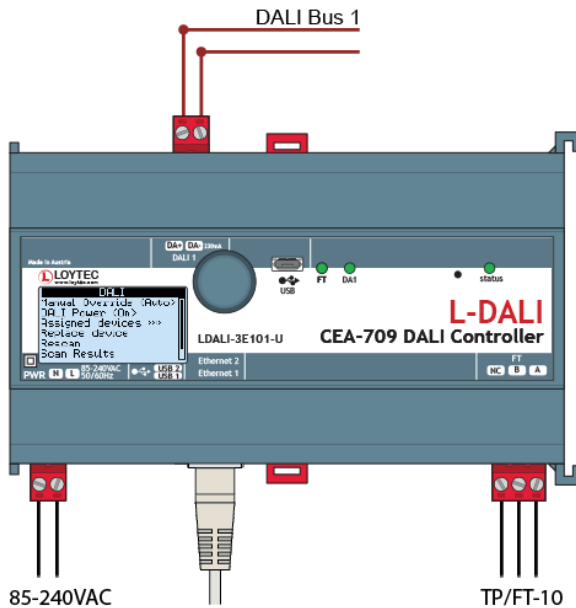

Figure 22: Basic Hardware Installation with integrated DALI bus power.

3.2 Test proper wiring of DALI devices

After the DALI ballasts have been installed and connected to the DALI network, the installation can be tested by following these steps:

3.2.1 Models without LCD display

1. Check that the DALI LEDs (“DALI x ACT”, where x is 1 to 4) do not light up red. If one of these LEDs is red, check the proper connection of the bus power supply for the corresponding channel and check the DALI wiring for short-circuits.
2. Press the DALI mode button (“ON/OFF/AUTO”) on the front panel of the L-DALI once. Now all DALI ballasts should be switched on (maximum level) and the DALI LEDs on the L-DALI should light up green.
3. Press the DALI mode button again. Now all DALI ballasts should be switched off and the DALI LEDs on the L-DALI should light up orange.
4. Press the DALI mode button again. This should not change the state of the DALI ballasts but return the L-DALI to the auto-mode (control via CEA-709/BACnet interface).

3.2.2 Models with LCD display

1. On LDALI models with only one DALI channel check that status LED does not light up red, on models with multiple DALI channels check the DALI LEDs (“DALI x ACT”, where x is 1 to 4). If the LED is red, check the DALI wiring for short-circuits. In case an external bus-power supply is used check the proper connection of the bus power supply for the corresponding channel.
2. Turn the jog dial to navigate to the DALI menu item.

```

LOYTEC LDALI-E101-U
  Unnamed Project
    192.168.3.51
# 28% 100FD
DALI >>> 100FD
Datapoints >>>
Device Settings >>>

```

3. Press down to jog dial to enter the DALI menu.

```

DALI
Channel: 1
Manual Override <Auto>
DALI Power <On>
Assigned devices >>>
Replace device >>>
Rescan >>>

```

4. On devices with multiple DALI channels select menu item “Channel” and select the DALI channel to be tested.

```

DALI
Channel: 1
Manual Override <Auto>
DALI Power <On>
Assigned devices >>>
Replace device >>>
Rescan >>>

```

5. Turn the jog dial to navigate to the menu item “Manual Override: Auto”.

```

DALI
Channel: 1
Manual Override <Auto>
DALI Power <On>
Assigned devices >>>
Replace device >>>
Rescan >>>

```

- Press down the jog dial. Then turn it one step to the right. The manual override must change to “On”.

```

DALI
Channel: 1
Manual Override <On>
DALI Power <On>
Assigned devices >>>>
Replace device >>>>
Rescan >>>>

```



Now all DALI ballasts should be switched on and the status LED on the L-DALI should light up green.

- Turning the dial one more step right the manual override must change to “Off”.

```

DALI
Channel: 1
Manual Override <Off>
DALI Power <On>
Assigned devices >>>>
Replace device >>>>
Rescan >>>>

```



Now all DALI ballasts should be switched off and the status LED on the L-DALI should light up orange.

- Turn the dial one step right once more. This should not change the state of the DALI ballasts but return the manual override back to the auto-mode (control via L-DALI light application).

```

DALI
Channel: 1
Manual Override <Auto>
DALI Power <On>
Assigned devices >>>>
Replace device >>>>
Rescan >>>>

```



3.3 Device configuration

The L-DALI can be configured via a console interface or via the Web interface. To configure the L-DALI, the following steps have to be performed:

- Setup IP configuration (see Sections 3.3).
- Setup the DALI network (see Section 3.5 or 3.6).

Note: This setup procedure assumes the use of the IP interface.

3.4 Configuration of IP Address

3.4.1 IP Configuration via the LCD Display

Device models with an LCD display can also be configured to their basic settings through jog dial navigation on the LCD UI. Turn the jog dial to navigate between menu items and press to enter a menu or go into selection mode. When in selection mode turn the jog dial to alter the value and press again to quit the selection. Some input fields provide acceleration. This means turning faster changes the value in larger increments.

To Set the IP Address on the LCD Display

- On the LCD main screen set the desired language. Navigate to the flag symbol, press the button and choose the desired language.

```

LOYTEC LDALI-E101-U
  Unnamed Project
  192.168.3.51
# 22% # ✓
DALI >>> 100FD
Datapoints >>>
Device Settings >>>

```

2. Navigate to the IP address on the main screen and press the button.

```

LOYTEC LDALI-E101-U
  Unnamed Project
  192.168.3.51
# 26% # ✓
DALI >>> 100FD
Datapoints >>>
Device Settings >>>

```

3. There navigate to the needed input fields, press and change the value. Press again to set the value. Continue to the next field.

```

TCP/IP Setup
DHCP: OFF
Addr: 192.168.003.051
Mask: 255.255.192.000
Gtwy 192.168.001.001
Save and reboot

```

4. Finally navigate to **Save and reboot** and press.
5. Acknowledge the reboot and the device reboots with the new IP address.

3.4.2 IP Configuration via the Web Interface

As an alternative to the console interface the Web interface can be used to configure the device. In a Web browser enter the default IP address 192.168.1.254 of the L-DALI. Note that if your PC has an IP address in a subnet other than 192.168.1.xxx please open a command tool and enter the following route command to add a route to the L-DALI.

To Add a Route to the Device

1. Windows **START** → **Run**
2. Enter 'cmd' and click **OK**.
3. In the command window enter the command line

```
route add 192.168.1.254 %COMPUTERNAME%
```

In Windows7 replace %COMPUTERNAME% with the PC's actual IP address.

4. Then open your Web browser and type in the default IP address 192.168.1.254.

LOYTEC **Device Info**

LDALI-3E104
2015-05-27 10:07:25

Device Info
Data
Commission
Config
Statistics
Documentation
Reset
Contact
Logout

networks under control

General Info

Product	LDALI-3E104, firmware 5.2.0	2015-05-22 16:19:45
Hostname	ldali-og3, 10.101.18.160	
Serial number	013301-800000B7618	
Free RAM, heap, flash	3897 KB, 257 KB, 1997 KB	
CPU, temp, supply	70%, 42°C, 23V	
NTP status	in-sync	
Uptime	4 days, 14:17:53	

Device Status

Warning

DALI Channel 1	27 devices online
DALI Channel 2	25 devices online
DALI Channel 3	26 devices online
DALI Channel 4	Bus supply failed

CEA-709 ✓ CEA-709

Ethernet ✓ connected 10.101.18.160
 ✓ FTP ✓ Telnet ✓ Web UI ✓ HTTP
 ✓ Global Connections (CEA-852)
 ✓ OPC XML-DA (3 clients, 2 subscriptions)

Firmware Info

	Primary (ACTIVE)	Fallback
Firmware	L-DALI Primary Image	L-DALI Fallback Image
Version	5.2.0	0.99.0
Build date	2015-05-22 16:19:45	2009-07-30 12:30:24

Project Information

Project file	20111108_LDali.ldali	<input type="checkbox"/> Remote config
Project name	L-DALI default	
Project timestamp (UTC)	2015-02-26 13:07:19	
Project status	ok	

CEA-709 application unique node IDs and program IDs

Node	NID	PID	Status	Action
CEA-709 Node 1	80 00 00 0B 76 18	90 00 D7 22 00 8A 04 02	Online	Send Service Pin
IP Node 1			inactive	
CEA-709 Node 2	80 00 00 0B 76 19	90 00 D7 22 00 8A 04 02	Online	Send Service Pin
IP Node 2			inactive	
CEA-709 Node 3	80 00 00 0B 76 1A	90 00 D7 22 00 8A 04 02	Online	Send Service Pin
IP Node 3			inactive	
CEA-709 Node 4	80 00 00 0B 76 1B	90 00 D7 22 00 8A 04 02	Offline	Send Service Pin
IP Node 4			inactive	

Figure 23: Example Start Screen.

- Click on **Config** in the left menu. You will be asked to enter the administrator password in order to change the IP settings. Enter 'loytec4u' and select **Login**.

LOYTEC **Login**

LDALI-3E104
2015-05-27 10:08:47

Device Info
Data
Commission

networks under control

Enter your username and password

Account:

Password:

Figure 24: Enter 'loytec4u' as the default administrator password.

- The Config menu opens. Click on **Port Config** in the Config menu and select **Ethernet 1 (LAN)** tab. Enter the IP address, the IP netmask, and IP gateway for this device as shown in Figure 25.
- Press **Save Settings** and then reset the device by selecting **Reset** in the highlighted text. This changes the IP settings of the device.

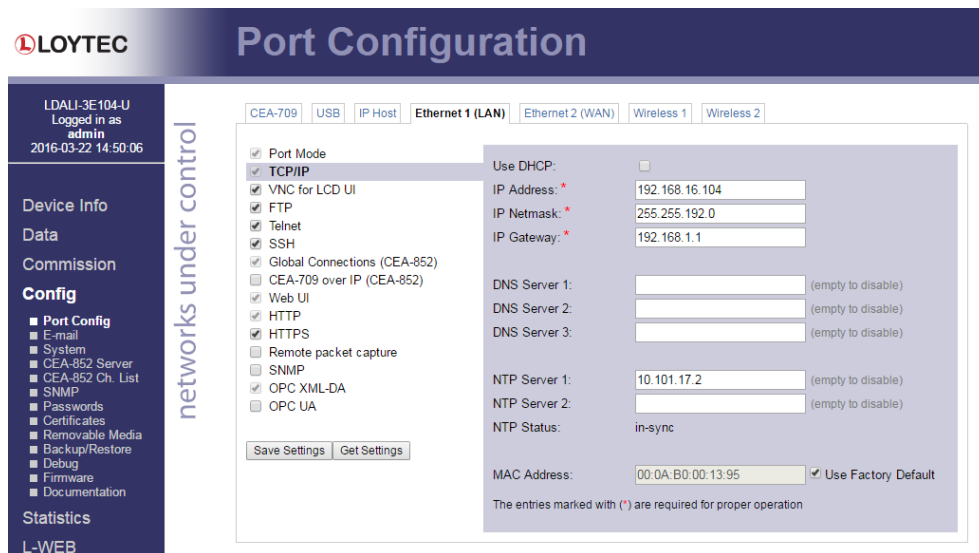

Figure 25: Enter IP address and gateway.

3.4.3 IP Configuration via Console

If your model is equipped with a console interface use a standard null-modem cable with full handshaking to connect COM1 of the PC to the Console on the device. Use a PC terminal program with the communication settings set to 38,400 bps / 8 data bits / no parity / 1 stop bit / no handshake. Power up the device or press **Return** if the device is already running. The following menu should appear on the terminal:

```
Device Main Menu
-----
[1] Show device information
[2] Serial firmware upgrade
[3] System configuration
[4] DALI maintenance
[5] IP configuration
[6] CEA-852 device configuration
[7] CEA-709 configuration
[8] Reset configuration (factory defaults)
[9] Device statistics

[a] Data Points

[0] Reset device

Please choose:
```

Figure 26: Device Main Menu.

Select '5' from the device main menu and enter the IP address, netmask, and gateway address. Note that you must use different IP addresses if you are using multiple IP devices in your setup.

IP Configuration Menu

```

[1] DHCP          : disabled
[2] IP Address    : 192.168.1.254
[3] IP Netmask   : 255.255.255.0
[4] IP Gateway   : 192.168.1.1
[5] Hostname     : new
[6] Domainname  : <unset>
[7] DNS Servers  : <unset>
[9] MAC Address  : 00:0A:B0:01:0C:9F (factory default)
[0] NTP Servers  : <unset> (out-of-sync)
[b] Link Speed & Duplex : Auto Detect

[q] Quit without saving
[x] Exit and save

```

Please choose:

Figure 27: Enter basic IP settings.

Press ‘x’ to save the IP settings and reset the device with the main menu item ‘0’ in order to let the new IP settings take effect.

Important!

The default IP address 192.168.1.254 is only set for configuration access. It must be changed in order to make the device functional.

3.5 Configuration with PC Software

For the LDALI product family a PC based configuration software – the LINX Configurator – is available. As an alternative the web interface can be used for configuration (see Section 3.6).

Install the LINX Configurator software from the setup.exe. This file can be downloaded from www.loytec.com. This tool can be used as a stand-alone tool or as LNS plug-in. In this example we will use the LINX Configurator software as a stand-alone tool.

A detailed description of the LINX Configurator configuration software can be found in the LINX Configurator User Manual [2].

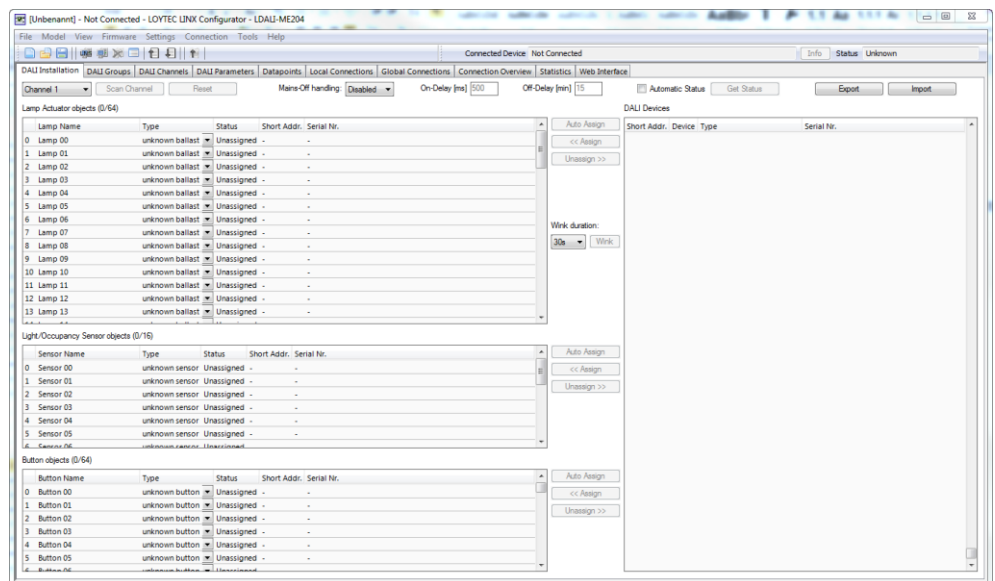

Figure 28: LINX Configurator software, Start.

3.5.1 Connect to Device in Stand-Alone Mode

1. Select the IP connection method by clicking on the **Connect to device** button in the tool bar as shown in Figure 29.

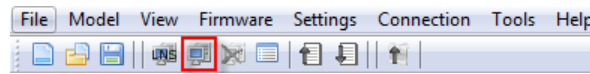

Figure 29: LINX Configurator software, Connect to device

2. In the Connection dialog (see Figure 30) choose connection type “Web Service”, enter the IP address or hostname of the L-DALI and the devices “admin” password. The default “admin” password is ‘loytec4u’ (older firmware versions used ‘admin’).
3. Optionally, click on **New** and enter a user-defined name for this connection. That name can be selected later to connect. Click on **Save** to store that connection.
4. Click on **Connect**. This establishes the connection to the device.
5. The LINX Configurator software asks if you want to upload the current configuration of the device. You can cancel this dialog because in this quick-start we configure the device from scratch.

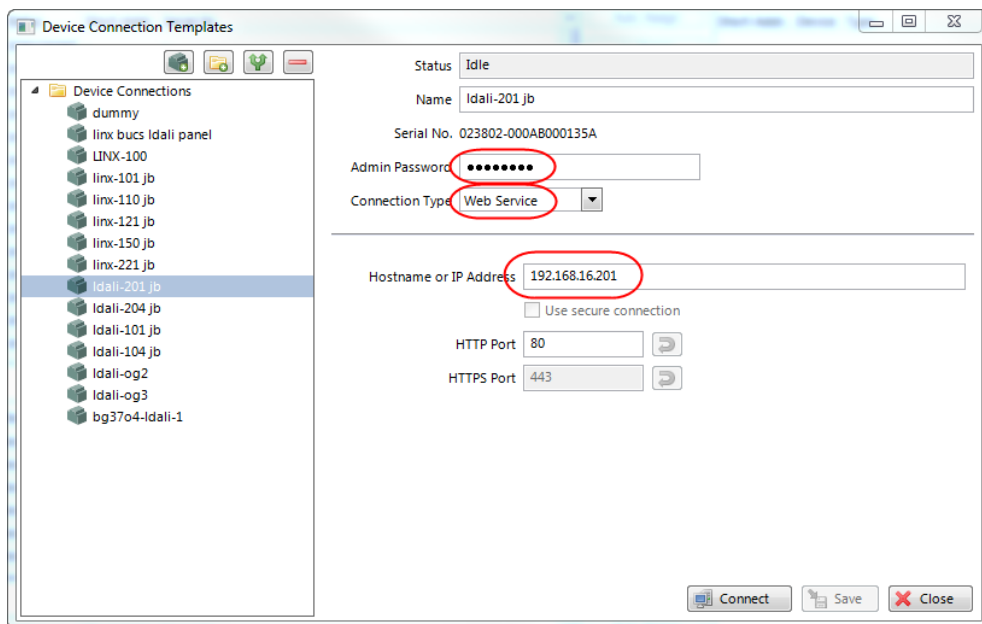

Figure 30: LINX Configurator software, Connection Dialog.

3.5.2 Scan DALI Channel

1. Change to the **DALI Installation** tab.
2. Select the DALI channel and click on the **Scan Channel** button shown in Figure 31.

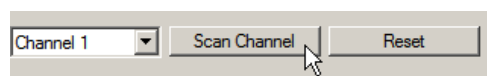

Figure 31: LINX Configurator software, scan DALI Channel.

- The L-DALI device scans the selected channel and displays all detected devices as shown in Figure 32. In case an error occurs see the LOYTEC Device User Manual [1] for a description of the error codes and possible reasons.

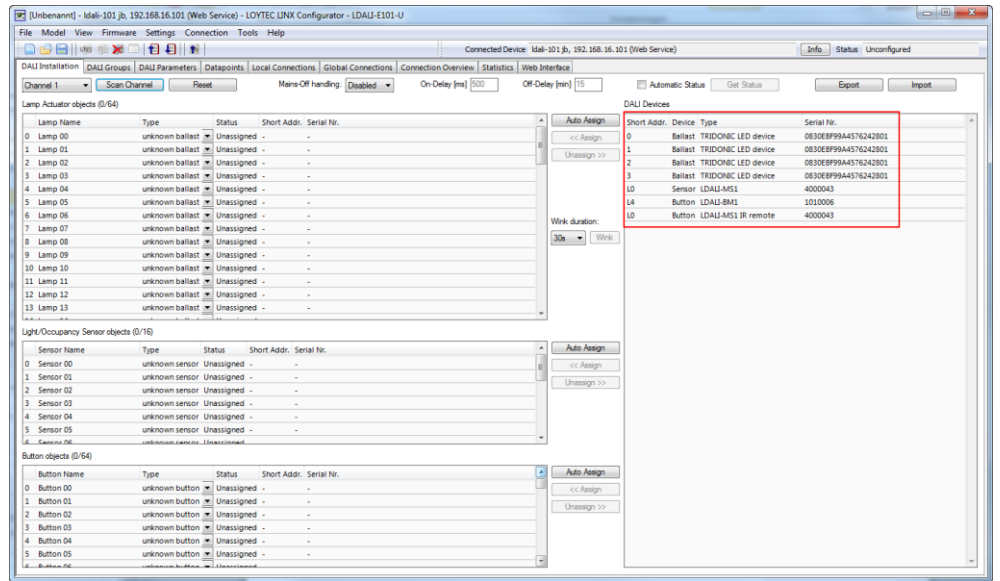

Figure 32: LINX Configurator software, detected DALI devices.

3.5.3 Assign Lamps, Sensor and Button to LONMARK/BACnet Objects

- To identify which of the four detected DALI ballasts is which physical lamp, select one and click the **Wink** button. The corresponding lamp blinks for the configured wink duration.

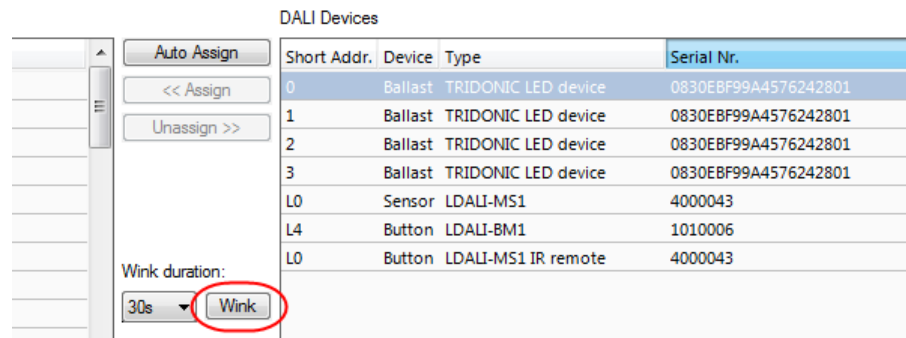

Figure 33: LINX Configurator software, Wink button.

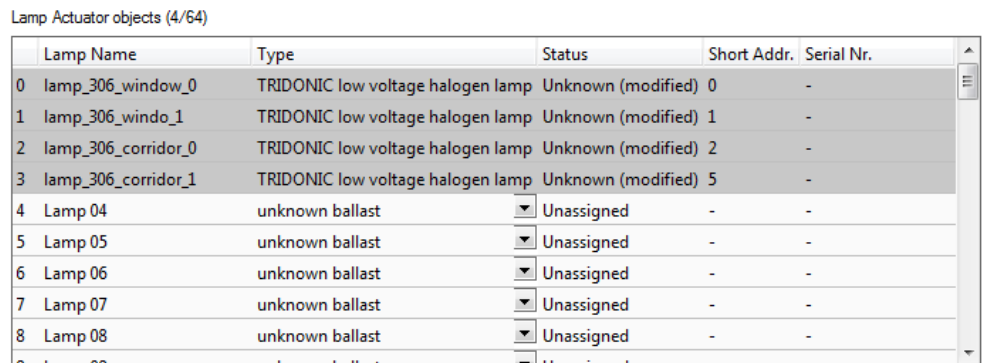

Figure 34: LINX Configurator software, assigned Lamp Actuator objects.

- To assign a DALI ballast to an object, select the ballast in the list of **DALI Devices** and drag it to the desired position in the **Lamp Actuator objects** list on the left side. You can change the names of the lamp actuator objects. After you have assigned all lamps and changed the names the configuration should look as shown in Figure 34.
- To assign the DALI multi-sensor to an object, select the sensor in the list of **DALI Devices** and drag it to the desired position in the **Light/Occupancy Sensor objects** list on the lower left side. After you have changed the names of the sensor object the configuration should look as shown in Figure 35.

Light/Occupancy Sensor objects (1/16)

	Sensor Name	Type	Status	Short Addr.	Serial Nr.
0	sensor_room_306	LDALI-MS1	Unknown (modified)	L0	4000043
1	Sensor 01	unknown sensor	Unassigned	-	-
2	Sensor 02	unknown sensor	Unassigned	-	-
3	Sensor 03	unknown sensor	Unassigned	-	-
4	Sensor 04	unknown sensor	Unassigned	-	-
5	Sensor 05	unknown sensor	Unassigned	-	-

Figure 35: LINX Configurator software, Assigned Light/Occupancy Sensor Object.

- Similar, assign the DALI button by dragging it to the desired position in the **Button objects** list.

3.5.4 Grouping Lamps

Lamps which are assigned to a group can be controlled together by the corresponding group object. We will create three groups: One for the lamps near the window, one for the lamps near the corridor and one for all lamps in the room.

- In the LINX Configurator software switch to the **DALI Groups** tab.
- Add the two lamps near the window to group 0, the two lamps near the corridor to group 1 and add all lamps in the room to group 2. Assign names to the groups as shown in Figure 36.

DALI Installation | DALI Groups | DALI Parameters | Datapoints | Local Connections | Global Connections | Connection Overview | Statistics | Web Interface

Channel 1 Recover group information from devices

Group Assignment

	0	1	2	3	4	5	6
Lamp Name/Group Name	room_306_window	room_306_corrid...	room_306	Group 03	Group 04	Group 05	Group
0 lamp_306_window_0	<input checked="" type="checkbox"/>	<input type="checkbox"/>	<input type="checkbox"/>	<input type="checkbox"/>	<input type="checkbox"/>	<input type="checkbox"/>	<input type="checkbox"/>
1 lamp_306_window_1	<input checked="" type="checkbox"/>	<input type="checkbox"/>	<input type="checkbox"/>	<input type="checkbox"/>	<input type="checkbox"/>	<input type="checkbox"/>	<input type="checkbox"/>
2 lamp_306_corridor_0	<input type="checkbox"/>	<input checked="" type="checkbox"/>	<input checked="" type="checkbox"/>	<input type="checkbox"/>	<input type="checkbox"/>	<input type="checkbox"/>	<input type="checkbox"/>
3 lamp_306_corridor_1	<input type="checkbox"/>	<input checked="" type="checkbox"/>	<input checked="" type="checkbox"/>	<input type="checkbox"/>	<input type="checkbox"/>	<input type="checkbox"/>	<input type="checkbox"/>
4 Lamp 04	<input type="checkbox"/>	<input type="checkbox"/>	<input type="checkbox"/>	<input type="checkbox"/>	<input type="checkbox"/>	<input type="checkbox"/>	<input type="checkbox"/>
5 Lamp 05	<input type="checkbox"/>	<input type="checkbox"/>	<input type="checkbox"/>	<input type="checkbox"/>	<input type="checkbox"/>	<input type="checkbox"/>	<input type="checkbox"/>
6 Lamp 06	<input type="checkbox"/>	<input type="checkbox"/>	<input type="checkbox"/>	<input type="checkbox"/>	<input type="checkbox"/>	<input type="checkbox"/>	<input type="checkbox"/>
7 Lamp 07	<input type="checkbox"/>	<input type="checkbox"/>	<input type="checkbox"/>	<input type="checkbox"/>	<input type="checkbox"/>	<input type="checkbox"/>	<input type="checkbox"/>
8 Lamp 08	<input type="checkbox"/>	<input type="checkbox"/>	<input type="checkbox"/>	<input type="checkbox"/>	<input type="checkbox"/>	<input type="checkbox"/>	<input type="checkbox"/>
9 Lamp 09	<input type="checkbox"/>	<input type="checkbox"/>	<input type="checkbox"/>	<input type="checkbox"/>	<input type="checkbox"/>	<input type="checkbox"/>	<input type="checkbox"/>
10 Lamp 10	<input type="checkbox"/>	<input type="checkbox"/>	<input type="checkbox"/>	<input type="checkbox"/>	<input type="checkbox"/>	<input type="checkbox"/>	<input type="checkbox"/>
11 Lamp 11	<input type="checkbox"/>	<input type="checkbox"/>	<input type="checkbox"/>	<input type="checkbox"/>	<input type="checkbox"/>	<input type="checkbox"/>	<input type="checkbox"/>
12 Lamp 12	<input type="checkbox"/>	<input type="checkbox"/>	<input type="checkbox"/>	<input type="checkbox"/>	<input type="checkbox"/>	<input type="checkbox"/>	<input type="checkbox"/>

Figure 36: LINX Configurator software, DALI group configuration.

3.5.5 Parameterize the Constant Light Controller

- In the LINX Configurator software switch to the **DALI Parameters** tab.
- Select the constant light controller with index 0 as shown in Figure 37. The parameters of the selected constant light controller are displayed in the middle of the window (1).

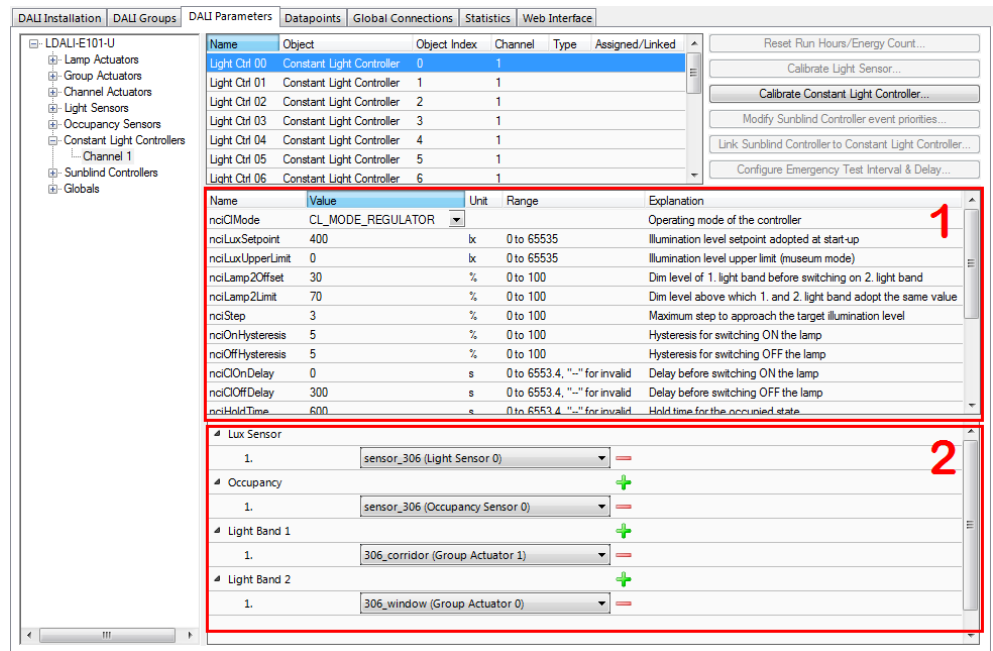



Figure 37: Parameterize Constant Light Controller.

- Change the parameter *nciClMode* to `CL_MODE_REGULATOR`. This parameter selects the operating mode. The `REGULATOR` mode is used if a light/occupancy sensor is installed which measures the indoor illumination.
- Change the setpoint of the constant light controller (*nciLuxSetpoint*) to the desired light level (e.g. 400 lux).
- You can leave the default values for the remaining parameters. For a description of the constant light controller functionality and the parameters refer to Section 6.1.4.
- Determine which sensors (occupancy & lux) are used as inputs to the constant light controller instance and which groups are controlled in the lower part of the window (2).
- Click on the  to add an input or output. Use the drop down box to select a sensor (input) or a light group (output). In our example we use “sensor_306” for lux and occupancy sensor inputs, group “306_corridor” as output of the first (brighter) light band and group “306_window” as output for the second (darker) light band.

3.5.6 Parameterize the DALI button

- Stay on the **DALI Parameters** tab and select the button object to which you have assigned your DALI button as shown in Figure 38.

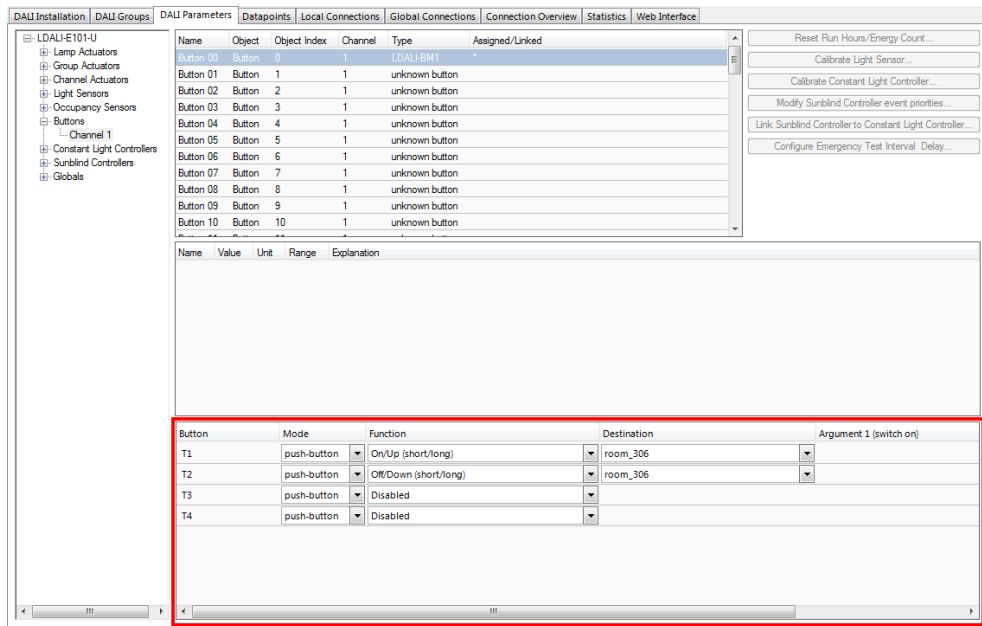

Figure 38: Parameterize DALI button functions.

- Determine which function is executed and which group is controlled by which button input in the lower part of the window. In our example we use button T1 for “On/Up” and T2 for “Off/Down”, both controlling group “room_306”. This will allow us to control all lights in the room together.

3.5.7 Download Configuration

- To download the configuration into the L-DALI device click on the **Download Configuration** button in the toolbar.

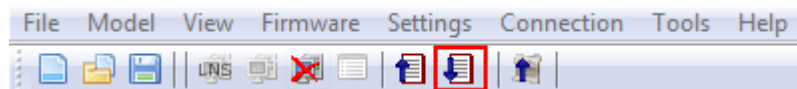

Figure 39: LINX Configurator software, Download Configuration.

- Because we have changed only the DALI configuration and the parameters it is sufficient to check only DALI Configuration and Parameters in the following dialog. This speeds up the download process.

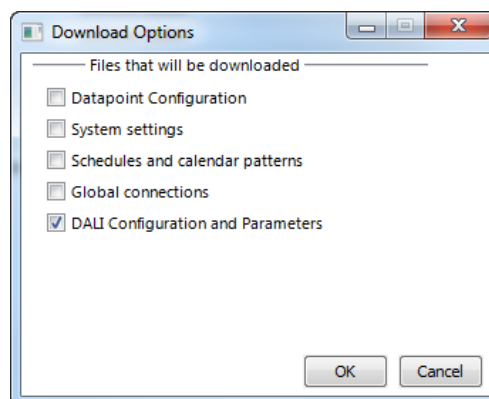

Figure 40: LINX Configurator software, Download DALI Configuration and Parameters.

- After the download is complete, go back to the DALI Installation tab and press the **Get Status** button. Now the assigned DALI devices are displayed on a green background (see Figure 41). The green background color indicates that the communication with the device is OK. If there is a communication error, the device will be displayed with a red background color.

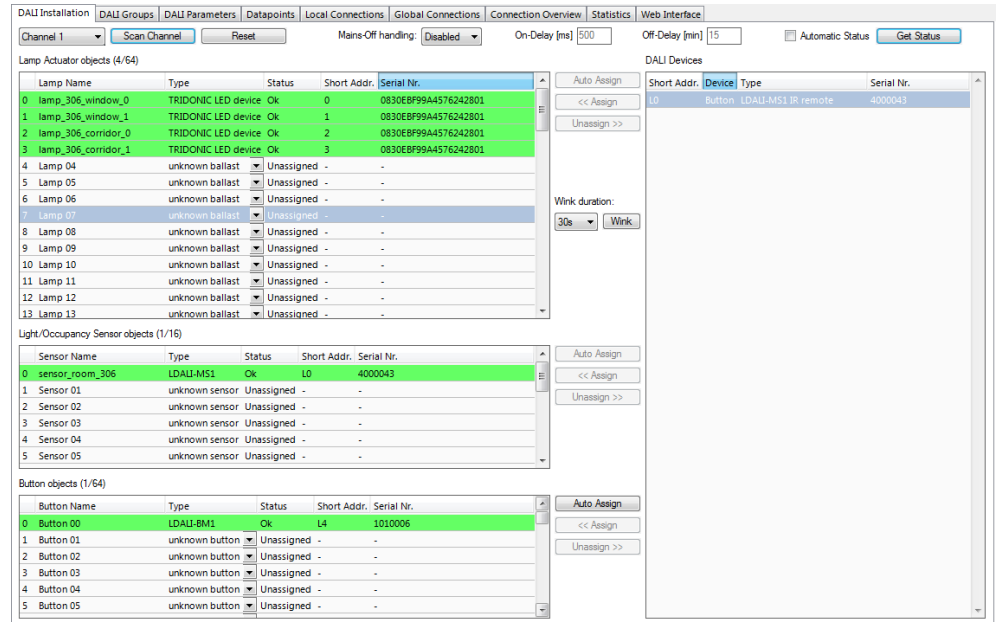

Figure 41: LINX Configurator software, After Configuration Download.

3.5.8 Calibrate Light Sensor

The L-DALI device allows calibrating the light sensor under up to seven different light conditions to counter any non-linearity of the sensor. However, in many cases it is enough to calibrate the sensor with a single light condition which is near the setpoint. In this quick-start only one lux measurement is performed.

- In the LINX Configurator software switch to the **Parameters** tab.
- Select the light sensor index 0 and click on the **Calibrate Light Sensor...** button as shown in Figure 42. The light sensor calibration window as shown in Figure 43 is displayed.

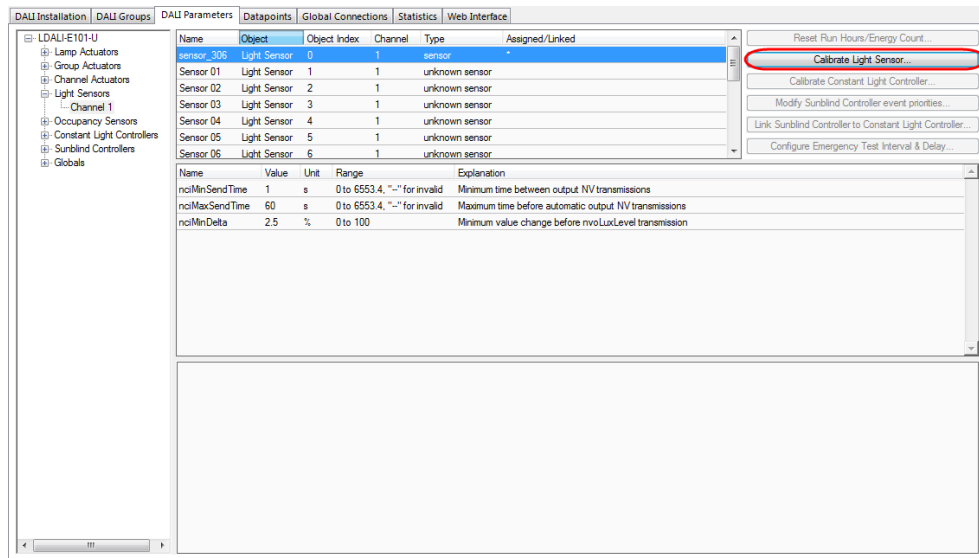

Figure 42: Parameterize Light Sensor.

3. Measure the current lux level at the reference area (e.g. desk) using a luxmeter.
4. Enter the measured lux level in the input field and select the index 0.
5. Press the **Calibrate** button.
6. Close the dialog by pressing the **Done** button.

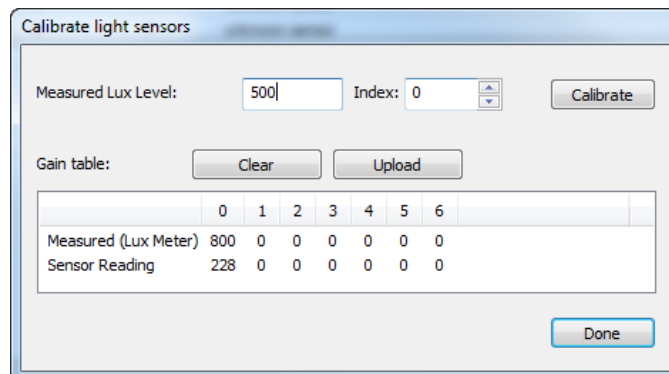

Figure 43: Calibrate Light Sensor.

3.6 Configuration using Web Interface

As an alternative to the LINX Configurator PC Software the Web interface of the L-DALI can be used. In a Web browser enter the IP address as set up in Section 3.4.

A detailed description of the L-DALI Web interface can be found in the LOYTEC Device User Manual [1].

3.6.1 Scan DALI Channel

1. In the L-DALI Web interface click on **Commission** in the left menu. If not already logged in you will be asked to enter the administrator password. Enter 'loytec4u' and select **Login**.

- The Commission menu opens. Click on **DALI Installation** in the Commission menu. The DALI installation page opens as shown in Figure 44.

Channel 1 Channel 2 Channel 3 Channel 4

Wink Duration: 30 sec Mains-Off handling: Disabled Mains-On delay: 500 ms Mains-Off delay: 0 min DALI Power: Off Save

Devices in Database

Reload Reset Action on Selected Execute

Name	Type	Nom. Pwr	Status	Short Addr.	Serial Number
no devices found					

Scanned Devices not in Database

Scan Clear Results Save Assignment Auto Assign

Name	Short Addr.	Type	Serial Nr.
no devices found			

Unassigned Devices

Search

Name	Type	Serial Nr.
no devices found		

Figure 44: DALI Installation Web Interface: Initial view.

- If the device supports more than one DALI channel select the DALI channel by clicking on the different tabs at the top of the page labeled **Channel 1**, **Channel 2**, etc. and press the **Scan** button.

Wink Duration: 30 sec Mains-Off handling: Disabled Mains-On delay: 500 ms Mains-Off delay: 15 min DALI Power: On Save

Devices in Database

Reload Reset Action on Selected Execute

Name	Type	Nom. Pwr	Status	Short Addr.	Serial Number
no devices found					

Scanned Devices not in Database

Scan Clear Results Save Assignment Auto Assign

Name	Short Addr.	Type	Serial Nr.	
Lamps				
UNASSIGNED	00	LED device	0830EBF99A4576242801	Wink
UNASSIGNED	01	LED device	0830EBF99A4576242801	Wink
UNASSIGNED	02	LED device	0830EBF99A4576242801	Wink
UNASSIGNED	03	LED device	0830EBF99A4576242801	Wink
Sensors				
UNASSIGNED	L00	LDALI-MS1	4000043	Wink
Buttons				
UNASSIGNED	L00	LDALI-BM1	1010006	
UNASSIGNED	L00	LDALI-MS1 IRT	4000043	Wink

Unassigned Devices

Search

Name	Type	Serial Nr.
no devices found		

Figure 45: DALI Installation Web Interface: Detected DALI devices.

- The L-DALI scans the DALI channel and lists the detected devices under **Scanned Devices not in Database** in the lower half of the Web interface (see Figure 45). In case an error occurs see the LOYTEC Device User Manual [1] for a description of the error codes and possible reasons.

3.6.2 Assign Lamps, Sensor and Button to LONMARK/BACnet Objects

- To identify which of the four detected DALI ballasts is which physical lamp, select one and click the **Wink** button. The corresponding lamp blinks for the configured wink duration.
- To assign a DALI device to a LONMARK or BACnet object, use the drop-down list available for each device in the **Scanned Devices not in Database** section (left column). This list contains all available fieldbus objects. When you are done, press the button **Save Assignment**. Alternatively to manual assignment press the button **Auto Assign** for random assignment. After you have assigned all lamps the configuration should look as shown in Figure 46.

Wink Duration: 30 sec | Mains-Off handling: Disabled | Mains-On delay: 500 ms | Mains-Off delay: 15 min | DALI Power: On | Save

Devices in Database

Reload | Reset | Action on Selected: [v] | Execute

Name	Type	Nom. Pwr	Status	Short Addr.	Serial Number	
Lamps						
0 Lamp_1_00	LED device	0 W	OK: 0%	00	0830EBF99A4576242801	Wink On Off
1 Lamp_1_01	LED device	0 W	OK: 0%	01	0830EBF99A4576242801	Wink On Off
2 Lamp_1_02	LED device	0 W	OK: 0%	02	0830EBF99A4576242801	Wink On Off
3 Lamp_1_03	LED device	0 W	OK: 100%	03	0830EBF99A4576242801	Wink On Off
Sensors						
0 Sensor_1_00	LDALI-MS1	-	OK: 64 lux unoccupied	L00	4000043	Wink Calibrate
Buttons						
0 Button_1_00	LDALI-BM1	-	OK: -	L00	1010006	Configure

Scanned Devices not in Database

Scan | Clear Results | Save Assignment | Auto Assign

Name	Short Addr.	Type	Serial Nr.
rescan necessary			

Unassigned Devices

Search

Name	Type	Serial Nr.
no devices found		

Figure 46: DALI Installation Web Interface: Device assignment done.

3.6.3 Grouping Lamps

Lamps which are assigned to a group can be controlled together by the corresponding LONMARK or BACnet group object. We will create two groups: One for the lamps near the window and one for the lamps near the corridor.

- Click on **DALI Groups** in the Config menu. The DALI Groups page opens.
- Again, selected the DALI channel by clicking on the different tabs at the top of the page labeled **Channel 1**, **Channel 2**, etc.
- Add the two lamps near the window to group 0, the two lamps near the corridor to group 1 and all lamps to group 2 by checking the corresponding check boxes. Press the **Save** button. The result will look like in Figure 47.

networks under control

LOYTEC DALI Groups

LDALI-ME204
Logged in as admin
2015-05-27 11:09:23

Device Info
Data
Commission
■ BACnet
■ CLC Bindings
■ DALI Groups
■ DALI Installation
■ DALI Scene
Config
Statistics
Documentation
Reset

Channel 1 Channel 2 Channel 3 Channel 4

Save Reload

#	0	1	2	3	4	5	6	7	8	9	10	11	12	13	14	15
Group	Group 00	Group 01	Group 02	Group 03	Group 04	Group 05	Group 06	Group 07	Group 08	Group 09	Group 10	Group 11	Group 12	Group 13	Group 14	Group 15
On/Off	<input type="checkbox"/>	<input type="checkbox"/>	<input type="checkbox"/>	<input type="checkbox"/>	<input type="checkbox"/>	<input type="checkbox"/>	<input type="checkbox"/>	<input type="checkbox"/>	<input type="checkbox"/>	<input type="checkbox"/>	<input type="checkbox"/>	<input type="checkbox"/>	<input type="checkbox"/>	<input type="checkbox"/>	<input type="checkbox"/>	<input type="checkbox"/>
Override	-	0	-	-	-	-	-	-	-	-	-	-	-	-	-	-
Feedback	0	0	0	0	0	0	0	0	0	0	0	0	0	0	0	0
Lamp 00	<input checked="" type="checkbox"/>	<input type="checkbox"/>	<input checked="" type="checkbox"/>	<input type="checkbox"/>	<input type="checkbox"/>	<input type="checkbox"/>	<input type="checkbox"/>	<input type="checkbox"/>	<input type="checkbox"/>	<input type="checkbox"/>	<input type="checkbox"/>	<input type="checkbox"/>	<input type="checkbox"/>	<input type="checkbox"/>	<input type="checkbox"/>	<input type="checkbox"/>
Lamp 01	<input checked="" type="checkbox"/>	<input type="checkbox"/>	<input checked="" type="checkbox"/>	<input type="checkbox"/>	<input type="checkbox"/>	<input type="checkbox"/>	<input type="checkbox"/>	<input type="checkbox"/>	<input type="checkbox"/>	<input type="checkbox"/>	<input type="checkbox"/>	<input type="checkbox"/>	<input type="checkbox"/>	<input type="checkbox"/>	<input type="checkbox"/>	<input type="checkbox"/>
Lamp 02	<input type="checkbox"/>	<input checked="" type="checkbox"/>	<input checked="" type="checkbox"/>	<input type="checkbox"/>	<input type="checkbox"/>	<input type="checkbox"/>	<input type="checkbox"/>	<input type="checkbox"/>	<input type="checkbox"/>	<input type="checkbox"/>	<input type="checkbox"/>	<input type="checkbox"/>	<input type="checkbox"/>	<input type="checkbox"/>	<input type="checkbox"/>	<input type="checkbox"/>
Lamp 03	<input type="checkbox"/>	<input checked="" type="checkbox"/>	<input checked="" type="checkbox"/>	<input type="checkbox"/>	<input type="checkbox"/>	<input type="checkbox"/>	<input type="checkbox"/>	<input type="checkbox"/>	<input type="checkbox"/>	<input type="checkbox"/>	<input type="checkbox"/>	<input type="checkbox"/>	<input type="checkbox"/>	<input type="checkbox"/>	<input type="checkbox"/>	<input type="checkbox"/>

Save Reload

Figure 47: DALI Installation Web Interface: Group Configuration.

- To test the group assignment, lights can be switched on and off by clicking on the bulb below the group name. Similar entering a value in the override row will dim the corresponding group. Entering – in the field will relinquish an active override.

3.6.4 Calibrate Light Sensor

The L-DALI device allows calibrating the light sensor under up to seven different light conditions to counter any non-linearity of the sensor. However, in many cases it is enough to calibrate the sensor with a single light condition which is near the setpoint. In this quick-start only one lux measurement is performed.

- Go to the DALI Installation page and press the **Calibrate** button next to the sensor that is to be calibrated. The DALI sensor calibration page is shown in Figure 48.

← back Sensor: 'Sensor_1_00' Level: 108 lux

Measure the current lux value and select the index in the gain table to store the measurement.

Dim lights: Group_1_00 Level: 100 % Set Auto

Measured lux level: Index: 0 Calibrate

Clear gain table Import Export

Gain table	0	1	2	3	4	5	6
Measured (lux meter)	100	0	0	0	0	0	0
Sensor reading	1196	0	0	0	0	0	0

Copy to selected
→ No sensors available

Figure 48: DALI Installation Web Interface: Sensor Calibration.

- Measure the current lux level at the reference area (e.g. desk) using a luxmeter.

3. If possible dim artificial light in room until luxmeter show desired lux setpoint. To dim the light select the rooms DALI group in the **Dim lights** drop down box, enter a desired dim value in the field **Level** and press the **Set** button.
4. Enter the measured lux level in the input field and select index 0.
5. Press the **Calibrate** button.

3.6.5 Parameterize the DALI button

1. On the **Buttons** page, stay on the **DALI** tab (see Figure 49) and click on the **Configure** button next to the button device that is to be configured. The dialog shown in Figure 50 appears.

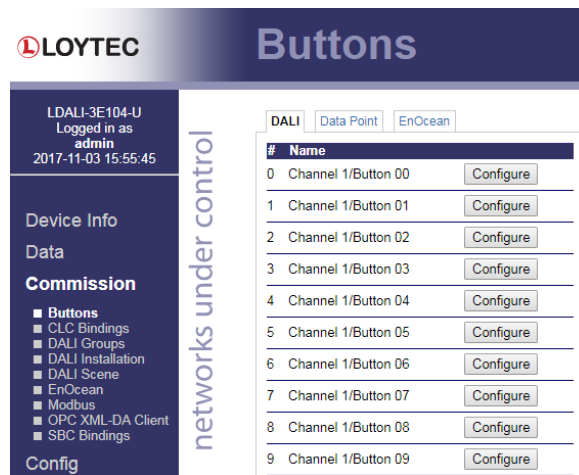

Figure 49: Button Functions.

2. Use the drop-down boxes to determine which function is executed and which group is controlled by which button input. In our example we use button T1 for “On/Up” and T2 for “Off/Down”, both controlling group 2. This will allow us to control all lights in the room together.

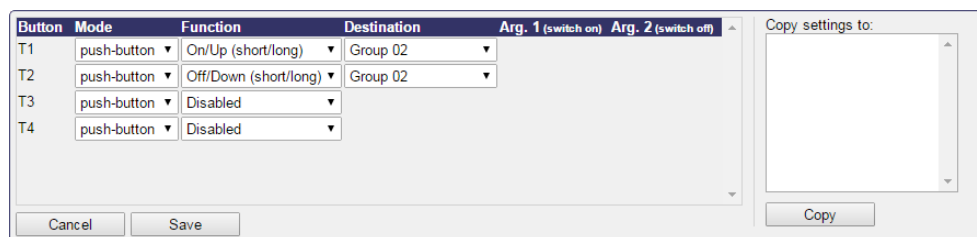

Figure 50: Configure DALI button functions.

3. Click on **Save** to write the configuration to the button device.

3.6.6 Parameterize the Constant Light Controller

1. Go to the **Data Points** page and select the data point path of constant light controller application instance 0.

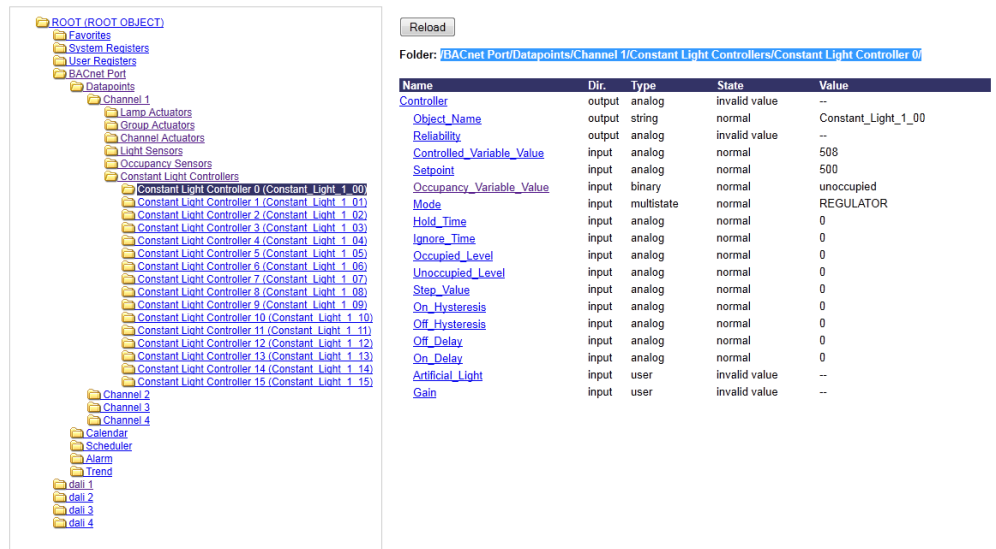

Figure 51: DALI Installation Web Interface: Parameters.

BACnet L-DALI: /BACnet Port/Datapoints/Channel 1/Constant Light Controllers/Constant Light Controller 0/

CEA-709 L-DALI: /CEA709 DALI Channel 1/Datapoints/Constant Light Controllers/Constant Light Controller 0/

The page will look like in Figure 51.

- The parameters of the selected constant light controller are displayed on the right side. Change the constant light controller mode (parameter *nciClMode* or *Mode*) to REGULATOR. This parameter selects the operating mode. The REGULATOR mode is used if a light/occupancy sensor is installed which measures the indoor illumination.

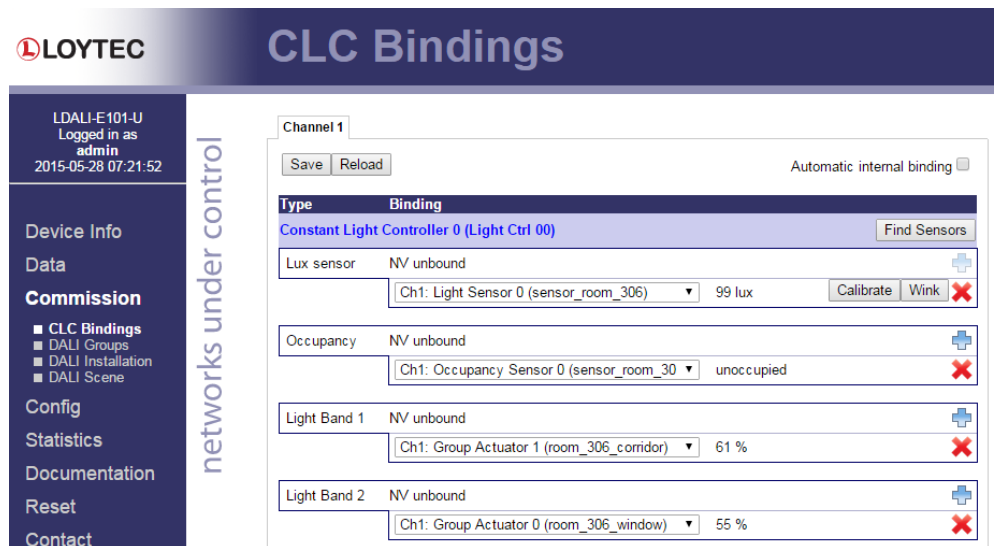

Figure 52: DALI Installation Web Interface: CLC Bindings.

- Change the setpoint of the constant light controller (parameter *nciLuxSetpoint* or *Setpoint*) to the desired light level (e.g. 400 lux).

4. You can leave the default values for the remaining parameters. For a description of the constant light controller functionality and the parameters refer to Section 6.1.4 (CEA-709) and 6.2.4 (BACnet).
5. To determine which sensors (occupancy & lux) are used as inputs to and which light groups are controlled by a constant light controller instance go to the **CLC Bindings** page (see Figure 52).
6. Again, selected the DALI channel by clicking on the different tabs at the top of the page labeled **Channel 1**, **Channel 2**, etc.
7. Click on the **Add** to add an input or output. Use the drop down box to select a sensor (input) or a light group (output). In our example we use “sensor_306” for lux and occupancy sensor inputs, group “306_corridor” as output of the first (brighter) light band and group “306_window” as output for the second (darker) light band.

3.7 Configuration of BACnet Interface (LDALI-20X only)

3.7.1 Configure BACnet Interface

To allow integrating the L-DALI to a BACnet network a network wide unique device ID and device name must be configured. This is best done using the web interface:

1. Similar to the configuration of the IP address connect to the L-DALI using your Internet browser.
2. Click on **Config** and then **BACnet Config** in the left menu.

The screenshot displays the 'BACnet Configuration' web interface. On the left, a sidebar shows the user 'admin' logged in at '2015-05-28 07:23:25'. The navigation menu includes 'Device Info', 'Data', 'Commission', and 'Config'. Under 'Config', 'BACnet' is selected. The main area shows configuration options for a BACnet device. The 'Device' tab is active, showing fields for Device ID (86), Device name (LDALI-ME204), Device description (LDALI-ME204), Device location (unknown), APDU timeout (10 s), APDU segment timeout (5 s), APDU retry count (3), and APDU length accepted (1476). A red note indicates that these settings must be unique on the network. 'Save Settings' and 'Get Settings' buttons are located at the bottom of the configuration area.

Figure 53: BACnet Device Configuration.

3. Enter a unique device ID and device name as shown in Figure 53.

For further details see the LOYTEC Device User Manual [1].

4 Hardware Installation

4.1 Enclosure

4.1.1 LDALI-3E10X-U and LDALI-ME20X-U

The LDALI-3E10X-U and LDALI-ME20X-U enclosure is 159 mm wide for DIN rail mounting, following DIN 43 880 (see Figure 54).

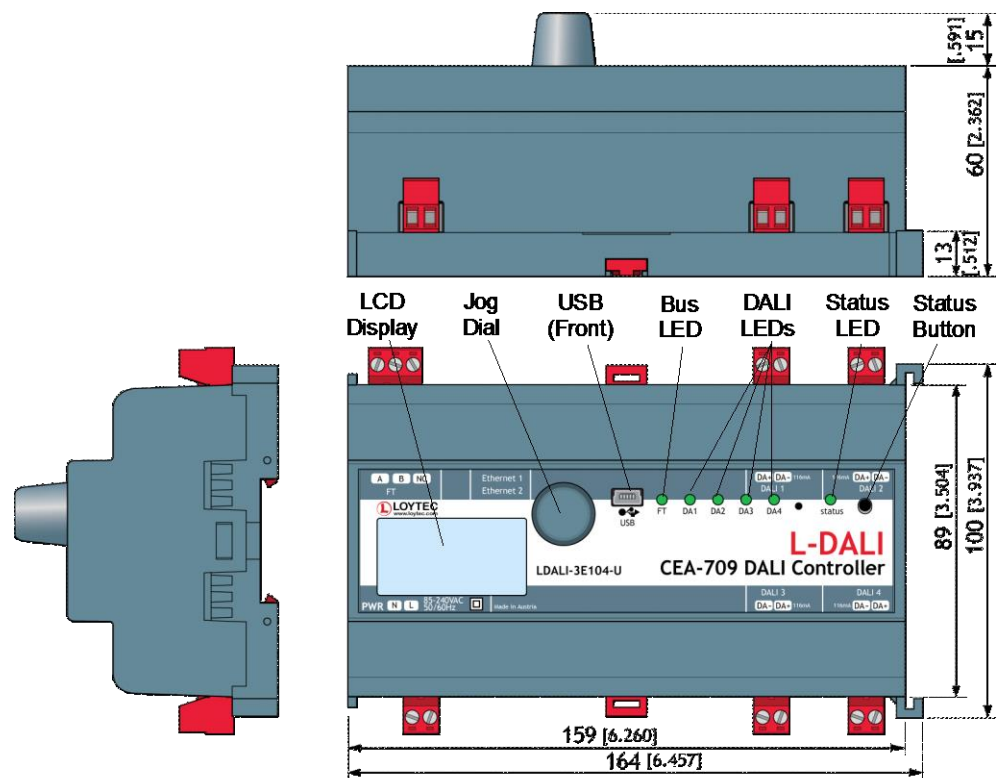

Figure 54: LDALI-3E10X-U and LDALI-ME204-U Enclosure (dimensions in mm [inch]).

4.1.2 LDALI-E101-U, LDALI-3101-U and LDALI-E101-U

The LDALI E101 U, LDALI 3101 U and LDALI E101 U enclosure is 107 mm wide for DIN rail mounting, following DIN 43 880 (see Figure 55).

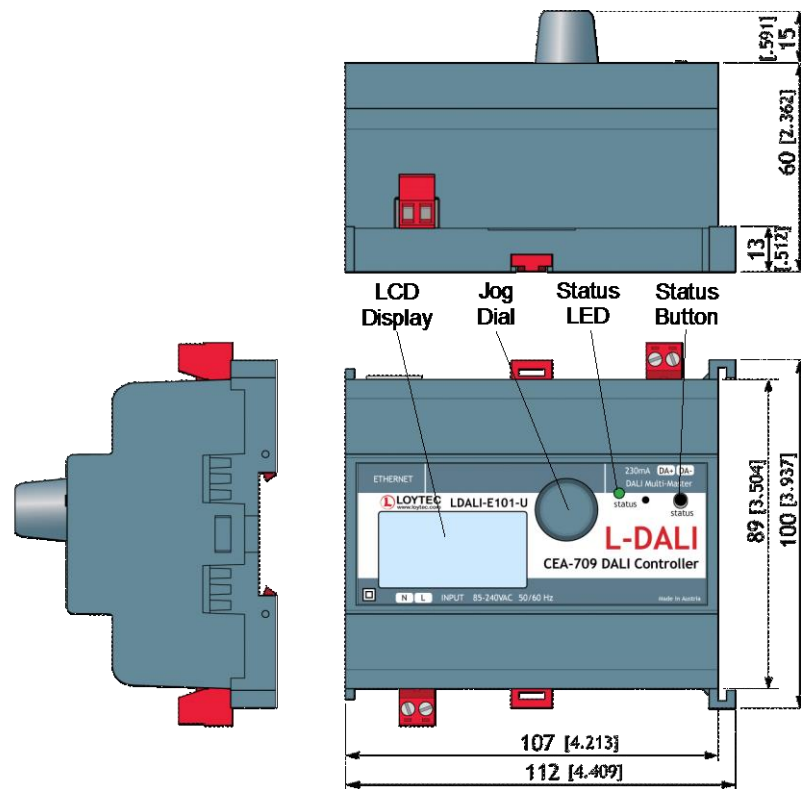

Figure 55: LDALI-E101-U, LDALI-3101-U and LDALI-E101-U Enclosure (dimensions in mm [inch]).

4.1.3 LDALI-3E10X and LDALI-ME204

The LDALI-3E10X and LDALI-ME204 enclosure is 159 mm wide for DIN rail mounting, following DIN 43 880 (see Figure 56).

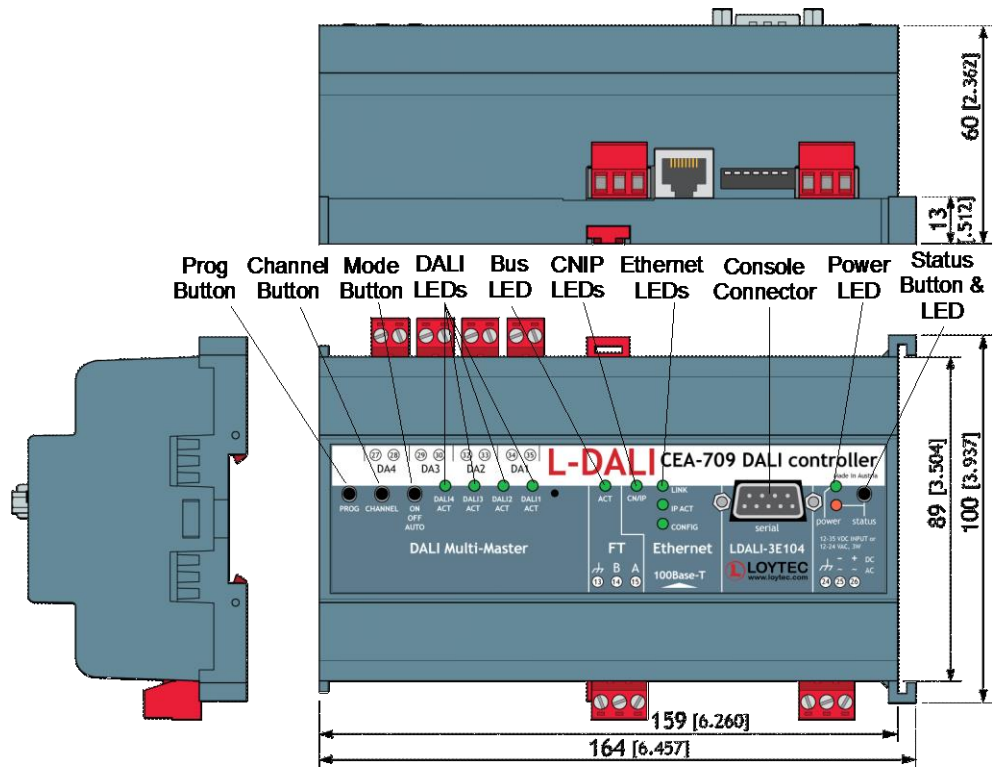

Figure 56: LDALI-3E10X and LDALI-ME204 Enclosure (dimensions in mm [inch]).

4.2 Product Label

The product label on the side of the L-DALI contains the following information:

- Order number (e.g. LDALI-3E104-U),
- Serial number with bar-code (Ser#).

Unless stated otherwise, all bar codes are encoded using “Code 128”. An additional label is also supplied with the L-DALI for documentation purposes. The specific contents of the product label are shown on the installation sheet found in the product’s box.

4.3 Mounting

The device comes prepared for mounting on DIN rails following DIN EN 50 022. The device can be mounted in any position. However, an installation place with proper airflow must be selected to ensure that the temperature of the L-DALI device does not exceed the specified range (see Chapter 8).

4.4 LED signals

4.4.1 LDALI-3E10X-U and LDALI-ME20X-U

4.4.1.1 FT Activity LED (LDALI-10X only)

The FT port on the LDALI-3E10X-U has a three-color LED (green, red, and orange, see Figure 54). Table 2 shows different LED patterns of the port and their meaning.

Behavior	Description	Comment
GREEN flashing fast	Traffic	
GREEN flashing at 1Hz	L-DALI is unconfigured	
RED permanent	Port damaged	
RED flashing fast	Traffic with high amount of errors	
RED flashing at 1 Hz (all ports)	Firmware image corrupt Please upload new firmware	
ORANGE permanent	Port disabled	e.g. using LSD Tool

Table 2: CEA-709 Activity LED Patterns.

4.4.1.2 MSTP Activity LED (LDALI-20X only)

The MS/TP port on the LDALI-ME20X-U has a three-color MSTP Activity LED (see Figure 54). Table 3 shows the different LED patterns of the port and their meaning. A permanent color reflects a state. Flicker is for 25 ms when there is activity on the MS/TP data link layer.

Behavior	Description	Comment
GREEN permanently, flicker off	Multi-Master, token ok, flicker when traffic	Normal condition on a multi-master MS/TP network.
ORANGE flicker	Sole master, flicker when traffic	Normal condition on a single-master MS/TP network.
RED permanent, flicker GREEN	Token lost state, flicker when transmit attempt	Cable might be broken.
RED flash fast	Transmission or receive errors	This indicates bad cabling.

Table 3: MS/TP Activity LED Patterns.

4.4.1.3 DALI Activity LEDs

Each DALI interface on the L-DALI has a three color LED (green, red and orange). Table 4 shows different LED patterns and their meaning.

Behavior	Description
GREEN flashing	Traffic
RED flashing fast	Traffic with errors
RED permanent	No bus power-supply/bus-power supply failed
ORANGE permanent	Manual override to off or interface is selected
GREEN permanent	Manual override to on

Table 4: DALI Activity LED patterns.

4.4.1.4 Status LED

On the LDALI-3E10X the Status LED is a three color LED that indicates different operating states of the L-DALI's CEA-852 device.

Green: The CEA-852 device is fully functional and all CEA-852 configuration data (channel routing info, channel membership list, send list) are up-to-date.

Green flicker: If a valid CEA-709 packet is received or transmitted over the IP channel, the CNIP LED turns off for 50 ms. Only valid CEA-709 IP packets sent to the IP address of the L-DALI can be seen. Stale packets or packets not addressed to the L-DALI are not seen.

Yellow: The CEA-852 device is functional but some configuration data is not up-to-date (device cannot contact configuration server but has configuration data saved in Flash memory)

Red: The CEA-852 device is non-functional because it was rejected from the CEA-852 IP channel or shut-down itself due to an internal error condition.

Off: The CEA-852 device is non-functional because it has not been started. This can be the case if the L-DALI uses DHCP and it has not received a valid IP configuration (address) from the DHCP server.

Flashing Red at 1 Hz: The CEA-852 device is non-functional because it is started but has not been configured. Please add the device to a CEA-852 IP channel (register in configuration server).

Flashing green or orange at 1 Hz: The L-DALI's CEA-709 side of the gateway has not been commissioned yet. The color indicates the CEA-852 IP channel status as described above.

On the LDALI-ME20X-U the Status LED reflects the status of the BACnet/IP communication. It flashes green for 25 ms when BACnet packets are transmitted or received over the BACnet/IP interface.

4.4.2 LDALI-3E10X and LDALI-ME204

4.4.2.1 Power LED

The L-DALI power LED lights up green when power is supplied to terminals 24, 25, and 26.

4.4.2.2 Status LED

The L-DALI is equipped with a red status LED (see Figure 56). This LED is normally off. During boot-up the status LED is used to signal error conditions (red). If the fall-back image is executed the status LED flashes red once every second.

4.4.2.3 FT Activity LED (LDALI-10X only)

The FT port on the LDALI-3E10X has a three-color LED (green, red, and orange, see Figure 56). Table 2 shows different LED patterns of the port and their meaning.

4.4.2.4 MSTP Activity LED (LDALI-20X only)

The MS/TP port on the LDALI-ME20X has a three-color MSTP Activity LED (see Figure 56). Table 3 shows the different LED patterns of the port and their meaning. A permanent color reflects a state. Flicker is for 25 ms when there is activity on the MS/TP data link layer.

4.4.2.5 Ethernet Link LED

The Ethernet Link LED lights up green whenever an Ethernet cable is plugged-in and a physical connection with a switch, hub, or PC can be established.

4.4.2.6 Ethernet Activity LED

The Ethernet Activity LED lights up green for 6 ms whenever a packet is transmitted or received or when a collision is detected on the network cable.

4.4.2.7 Ethernet Config LED

Currently the Ethernet Config LED has no function.

4.4.2.8 CN/IP LED

On the LDALI-3E10X the CNIP LED is a three color LED that indicates different operating states of the L-DALI's CEA-852 device.

Green: The CEA-852 device is fully functional and all CEA-852 configuration data (channel routing info, channel membership list, send list) are up-to-date.

Green flicker: If a valid CEA-709 packet is received or transmitted over the IP channel, the CNIP LED turns off for 50 ms. Only valid CEA-709 IP packets sent to the IP address of the L-DALI can be seen. Stale packets or packets not addressed to the L-DALI are not seen.

Yellow: The CEA-852 device is functional but some configuration data is not up-to-date (device cannot contact configuration server but has configuration data saved in Flash memory)

Red: The CEA-852 device is non-functional because it was rejected from the CEA-852 IP channel or shut-down itself due to an internal error condition.

Off: The CEA-852 device is non-functional because it has not been started. This can be the case if the L-DALI uses DHCP and it has not received a valid IP configuration (address) from the DHCP server.

Flashing Red at 1 Hz: The CEA-852 device is non-functional because it is started but has not been configured. Please add the device to a CEA-852 IP channel (register in configuration server).

Flashing green or orange at 1 Hz: The L-DALI's CEA-709 side of the gateway has not been commissioned yet. The color indicates the CEA-852 IP channel status as described above.

On the LDALI-ME20X the CNIP LED reflects the status of the BACnet/IP communication. It flashes green for 25 ms when BACnet packets are transmitted or received over the BACnet/IP interface.

4.4.2.9 DALI Activity LEDs

Each DALI interface on the L-DALI has a three color LED (green, red and orange). Table 4 shows different LED patterns and their meaning.

4.4.3 LDALI-E101-U, LDALI-3101-U and LDALI-E101-U

4.4.3.1 Status LED

The L-DALI has a three color status LED (green, red and orange). Table 5 shows different LED patterns and their meaning.

Behavior	Description
GREEN flashing	DALI Traffic
RED flashing fast	DALI Traffic with errors
RED permanent	DALI bus-power supply failed/short
ORANGE permanent	Manual override to off
GREEN permanent	Manual override to on

Table 5: Status LED patterns.

4.4.4 Wink Action

If the L-DALI receives a wink command on any of its network ports, it shows a blink pattern on the

- CEA-709 or CNIP activity LEDs and the DALI activity LEDs (LDALI-3E10X and LDALI-ME204) or
- Status LED (LDALI-E101-U, LDALI-3101-U and LDALI-E101-U).

The LEDs turn green/orange/red (each 0.15 s). This pattern is repeated six times. After that, the activity LED of the DALI channel corresponding to the CEA-709 node on which the wink was received flashes orange six times. After that the L-DALI LEDs resume their normal behavior.

4.5 Buttons

4.5.1 Status Button

Some L-DALI models are equipped with a status button (see Figure 56). When pressing the status button shortly during normal operation of the L-DALI, it sends a “Service Pin Message” on every active CEA-709 node or a BACnet “I Am” message on all active BACnet data link layers respectively.

LDALI-10X only: Note that there is one CEA-709 node for each DALI channel and each has its own unique node ID (“Neuron ID”). Pressing the status button longer than 2 seconds will allow you to select the node to send out the “Service Pin Message” message: The DALI port LED of the currently selected node will light up orange. After 2 seconds the next available node will be selected. When the status button is released the “Service Pin Message” is sent out on the currently selected node.

As an alternative to pressing the status button, a service pin message can be sent via the Web interface (see LOYTEC Device User Manual [1]).

The status button can also be used to switch the device back to factory default state. Press the service button and power-cycle the device. Keep the button pressed until the LEDs illuminate orange permanently. Release the button within five seconds from that time on to reset the device to factory defaults.

4.5.2 DALI Mode Button

L-DALI without LCD display are equipped with a DALI mode button (“ON/OFF/AUTO”, see Figure 56). It is used to manually override the dim values of the attached DALI devices and constant light controller instances. Press it once and all DALI devices on the selected channels are switched on (“on mode”), press it again and all DALI devices on the selected channels are switched off (“off mode”), press it a third time and the selected channels go back to “auto mode”.

In the “on mode” and “off mode” the dim levels of the DALI devices and constant light controller instance cannot be changed via the CEA-709 or BACnet interface (“manual override”). In the “auto mode” the dim level of the DALI devices is controlled via the CEA-709 or BACnet interface respectively.

Channels are selected via the DALI Channel button (see Section 4.5.3). The current state of a DALI channel can be determined based on the corresponding DALI Activity LED (see Section 4.4.2.9).

The main purpose of the mode button is to test the wiring during installation of the DALI system.

4.5.3 DALI Channel Button

L-DALI without LCD display are equipped with a DALI Channel button (“CHANNEL”, see Figure 56). It is used to select a specific channel. All other functions which can be performed via the DALI button interface (e.g. select DALI mode, see Section 4.5.2) are applied only to the selected DALI channel(s).

By default all DALI channels are selected. If the DALI Channel button is pressed once the first channel is selected and the corresponding DALI Activity LED lights up orange. Now each time the button is pressed the next channel is selected. If the last DALI channel is selected and the button is pressed once again, all DALI channels are selected. If no button is pressed for more than 15 seconds, the current selection is canceled.

4.5.4 DALI Program Button

L-DALI without LCD display are equipped with a DALI Program button (“PROG”, see Figure 56). It is used to replace a broken ballast. When the button is pressed, the L-DALI scans the selected DALI channel for missing and unconfigured ballasts. If exactly one missing ballast and one unconfigured ballast are found on a channel, the unconfigured ballast is used to replace the missing ballast. That is, the unconfigured ballast is configured with the address and the configuration parameters of the missing ballast. If multiple missing ballasts or multiple unconfigured ballasts are found, the Web UI or LINX Configurator software must be used to replace the missing ballast(s) (see LOYTEC Device User Manual [1] and LINX Configurator User Manual [2]).

During the replace operation, the DALI Activity LED of the corresponding channel lights up orange. If the operation was successful, the LED lights up green for 0.5 seconds, if it failed, the LED lights up red for 0.5 seconds.

Which channels are selected can be controlled via the DALI Channel button (see Section 4.5.3).

4.6 DIP Switch Settings

L-DALI models without LCD display are equipped with a DIP switch. The DIP switch assignment is shown in Table 6. Please leave all switches at default state.

DIP Switch #	Function	Factory Default
1	Must be OFF	OFF
2	Must be OFF	OFF
3	Must be OFF	OFF
4	Must be OFF	OFF
5	Must be OFF	OFF
6	Must be OFF	OFF
7	Must be OFF	OFF

Table 6: DIP Switch Settings for L-DALI.

4.7 Wiring

The wiring information of the product and its terminal layout are shown on the installation sheet found in the product’s box.

5 Workflows for the L-DALI

This section discusses a number of work flows for configuring the L-DALI in different use cases in addition to the simple use case in the quick-start scenario (see Chapter 3). The description is intended to be high-level and is depicted in flow diagrams. The individual steps refer to later sections, which describe each step in more detail. The following use cases are defined:

- On-Line using LINX Configurator (see Section 5.1.1)
- Off-Line (see Section 5.1.2)

5.1.1 On-Line

The flow diagram in Figure 57 shows the steps that need to be followed in order to configure the L-DALI when the device and the DALI network including all DALI devices (e.g. ballasts, sensors, etc.) are available on-line. For details on the LINX Configurator see LINX Configurator User Manual [2].

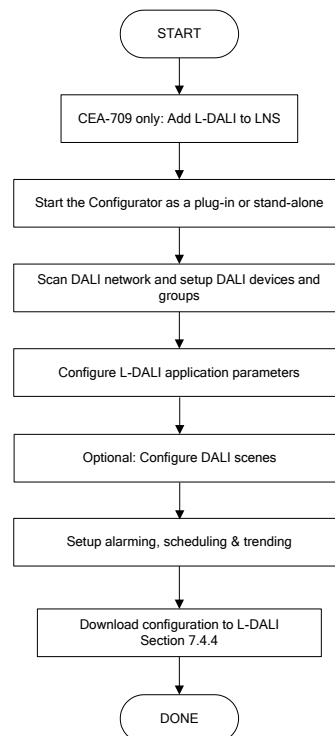

Figure 57: Basic on-line design-flow.

In case of LDALI-10X models are used in a LonWorks network, which is managed by an LNS network management tool, in the first step the L-DALI device must be added to LNS.

Then the LINX Configurator must be started to configure the L-DALI. Use Plug-In mode if working with an LNS based tool (CEA-709 only) or stand-alone mode otherwise. In the Configurator, the DALI network is scanned for DALI devices and the devices are setup and assigned to DALI groups. Then the parameters for the light application and the sunblind application can be configured. Optionally, DALI scenes and alarming, scheduling and trending functionality can be set up. Finally, the configuration needs to be downloaded to the L-DALI. It is recommended to save the complete configuration to a file for being able to replace an L-DALI in the network. Additionally a backup should be created.

To add more DALI devices, change DALI group assignment or application parameters simply repeat the steps described above.

5.1.2 Off-Line

The flow diagram in Figure 58 shows the steps that need to be followed in order to configure the L-DALI off-line. In this scenario the first steps can be performed without the L-DALI and the DALI network being physically available. This allows to prepare the on-line commissioning and thus to speed up the time required for on-site installation. Further, some steps of the on-line commissioning part can be performed by less skilled personnel using the L-DALI Web Interface.

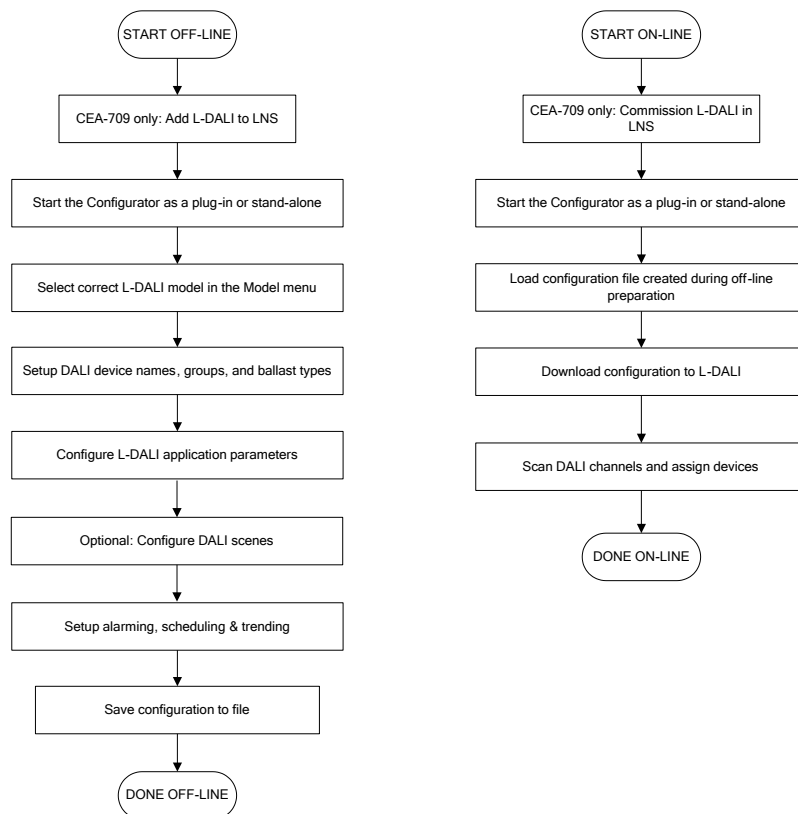

Figure 58: Basic off-line design-flow.

In case of LDALI-10X models are used in a LonWorks network, which is managed by an LNS network management tool, in the first step the L-DALI device must be added to LNS. Then the LINX Configurator must be started to configure the L-DALI. Use Plug-In mode if working with an LNS based tool (CEA-709 only) or stand-alone mode otherwise. Select the correct L-DALI model in the **Model** menu. Note, that the device is off-line. Next setup names, groups and optionally device type for the DALI devices. The names assigned must allow identifying physical devices later on (e.g. “Room 301-1” for first ballast in room 301). The device type (e.g. emergency light) must be selected if any device type specific parameters shall be configured in the next step. Then configure the parameters for the light

application and the sunblind application. Optionally, DALI scenes and alarming, scheduling and trending functionality can be set up. Save the created configuration to a file.

When the L-DALI is physically available, in case of a LDALI-10X model, first commission all ports of the device in LNS. Then again start the Configurator in plug-in mode. Load the file created during the off-line preparation and download the configuration to the L-DALI. Now, scan the DALI channels, either using the Configurator or the Web Interface and assign the DALI devices found to the names entered during off-line preparation. Finally, it is recommended to upload and save the complete configuration to a file for being able to replace an L-DALI in the network. Additionally a backup should be created.

To add more DALI devices, change DALI group assignment or application parameters it is recommended to use the on-line work flow (see Section 5.1.1).

5.1.3 Replace an L-DALI

An L-DALI can be replaced in the network by another unit. This might be necessary if a hardware defect occurs. If a backup of the latest configuration is available, restoring the backup is the best option.

The work flow to restore a device from the corresponding LINX Configurator project file is depicted in Figure 59. First of all, the replacement L-DALI needs to be configured with the appropriate IP settings and all relevant system settings (BACnet device ID, CEA-852 device settings, etc).

Start the LINX Configurator software stand-alone and connect via direct method. Load the LINX Configurator project file from the directory, which has been saved when the original L-DALI has been configured or modified. Double-check, if the DALI configuration seems ok and all DALI devices in use are assigned, that is, have a valid short address assigned. Then download the configuration to the L-DALI.

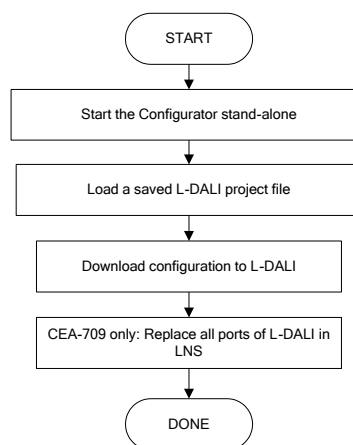

Figure 59: Basic work flow to configure a replacement device.

If using an LNS-based tool, all ports of the L-DALI device need to be replaced in that tool at some later point in time as the NID has changed. If you are not using LNS, then refer to your network management tool's reference manual on how to replace a device.

5.1.4 Enable Legacy NM Mode (LDALI-10X only)

For CEA-709/LonWorks network management tools, which do not support the ECS (extended command set) network management commands, the legacy network management mode must be configured. Please contact the tool's vendor for information whether ECS is

supported or not. Note, that changing to legacy network management mode changes the static interface of the device and thus requires different XIF files.

The legacy mode can be enabled using the Web Interface (see LOYTEC Device User Manual [1]) or the **System Settings** tab in the **Project Settings** dialog of the Configurator Software (see LINX Configurator User Manual [2]).

5.1.5 Configuration Upload and Download

When uploading or downloading the configuration of an L-DALI device using the LINX Configurator the following items are available for download (see Figure 60):

- **Datapoint Configuration:** Contains everything configured on the Datapoints tab, the Local and Global connections tabs and in the project settings except for the system settings. Typically this includes any changes to the L-DALI's NV or BACnet interface (Project Settings), local alarm, scheduler, calendar, and trendlog objects, e-mail templates, math objects and user created data points.

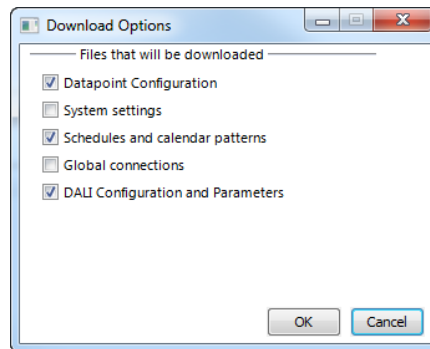

Figure 60: Download Options Dialog.

- **System settings:** Contains the configuration setup in the System Settings tab of the Project Settings.
- **Scheduler and calendar patterns:** Contains the schedule and calendar configuration (“contents” of scheduler and calendar objects).
- **Global connections:** Contains everything configured in the Global connections tab. Do not download Global connections using the LINX Configurator if using LWEB-900 software to configure and manage global connections!
- **DALI Configuration and Parameters:** The DALI Configuration contains the configuration of the DALI network, including device names, device types, device assignment (DALI short address), scene values, group names and group assignment as configured on the DALI Installation, DALI Groups, DALI Channel and DALI Scenes tabs. The Parameters contain the parameters of the L-DALI light and (if available) sunblind applications, including CLC Bindings and button functions as configured on the Parameters tab.

In the default settings all items are uploaded and downloaded. The **Project Settings** allow to select items for the download in the tab **General** (see Figure 61).

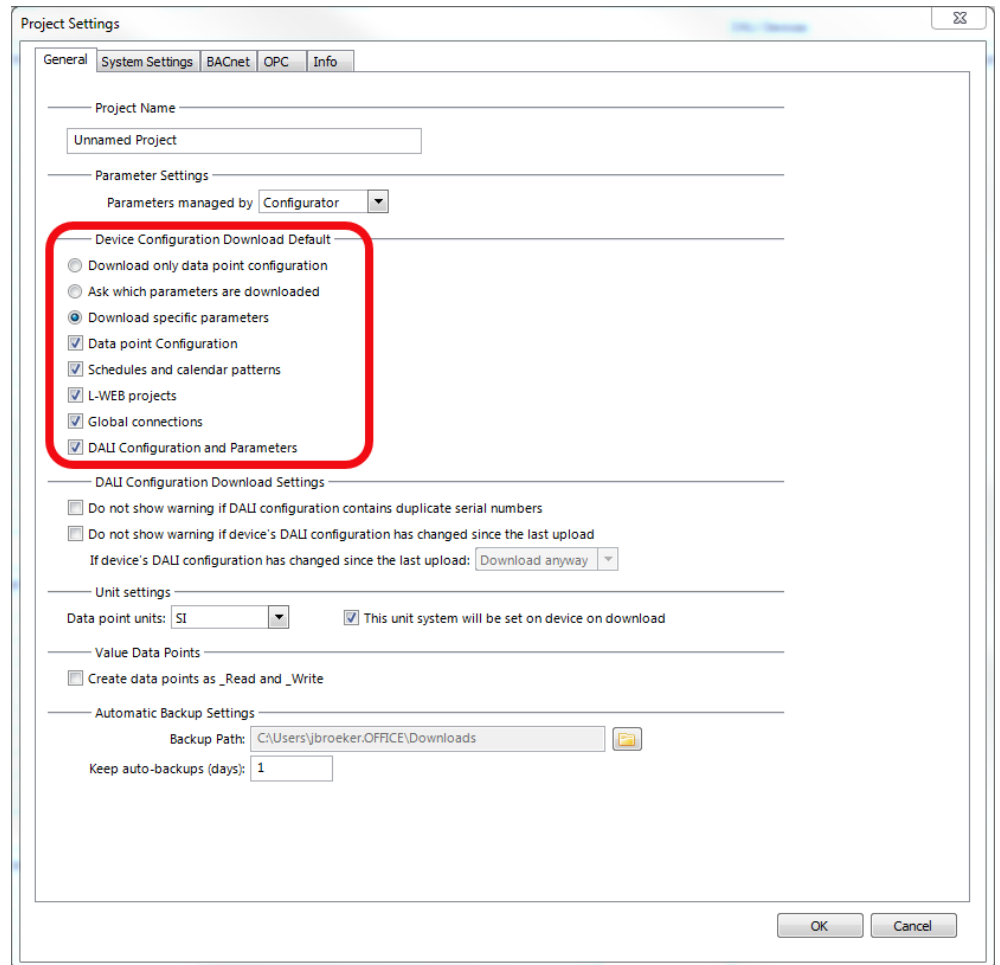

Figure 61: Device Configuration Download settings.

Tip!

To speed up your work flow only download the configuration items changed. In applications where no AST features are used it is sufficient to download DALI Configuration and Parameters!

6 L-DALI Lighting Application

The L-DALI controllers come with a standard lighting application. The behavior of the application and the data points available are slightly different for the BACnet and the CEA-709 version of the L-DALI. The following sections describe the application, the data point interface available and the web interface specific for the L-DALI lighting application.

6.1 CEA-709 Interface and Application (LDALI-10X only)

Depending on the L-DALI device type 1 (LDALI-3E101-U/LDALI-E101-U/LDALI-3101-U), 2 (LDALI-3E102/ LDALI-3E102-U), or 4 (LDALI-3E104/ LDALI-3E104-U) DALI channels are supported. Each DALI channel is implemented as a separated CEA-709 node. Every one of these up to four CEA-709 nodes is a full grown CEA-709 node, including its own unique node id (“Neuron ID”), network address, network variable tables etc. However, all these nodes share one common physical network connection.

All configuration properties listed in this section are implemented as Configuration Parameters using configuration files (CPT, CPV, and CPC files). File access is provided via LONMARK FTP.

Note: It is recommended to start the LINX Configurator as LNS-Plug-In, whenever using a LDALI-10X with an LNS based network management tool (LonMaker, NL220, etc.)! This allows the Plug-In to keep the device configuration in-sync with the LNS database.

The L-DALI can be used with different static network interface configurations. Depending on the application the different object types can be enabled or disabled to add functionality (e.g. button support or additional network variables for applications with emergency lights) or to reduce the number of objects, network variables and configuration properties respectively.

The interface configuration can be chosen via the Project Settings in the Configurator Software (see LINX Configurator User Manual [2]).

The LONMARK objects not specific to the L-DALI (Node Object, Real-Time Keeper Object, Calendar Object, Scheduler Object, etc.) are described in the LOYTEC Device User Manual [1].

6.1.1 Lamp actuator Object #3040

There are three different types of the lamp actuator objects:

- Lamp actuator object: related to DALI lamp (64 per channel)
- Group actuator object: related to DALI group (16 per channel).

- Channel actuator object: related to the DALI channel (1 per channel).

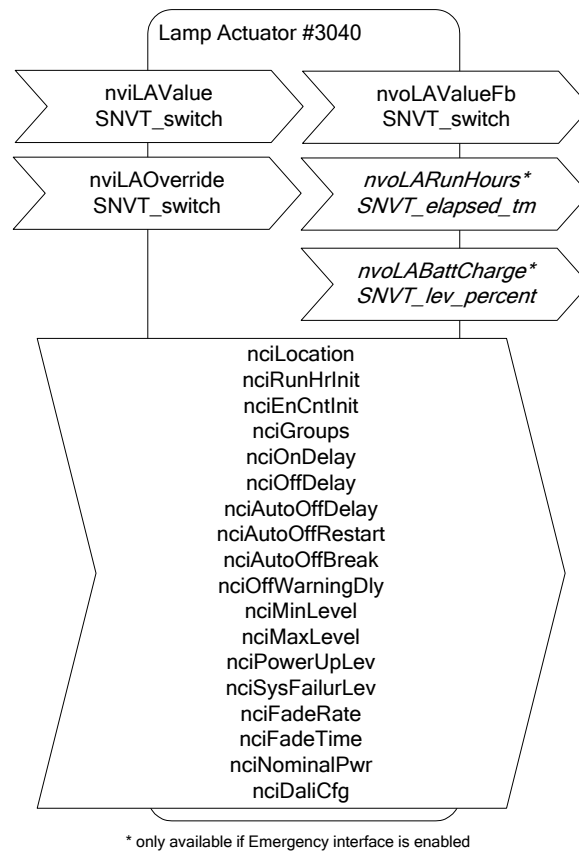

Figure 62: Lamp Actuator Object

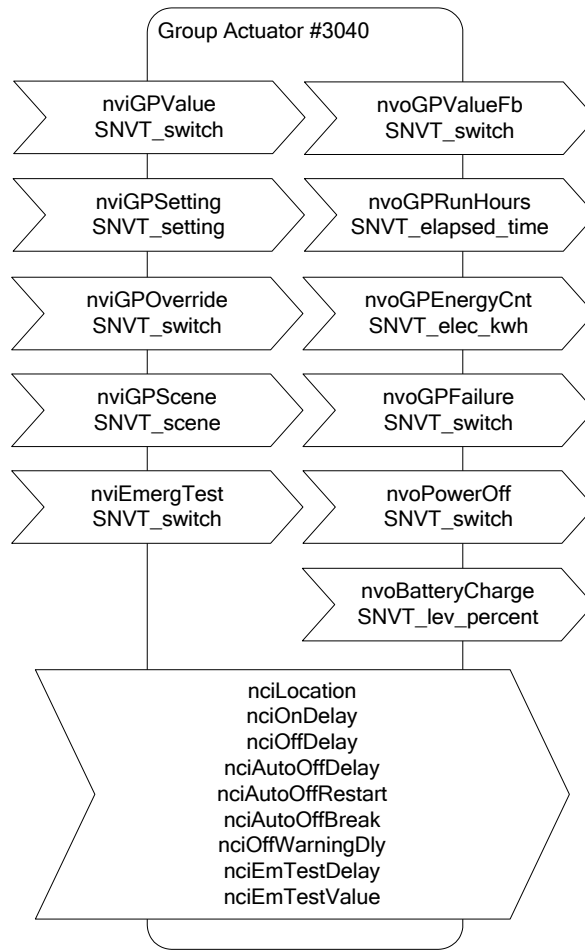

Figure 63: Group Actuator Object

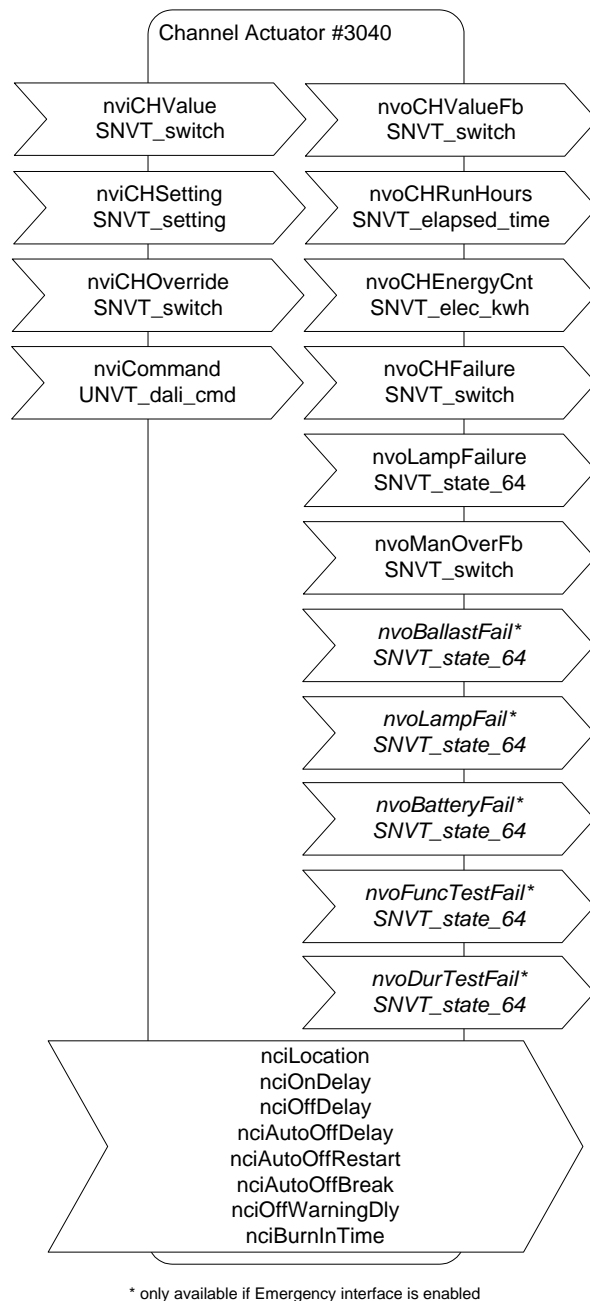

Figure 64: Object for channel

These object types are enabled in the default interface. They can be disabled.

Note: If the Lamp Actuator objects are disabled, the functional blocks are still present, but only contain the configuration properties corresponding to the DALI parameters of the corresponding ballast.

6.1.1.1 Control

The L-DALI offers different methods to control lamps. All network variables described below have the same priority. This means that the last network variable update determines the state of the lamp.

Individual Control

Each lamp can be controlled individually via the switch input network variable *nviLAValue* of the lamp actuator object. Any new value received is transmitting to the corresponding DALI lamp in fading mode (configuration property *nciFadeTime* is used).

Group Control

Lamps belonging to a group can be controlled together by the following network variables of the group actuator object.

- ***nviGPValue***: This network variable has the same functionality as *nviLAValue* but controls a whole group. Any new value received is transmitting to the DALI lamps in the group using fading mode (configuration property *nciFadeTime* is used).
- ***nviGPSetting***: Using this input network variable of type SNVT_setting dimming devices can change the brightness relatively. By *function* = SET_UP or *function* = SET_DOWN the light is dimmed relatively by the amount defined in the corresponding *setting* field. By *function* = SET_STOP ongoing fades are stopped. When the light is switched off by *function* = SET_OFF, the last light level is saved temporarily. When the light is switched on again (*function* = SET_ON) the remembered light level is restored. An absolute light level can be set by *function* = SET_STATE. The corresponding *setting* field defines the target light level. The light value is changed in ramping mode (configuration property *nciFadeRate* is used).
- ***nviGPScene***: Using this input network variable of type SNVT_scene up to 16 DALI scenes can be saved and recalled. The command SC_LEARN stores the current light levels of all lamps of the group in the specified scene number. Alternatively DALI scenes can be configured using the DALI Scenes page in the web interface (see LOYTEC Device User Manual [1]) or the DALI Scenes tab in the LINX Configurator (see LINX Configurator User Manual [2]). By a SC_RECALL command previously stored scenes can be recalled. Recalling scene 255 will relinquish any manual override and (re-)activate a constant light controller linked to the group (see Section 6.1.4.4). Scenes can be deleted by a SC_RESET command. When a new scene is selected the lamp values are adjusted in fading mode (configuration property *nciFadeTime* is used). As scene numbers in SNVT_scene start with 1, while DALI scene numbers start with 0, SNVT_scene number minus 1 will give the DALI scene number (SNVT_scene number 1 maps to DALI scene number 0, SNVT_scene number 2 maps to DALI scene number 1 etc.).

Channel Control

All lamps on the same DALI channel can be controlled together by the following network variables of the channel actuator object.

- ***nviCHValue***: This input network variable works in the same way as *nviLAValue* and *nviGPValue* but affects all lamps on a channel.
- ***nviCHSetting***: This input network variable works in the same way as *nviGPSetting* but affects all lamps on a channel.

6.1.1.2 Maximum and Minimum Light Level

For a dimmable lamp the maximum and minimum light level of a lamp can be configured via the configuration properties *nciMinLevel* and *nciMaxLevel* of type SNVT_switch.

For a non-dimmable lamp set *nciMinLevel* = *nciMaxLevel* = 100%.

6.1.1.3 Timing Parameters

Figure 65 shows the behavior of the lamp actuator if the light is switched on/off via one of the switch (*nviLValue*, *nviGValue*, *nviCHValue*) or via one of the setting input network variables (*nviGASetting*, *nviCHSetting*). When the ON command is received, the lamp is switched to the specified value after the time *nciOnDelay* has expired. When the lamp is already on and a new ON command is received the lamp is switched to the new value immediately. If the lamp is on and an OFF command is received the lamp is switched off after the time *nciOffDelay*.

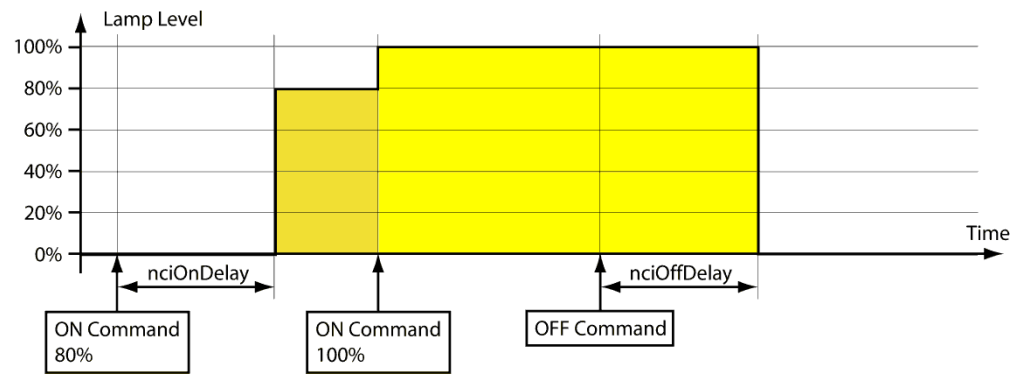

Figure 65: Timing Parameters

For staircase lighting an automatic cutoff can be configured in *nciAutoOffDelay* as shown in Figure 66. When this time expires, the lamp switches off automatically. To warn the user that the light is going to turn off, an off-warning delay (*nciOffWarningDly*) can be configured. During this time the light is dimmed to 50% of the previous level. For non-dimmable lights (*nciMinLevel=nciMaxLevel*) the light is blinking.

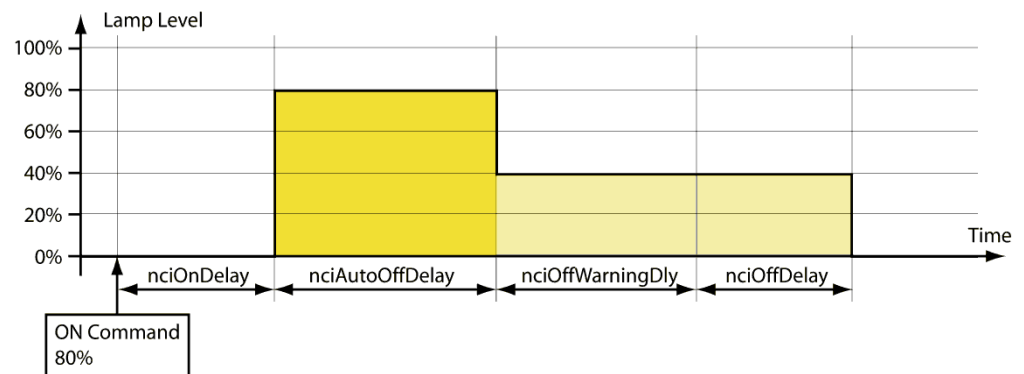
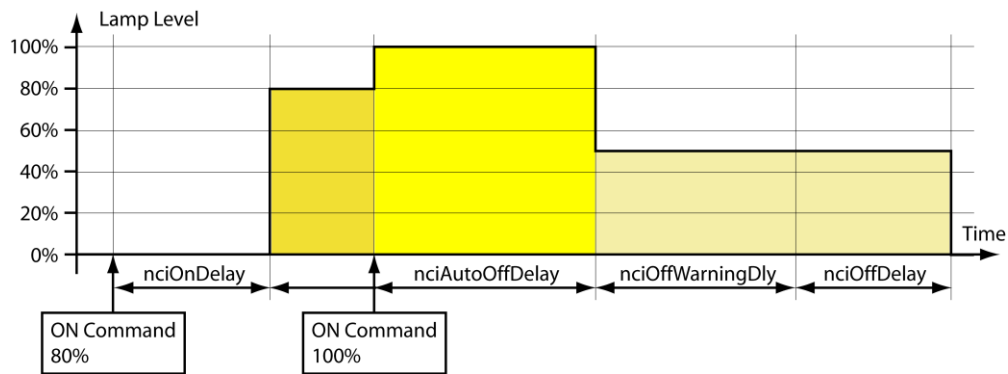
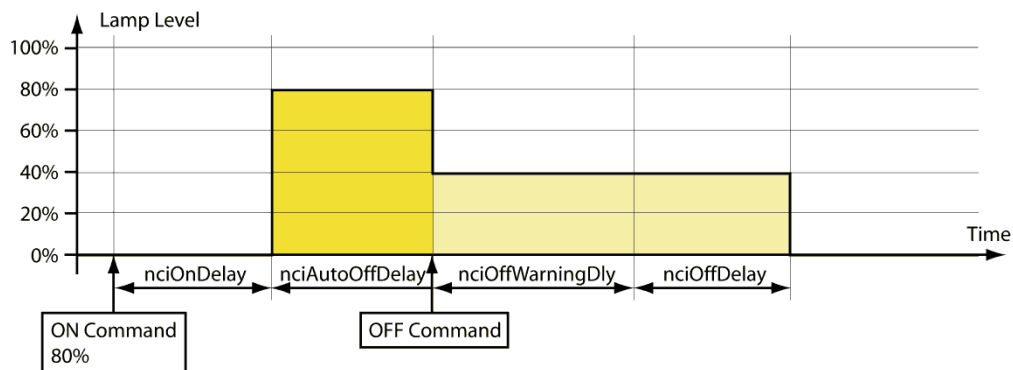

Figure 66: Timing Parameters with *nciAutoOffDelay* and *nciOffWarningDly*

The behavior of the auto-off timer can be modified with the two configuration properties *nciAutoOffRestart* and *nciAutoOffBreak*. If *nciAutoOffRestart* is set to *ST_ON*, the auto-off timer can be restarted by a new ON command (see Figure 67). If *nciAutoOffBreak* is set to *ST_ON* the auto-off timer can be stopped before the time has expired by switching the light off via one of the applicable input network variables (see Figure 68).

Figure 67: Timing Parameters (*nciAutoOffRestart=ST_ON*)Figure 68: Timing Parameters (*nciAutoOffBreak=ST_ON*)

6.1.1.4 Prioritized Control

Lamp values can be overridden by the following network variables:

- ***nviLAOverride***: This input network variable of type SNVT_switch overrides the value of *nviLAValue*.
- ***nviGPOverride***: This input network variable of type SNVT_switch overrides the value of *nviGPValue*, *nviGPSetting*, and *nviGPScene*.
- ***nviCHOverride***: This input network variable of type SNVT_switch overrides the value of *nviCHValue* and *nviCHSetting*.

If *nviXXOverride* is valid (.state=0/1) it controls the lamp/group/channel output. Updates of on the non-priorized input network variables (see Section 6.1.1.1) are ignored. If *nviXXOverride* is set to invalid (.state=-1) control of the lamp/group/channel output is returned to the non-priorized input network variable.

The light value is changed in fading mode (configuration property *nciFadeTime* is used).

Prioritized control commands are not affected by the timing parameters described in Section 6.1.1.3.

6.1.1.5 Feedback

The lamp object, group object and channel object each report the current state via a feedback variable of type SNVT_switch:

- ***nvoLAValueFb***: lamp object feedback

- *nvoGPValueFb*: group object feedback
- *nvoCHValueFb*: channel object feedback

The channel object reports if it is in manual override mode via the network variable *nvoManOverFb*.

6.1.1.6 Emergency Lights

The L-DALI supports testing of emergency lights using its CEA-709 interface. The test is started and stopped by using the network variable input *nviEmergTest*, which is available in each Group Actuator object. To start the test the *state* part of the *SNVT_switch* must be set to SW_ON (1). The *value* part selects one of the following tests:

- **Function test** (*value* = 1%): Starts the function test of all DALI emergency lights in this group, which support this function. For details on the DALI emergency lighting function test see IEC 62386-202. If the Emergency interface is enabled the *nvoFuncTestFail* will show whether the last function test performed has failed (see below).
- **Duration test** (*value* = 2 %): Starts the duration test of all DALI emergency lights in this group, which support this function. For details on the DALI emergency lighting duration test see IEC 62386-202. If the Emergency interface is enabled the *nvoDurTestFail* will show whether the last duration test performed has failed (see below).
- **Mains test** (*value* = 100%): Typically used in a central battery system, to verify lights are dimmed to the emergency level when mains fail. When the test is started via *nviEmergTest*, the power of the emergency lamps is cut by setting the switch network variable output *nvoPowerOff* to ON. After the delays *nciEmTestDelay*, the value of all lamps in the group is compared to the reference value specified in *nciEmTestValue*. If a lamp does not reach the reference value (dim value above or below reference value) or if a lamp is offline, an alarm is generated as shown in Figure 69.

Test results will be stored in the appropriate emergency light test log (see LOYTEC Device User Manual [1]). To abort any active test the *SNVT_switch* must be set to {SW_OFF, 0%}. To periodically execute tests a scheduler controlling *nviEmergTest* can be configured.

The screenshot shows the LOYTEC Alarm interface. The top header includes the LOYTEC logo and the word "Alarm". On the left, there is a navigation menu with "Device Info" and "Config" sections. The "Config" section is expanded, showing options like System, Passwords, Backup/Restore, Port Config, E-mail, DALI Installation, DALI Groups, Data Points, Trend, Scheduler, Calendar, Alarm, and Debug. The main content area displays "Alarm Object Name: Local Alarms" and a "Summary" table. Below the summary is a "Details" table showing two alarm entries.

State	Number
Active, not acknowledged	2
Active, acknowledged	0
Inactive, not acknowledged	0
Others	0

Alarm Time	Type	Priority	Description	Source Name	Value	Ack
04.05.2010 12:30:26	fault	0	Emergency test failed	lamp_306_window_10		Ack
04.05.2010 12:30:26	fault	0	Emergency test failed	lamp_306_window_00		Ack

Figure 69: Emergency Light Test Alarm

If the interface configuration **Emergency** is selected the following additional, emergency light related network variables are available:

- *nvoLARunHour* (Lamp Actuator): Report run-hours per ballast.

- *nvoLABattCharge* (Lamp Actuator): Report battery charge per emergency light ballast (if ballast supports it).
- *nvoBatteryFail* (Channel Actuator): Report battery failure for each emergency light ballast.
- *nvoFuncTestFail* (Channel Actuator): Report whether last function test failed for each emergency light ballast.
- *nvoDurTestFail* (Channel Actuator): Report whether last function test failed for each emergency light ballast.

6.1.1.7 Status Monitoring

The L-DALI monitors the DALI lamps and reports any failure in the output network variables *nvoGPFailure* (group object) and *nvoCHFailure* (channel object).

A lamp failure is reported if either

- bus power for the related DALI channel fails,
- the DALI ballast is not reachable via the DALI channel, or
- the DALI ballast reports a failure (e.g. lamp failure) in its DALI status register.

The value of the network variable *nvoGPFailure* of the group object reflects the percentage of failed ballasts in this group.

The value of the network variable *nvoCHFailure* of the channel object reflects the percentage of failed ballasts in this channel.

The network variable *nvoLampFailure* of type SNVT_state_64 reports the status of the all lamps in a channel. Each bit corresponds to the lamp with the same index. In case of a failure the bit is set.

6.1.1.8 Statistics

The L-DALI reports the run hours and energy consumptions of the DALI lamps.

Run Hours

The L-DALI determines how long each DALI lamp was switched on. If a lamp is replaced the run hours can be initialized via the configuration property *nciRunHrInit* of the lamp object. To limit the number of network variables the run hours are reported not separately for each lamp but for a whole group or channel.

The group object reports the maximum run hours of all lamps in the groups via the output network variable *nvoGPRunHours*.

The channel object reports the maximum run hours of all lamps on the channel via the output network variable *nvoCHRunHours*.

Energy Consumption

The L-DALI device can calculate the energy consumption of the DALI lamps. For that purpose it needs to know the nominal power of all connected DALI lamps. If the configuration property *nciNominalPwr* of the lamp object is set to 0 (AUTO), the L-DALI tries to obtain the energy consumption from the DALI device. However, not all DALI ballasts support this proprietary extension. In this case the *nciNominalPwr* has to be configured with the nominal power of the ballast. The energy consumption can be initialized via the configuration property *nciEnrgyCntInit* of the lamp object.

To reduce the number of network variables the energy consumption is reported not separately for each lamp but for a whole group or channel. The group object reports the sum of energy consumed by all lamps in the groups via the output network variable *nvoGPEnergyCnt*. Equally the network variable *nvoCHEnergyCnt* reports the sum of energy consumed by all lamps on the channel.

6.1.1.9 Burn-In Function

Some lamps require a burn-in time during which they must not be dimmed. The burn-in mode can be activated by setting the *nviCommand* network variable of the channel object to *START_BURN_IN*. The burn-in time is defined by the configuration property *nciBurnInTime*. During this time the lamps will only be switched to on (100%) or off (0%) but not dimmed. To abort the burn-in mode prematurely *nviCommand* can be set to *STOP_BURN_IN*.

6.1.1.10 Fail Safe Functions

The light level a lamp adopts after power-up is defined in the configuration property *nciPowerUpLev*.

The light level a lamp adopts in case of a DALI system failure is defined in the configuration property *nciSysFailureLev*.

6.1.1.11 Colour Control

Controlling the colour of devices of type “colour control” (device type 8) is possible

- **absolute** using *nviCommand* (Channel actuator object): Using the command (*.cmd* field) *DALI_CMD_SET_COLOUR*, DALI native colour control commands can be triggered. For details see the description of *nviCommand* below (Section 6.1.1.12).
- **absolute** using *nviGPSetting* (Group actuator object) and *nviCHSetting* (Channel actuator object): For a more convenient operation via a UI, colour control is possible via two additional functions of the *nviXXSetting* NVs. The function (*.function* field) *SET_TC* (126) allows to set the colour temperature in Kelvin, while *SET_COLOUR* (127) allows to change the lamp colour by supplying hue and saturation values. In the latter case the different native DALI colour control methods (xy-coordinate, RGBWAF, primary-N) are abstracted (converted). Hue is an angular value, starting at the red primary at 0°, passing through the green primary at 120° and the blue primary at 240°, and then wrapping back to red at 360°. Saturation can be in the range of 0% to 100%. For details see the description of *nviXXSetting* below (Section 6.1.1.12).
- **via scene** using *nviGPScene* (Group actuator object): This NV allows recalling DALI scenes. DALI scenes can contain lamp colour settings (for ballasts with DT8 support) as well as dim levels. These scenes can be defined using the DALI scenes tab in the LINX Configurator (see LINX Configurator User Manual [2]) or in the DALI scenes web-UI (see LOYTEC Device User Manual [1]). Note, that DALI scenes can be used to change lamp colour without affecting the dim level (and vice versa). For details see the description of *nviGPScene* below (Section 6.1.1.12).

6.1.1.12 Input Network Variables

nviXXValue	
Type	SNVT_switch
Valid Range	.value: 0..100% .state: 0, 1 On: .state = 1 and .value > 0 Off: .state = 0 and .value=any or .state=1 and .value = 0
Default Value	-
Description	Used to control the lamp/group/channel. This input is effective only if <i>nviXXOverride.state</i> is invalid (-1). If an update is received on this network variable the corresponding DALI lamp/group/channel is dimmed in fading mode (constant time, configuration property <i>nciFadeTime</i> is used). Lamp actuator only: If an invalid value is received, the lamp adopts the level defined by the <i>nciSysFailurLev</i> .

nviXXSetting																	
Type	SNVT_setting																
Valid Range	.function: SET_OFF, SET_ON, SET_UP, SET_DOWN, SET_STATE .setting: 0..100%																
Default Value	-																
Description	Used to control the group/channel. This input is effective only if <i>nviXXOverride.state</i> is invalid (-1). <table border="1" data-bbox="311 1064 1289 1814"> <thead> <tr> <th>Function</th> <th>Description</th> </tr> </thead> <tbody> <tr> <td>SET_UP, SET_DOWN</td> <td>The light is dimmed relatively by the amount defined in the .setting field.</td> </tr> <tr> <td>SET_STOP</td> <td>Stop an ongoing fade.</td> </tr> <tr> <td>SET_OFF</td> <td>The light is switched off and the last light level is saved temporarily.</td> </tr> <tr> <td>SET_ON</td> <td>The light is switched on to the light level saved at the time of the last SET_OFF command.</td> </tr> <tr> <td>SET_STATE</td> <td>Set the light to the level defined by the .setting field.</td> </tr> <tr> <td>SET_TC (126)</td> <td>Set the colour temperature of a luminaire supporting DT8 Tc colour control (tunable white) to the value given in the .rotation field. The value in the .rotation field is interpreted as raw value in Kelvin (0-32767 Kelvin, 1 Kelvin resolution).</td> </tr> <tr> <td>SET_COLOUR(127)</td> <td>Set the lamp colour of a luminaire supporting DT8 xy-coordinate, RGBWAF or primary-N colour control. The value in the .rotation field is interpreted hue, while the .setting field is interpreted as saturation. Hue is an angular value, starting at the red primary at 0°, passing through the green primary at 120° and the blue primary at 240°, and then wrapping back to red at 360°. Saturation can be in the range of 0% to 100%. The controller converts the hue and saturation values given to the respective native DALI colour control values (xy-coordinate, RGBWAF or primary-N) as supported by the luminaire. This abstraction allows to use a control algorithm or user interface independent of the supported DALI colour control method</td> </tr> </tbody> </table> <p>The light is dimmed in ramping mode (constant rate, configuration property <i>nciFadeRate</i> is used). For colour changes the <i>nciFateTime</i> is used.</p>	Function	Description	SET_UP, SET_DOWN	The light is dimmed relatively by the amount defined in the .setting field.	SET_STOP	Stop an ongoing fade.	SET_OFF	The light is switched off and the last light level is saved temporarily.	SET_ON	The light is switched on to the light level saved at the time of the last SET_OFF command.	SET_STATE	Set the light to the level defined by the .setting field.	SET_TC (126)	Set the colour temperature of a luminaire supporting DT8 Tc colour control (tunable white) to the value given in the .rotation field. The value in the .rotation field is interpreted as raw value in Kelvin (0-32767 Kelvin, 1 Kelvin resolution).	SET_COLOUR(127)	Set the lamp colour of a luminaire supporting DT8 xy-coordinate, RGBWAF or primary-N colour control. The value in the .rotation field is interpreted hue, while the .setting field is interpreted as saturation. Hue is an angular value, starting at the red primary at 0°, passing through the green primary at 120° and the blue primary at 240°, and then wrapping back to red at 360°. Saturation can be in the range of 0% to 100%. The controller converts the hue and saturation values given to the respective native DALI colour control values (xy-coordinate, RGBWAF or primary-N) as supported by the luminaire. This abstraction allows to use a control algorithm or user interface independent of the supported DALI colour control method
Function	Description																
SET_UP, SET_DOWN	The light is dimmed relatively by the amount defined in the .setting field.																
SET_STOP	Stop an ongoing fade.																
SET_OFF	The light is switched off and the last light level is saved temporarily.																
SET_ON	The light is switched on to the light level saved at the time of the last SET_OFF command.																
SET_STATE	Set the light to the level defined by the .setting field.																
SET_TC (126)	Set the colour temperature of a luminaire supporting DT8 Tc colour control (tunable white) to the value given in the .rotation field. The value in the .rotation field is interpreted as raw value in Kelvin (0-32767 Kelvin, 1 Kelvin resolution).																
SET_COLOUR(127)	Set the lamp colour of a luminaire supporting DT8 xy-coordinate, RGBWAF or primary-N colour control. The value in the .rotation field is interpreted hue, while the .setting field is interpreted as saturation. Hue is an angular value, starting at the red primary at 0°, passing through the green primary at 120° and the blue primary at 240°, and then wrapping back to red at 360°. Saturation can be in the range of 0% to 100%. The controller converts the hue and saturation values given to the respective native DALI colour control values (xy-coordinate, RGBWAF or primary-N) as supported by the luminaire. This abstraction allows to use a control algorithm or user interface independent of the supported DALI colour control method																

nviXXOverride	
Type	SNVT_switch
Valid Range	.value: 0..100% .state: 0, 1, -1
Default Value	-
Description	<p>If <i>nviXXOverride</i> is valid (.state=0/1), the current lamp/group/channel output is saved temporarily and the lamp/group/channel output is set to the specified value.</p> <p>If <i>nviXXOverride</i> is set to invalid (.state=-1), the lamp/group/channel output is set to the previously saved value.</p> <p>The light is dimmed in fading mode (constant time, configuration property <i>nciFadeTime</i> is used).</p>

nviGPScene									
Type	SNVT_scene								
Valid Range	.function: SC_LEARN, SC_RECALL, SC_RESET .scene_number: 1..16, 255								
Default Value	-								
Description	<p>Using this input network variable up to 16 DALI scenes can be saved and recalled.</p> <table border="1"> <thead> <tr> <th>Function</th> <th>Description</th> </tr> </thead> <tbody> <tr> <td>SC_LEARN</td> <td>Stores the current light levels of all lamps of the group in the specified scene number.</td> </tr> <tr> <td>SC_RECALL</td> <td>Recall a previously stored scenes.</td> </tr> <tr> <td>SC_RESET</td> <td>Delete a scene.</td> </tr> </tbody> </table> <p>As values for scene_number start with 1, while DALI scene numbers start with 0, the DALI scene number is scene_number minus 1 (scene_number 1 maps to DALI scene number 0, scene_number 2 maps to DALI scene number 1 etc.).</p> <p>Recalling scene 255 will relinquish any manual override and (re-)activate a constant light controller linked to the group (see Section 6.1.4.4).</p> <p>When a new scene is selected the lamp values are adjusted in fading mode (configuration property <i>nciFadeTime</i> is used).</p>	Function	Description	SC_LEARN	Stores the current light levels of all lamps of the group in the specified scene number.	SC_RECALL	Recall a previously stored scenes.	SC_RESET	Delete a scene.
Function	Description								
SC_LEARN	Stores the current light levels of all lamps of the group in the specified scene number.								
SC_RECALL	Recall a previously stored scenes.								
SC_RESET	Delete a scene.								

nviEmergTest	
Type	SNVT_switch
Valid Range	.value: 0..100% .state: 0, 1
Default Value	-
Description	<p>Used to start the test of emergency lamps in a group. To start the test the <i>state</i> part of the <i>SNVT_switch</i> must be set to SW_ON (1). The <i>value</i> part selects one of the following tests:</p> <ul style="list-style-type: none"> • Function test (value = 1%): Starts the function test of all DALI emergency lights in this group, which support this function. For details on the DALI emergency lighting function test see IEC 62386-202. If the Emergency interface is enabled the <i>nvoFuncTestFail</i> will show whether the last function test performed has failed. • Duration test (value = 2 %): Starts the duration test of all DALI emergency lights in this group, which support this function. For details on the DALI emergency lighting duration test see IEC 62386-202. If the Emergency interface is enabled the <i>nvoDurTestFail</i> will show whether the last duration test performed has failed. • Mains test (value = 100%): Typically used in a central battery system, to verify lights are dimmed to the emergency level when mains fail. When the test is started via <i>nviEmergTest</i>, the power of the emergency lamps is cut by setting the switch network variable output <i>nvoPowerOff</i> to ON. After the delays <i>nciEmTestDelay</i>, the value of all lamps in the group is compared to the reference value specified in <i>nciEmTestValue</i>. If a lamp does not reach the reference value (dim value above or below reference value) or if a lamp is offline, an alarm is generated as shown in Figure 69. <p>Test results will be stored in the appropriate emergency light test log (see LINX Configurator User Manual [2]). To abort any active test the <i>SNVT_switch</i> must be set to {SW_OFF, 0%}.</p>

nviCommand									
Type	UNVT_dali_cmd								
Valid Range	.cmd: START_BURN_IN=0, STOP_BURN_IN=1, DALI_CMD_SET_COLOUR=2 .data.type: BALLAST=0, GROUP=1, CHANNEL=2 .data.index: 0..63 .data.arg: Union containing arguments depending on selected command.								
Default Value	-								
Description	<p>Used to start and stop the burn-in mode.</p> <table border="1"> <thead> <tr> <th>Function</th> <th>Description</th> </tr> </thead> <tbody> <tr> <td>START_BURN_IN</td> <td>Start the burn-in mode for a ballast, group, or channel. The burn-in time is defined by the configuration property <i>nciBurnInTime</i>.</td> </tr> <tr> <td>STOP_BURN_IN</td> <td>Abort the burn-in mode for a ballast, group, or channel.</td> </tr> <tr> <td>DALI_CMD_SET_COLOUR</td> <td> <p>Change light color for ballast, group, or channel. The argument field is defined as follows:</p> <pre> struct set_colour { dali_colour_type_t type; union value { struct xy_coordinate { uint16 x; uint16 y; }; uint16 colour_temperature_tc; uint16 primary_n_dim_level[6]; struct rgbwaf { uint8 control; uint8 red; uint8 green; uint8 blue; uint8 white; uint8 amber; uint8 freecolour; }; }; }; </pre> <p>The field <i>type</i> defines the way the colour is specified:</p> <ul style="list-style-type: none"> • DALI_COLOUR_TYPE_XY_COORDINATE (0): The light colour is defined by the x any y coordinates in the CIE1931 colour space chromaticity diagram. The x and y values are given in the structure <i>value.xy_coordinate</i>. • DALI_COLOUR_TYPE_TC (1): The light colour is defined by the colour temperature Tc. Its value is given in the field <i>value.colour_temperature_tc</i>. The value has to be supplied in Mirak (=1.000.000/T). • DALI_COLOUR_TYPE_PRIMARY_N (2): The light colour is defined by the dim level of up to 6 channels. The corresponding values are given in the array <i>value.primary_n_dim_level</i>. • DALI_COLOUR_TYPE_RGBWAF (3): The light colour is defined by colour channels red, green, blue, white, amber and freecolour. See IEC 62386-209 on details. The corresponding values are given in the structure <i>value.rgbwaf</i>. <p>Note: Not all colour control types are supported by all DALI colour control ballasts. Check the documentation of the DALI ballast on which types are supported.</p> </td> </tr> </tbody> </table> <p>If the command requires an address the field <i>data.type</i> defines whether the command addresses a single ballast, a group or the all devices on the channel (broadcast). The field <i>data.index</i> gives the index of the associated lamp actuator (0-63) or group actuator (0-15) object, respectively. In case of</p>	Function	Description	START_BURN_IN	Start the burn-in mode for a ballast, group, or channel. The burn-in time is defined by the configuration property <i>nciBurnInTime</i> .	STOP_BURN_IN	Abort the burn-in mode for a ballast, group, or channel.	DALI_CMD_SET_COLOUR	<p>Change light color for ballast, group, or channel. The argument field is defined as follows:</p> <pre> struct set_colour { dali_colour_type_t type; union value { struct xy_coordinate { uint16 x; uint16 y; }; uint16 colour_temperature_tc; uint16 primary_n_dim_level[6]; struct rgbwaf { uint8 control; uint8 red; uint8 green; uint8 blue; uint8 white; uint8 amber; uint8 freecolour; }; }; }; </pre> <p>The field <i>type</i> defines the way the colour is specified:</p> <ul style="list-style-type: none"> • DALI_COLOUR_TYPE_XY_COORDINATE (0): The light colour is defined by the x any y coordinates in the CIE1931 colour space chromaticity diagram. The x and y values are given in the structure <i>value.xy_coordinate</i>. • DALI_COLOUR_TYPE_TC (1): The light colour is defined by the colour temperature Tc. Its value is given in the field <i>value.colour_temperature_tc</i>. The value has to be supplied in Mirak (=1.000.000/T). • DALI_COLOUR_TYPE_PRIMARY_N (2): The light colour is defined by the dim level of up to 6 channels. The corresponding values are given in the array <i>value.primary_n_dim_level</i>. • DALI_COLOUR_TYPE_RGBWAF (3): The light colour is defined by colour channels red, green, blue, white, amber and freecolour. See IEC 62386-209 on details. The corresponding values are given in the structure <i>value.rgbwaf</i>. <p>Note: Not all colour control types are supported by all DALI colour control ballasts. Check the documentation of the DALI ballast on which types are supported.</p>
Function	Description								
START_BURN_IN	Start the burn-in mode for a ballast, group, or channel. The burn-in time is defined by the configuration property <i>nciBurnInTime</i> .								
STOP_BURN_IN	Abort the burn-in mode for a ballast, group, or channel.								
DALI_CMD_SET_COLOUR	<p>Change light color for ballast, group, or channel. The argument field is defined as follows:</p> <pre> struct set_colour { dali_colour_type_t type; union value { struct xy_coordinate { uint16 x; uint16 y; }; uint16 colour_temperature_tc; uint16 primary_n_dim_level[6]; struct rgbwaf { uint8 control; uint8 red; uint8 green; uint8 blue; uint8 white; uint8 amber; uint8 freecolour; }; }; }; </pre> <p>The field <i>type</i> defines the way the colour is specified:</p> <ul style="list-style-type: none"> • DALI_COLOUR_TYPE_XY_COORDINATE (0): The light colour is defined by the x any y coordinates in the CIE1931 colour space chromaticity diagram. The x and y values are given in the structure <i>value.xy_coordinate</i>. • DALI_COLOUR_TYPE_TC (1): The light colour is defined by the colour temperature Tc. Its value is given in the field <i>value.colour_temperature_tc</i>. The value has to be supplied in Mirak (=1.000.000/T). • DALI_COLOUR_TYPE_PRIMARY_N (2): The light colour is defined by the dim level of up to 6 channels. The corresponding values are given in the array <i>value.primary_n_dim_level</i>. • DALI_COLOUR_TYPE_RGBWAF (3): The light colour is defined by colour channels red, green, blue, white, amber and freecolour. See IEC 62386-209 on details. The corresponding values are given in the structure <i>value.rgbwaf</i>. <p>Note: Not all colour control types are supported by all DALI colour control ballasts. Check the documentation of the DALI ballast on which types are supported.</p>								

nviCommand	
Type	UNVT_dali_cmd
	type CHANNEL the index is ignored.

6.1.1.13 Output Network Variables

nvoXXValueFb	
Type	SNVT_switch
Valid Range	.value: 0..100% .state: 0, 1 On: .state = 1 and .value > 0 Off: .state = 0 and .value=any or .state=1 and .value = 0
Default Value	-
Description	Feedback value of the lamp/group/channel object. For a lamp actuator object this value is the current state and percentage of level intensity of the corresponding DALI ballast. The <i>.state</i> part is -1 (invalid) if the ballast is not present. For a group actuator or channel actuator object this value changes, whenever all ballasts of the group/channel adopt the same dim vale.

nvoXXRunHours	
Type	SNVT_elapsed_tm
Valid Range	.day: 0..65534 .hour: 0..23 .minute: 0..59 .second: 0..59
Default Value	-
Description	Reports the run (ON) hours. L-DALI calculates the run hours of each DALI ballast. The network variable <i>nvoGPRunHours</i> reports the maximum run hours of the lamps in a group. The network variable <i>nvoCHRunHours</i> reports the maximum run hours of the lamps in a channel. The network variable <i>nvoLARunHours</i> reports the run hours of each lamp. This network variable is only present if the Emergency interface is enabled (see Section 6.1). To reduce the number of network variables, the value is not available as a network variable on the Standard interface. If a lamp is replaced the run hours of a lamp can be initialized using the configuration property <i>nciRunHrInit</i> . If the ballast is capable of maintaining the run hours by itself (e.g. some DALI emergency lights), resetting the run hours via <i>nciRunHrInit</i> will also reset the run hours counter in the ballast.

nvoXXEnergyCnt	
Type	SNVT_elec_kwh
Valid Range	0..65534 Resolution: 1kWh
Default Value	-
Description	<p>This network variable reports the energy consumption of a group or channel.</p> <p>L-DALI calculates the energy consumption of each DALI ballast. To reduce the number of network variables, the calculated value is not available as a network variable on the lamp actuator object but is used to calculate the total energy consumption for the group and channel actuator objects.</p> <p>The network variable <i>nvoGPEnergyCnt</i> reports the total energy consumption of all lamps in a group.</p> <p>The network variable <i>nvoCHEnergyCnt</i> reports the total energy consumption of all lamps in a channel.</p> <p>The nominal power of a lamp can be configured using the configuration property <i>nciNominalPwr</i>. The energy consumption of a lamp can be initialized with the configuration property <i>nciEnCntInit</i>.</p>

nvoXXFailure	
Type	SNVT_switch
Valid Range	.value: 0..100% .state: 0, 1, -1
Default Value	-
Description	<p>This network variable reports the status of the lamps in a group or channel.</p> <p>The network variable <i>nvoGPFailure</i> reports the percentage of failed ballasts in a group.</p> <p>The network variable <i>nvoCHFfailure</i> reports the percentage of failed ballasts in a channel.</p> <p>A ballast failure is reported if either</p> <ul style="list-style-type: none"> • Bus power for the related DALI channel fails, • The DALI ballast is not reachable via the DALI channel, or • The DALI ballast reports a failure (e.g. lamp failure) in its DALI status register.

nvoPowerOff	
Type	SNVT_switch
Valid Range	.value: 0, 100 .state: 0, 1
Default Value	-
Description	<p>This network variable is used during the emergency light test to cut the power.</p> <p>The power is cut with an ON value (100.0, 1) and reapplied with an OFF value (0.0, 0).</p>

nvoLampFailure	
Type	SNVT_state_64
Valid Range	.bit0: 0, 1bit63: 0, 1
Default Value	-
Description	This network variable reports the status of the ballasts in the channel. Each bit corresponds to the lamp with the same index. In case of a failure the bit is set. A failure occurs if the corresponding ballast is offline or if it indicates a lamp failure or a ballast failure.

nvoBatteryCharge, nvoLABattCharge	
Type	SNVT_lev_percent
Valid Range	-163.840..163.830 Resolution: 0.005
Default Value	-
Description	Reports the battery charge of a self-contained emergency light or a group of self-contained emergency lights (if supported by the emergency light). The network variable <i>nvoBatteryCharge</i> reports the minimum battery charge of the emergency lights in a group. The network variable <i>nvoLABattCharge</i> reports the battery charge of each self-contained emergency light. This network variable is only present if the Emergency interface is enabled (see Section 6.1). To reduce the number of network variables, the value is not available as a network variable on the Standard interface.

nvoManOverFb	
Type	SNVT_switch
Valid Range	.value: 0, 100 .state: 0, 1, -1 On: .state=1 and .value=100 Off: .state=0 and .value=0 Auto: .state=-1 and .value=0
Default Value	-
Description	This network variable reports the current state of manual override for a channel.

nvoBallastFail	
Type	SNVT_state_64
Valid Range	.bit0: 0, 1bit63: 0, 1
Default Value	-
Description	This network variable reports the status of the ballasts in the channel. Each bit corresponds to the ballast with the same index. In case the ballast indicates a ballast failure the bit is set. This network variable is only available if the Emergency interface is enabled (see Section 6.1.1.6).

nvoLampFail	
Type	SNVT_state_64
Valid Range	.bit0: 0, 1bit63: 0, 1
Default Value	-
Description	<p>This network variable reports the status of the lamps in the channel.</p> <p>Each bit corresponds to the ballast with the same index. In case the ballast indicates a lamp failure the bit is set.</p> <p>This network variable is only available if the Emergency interface is enabled (see Section 6.1.1.6).</p>

nvoBatteryFail	
Type	SNVT_state_64
Valid Range	.bit0: 0, 1bit63: 0, 1
Default Value	-
Description	<p>This network variable reports the battery status of the self-contained emergency lights in the channel.</p> <p>Each bit corresponds to the ballast with the same index. In case the ballast indicates a battery failure the bit is set. Note, that this function is not supported by all types of self-contained emergency lights.</p> <p>This network variable is only available if the Emergency interface is enabled (see Section 6.1.1.6).</p>

nvoFuncTestFail	
Type	SNVT_state_64
Valid Range	.bit0: 0, 1bit63: 0, 1
Default Value	-
Description	<p>This network variable reports the result of the last function test performed by each self-contained emergency light in the channel.</p> <p>Each bit corresponds to the ballast with the same index. In case the ballast indicates a failed function test the bit is set. Note, that this function is not supported by all types of self-contained emergency lights.</p> <p>This network variable is only available if the Emergency interface is enabled (see Section 6.1.1.6).</p>

nvoDurTestFail	
Type	SNVT_state_64
Valid Range	.bit0: 0, 1bit63: 0, 1
Default Value	-
Description	This network variable reports the result of the last duration test performed by each self-contained emergency light in the channel. Each bit corresponds to the ballast with the same index. In case the ballast indicates a failed duration test the bit is set. Note, that this function is not supported by all types of self-contained emergency lights. This network variable is only available if the Emergency interface is enabled (see Section 6.1.1.6).

6.1.1.14 Configuration Properties

All configuration properties listed in this section are implemented as Configuration Parameters using configuration files (CPT, CPV, and CPC files). File access is provided via LONMARK FTP.

nciLocation	
Type	SCPTLocation (SNVT_str_asc)
Valid Range	31 ASCII characters
Default Value	Lamp X/Group X/Channel X
Description	This configuration property can be used to specify the name of the lamp/group/channel.

nciRunHrInit	
Type	SCPTrunHrInit (SNVT_elapsed_tm)
Valid Range	.day: 0..65534 .hour: 0..23 .minute: 0..59 .second: 0..59
Default Value	0
Description	This configuration property is used to store or reset the initial value of the run hours counter <i>nvoRunHours</i> (only for lamp actuator objects). To reset the value set it to its invalid value (all 0xFF).

nciEnCntInit	
Type	UCPTenrgyCntInit (SNVT_elec_whr_f)
Valid Range	0..3.40282E38 Wh
Default Value	0
Description	This configuration property is used to store or reset the initial value of the energy counter <i>nvoEnergyCnt</i> (only for a lamp actuator objects). To reset the value set it to its invalid value (NaN).

nciGroups	
Type	UCPTgroups (SNVT_state)
Valid Range	.bit0: 0, 1bit15: 0, 1
Default Value	0
Description	This configuration property defines the group membership of a lamp. Each bit corresponds to the group of the same index. If the bit is set, the lamp is member of the group.

nciOnDelay	
Type	UCPTonDelay (SNVT_time_sec)
Valid Range	0..6553.4 sec Resolution: 0.1 sec
Default Value	0
Description	This configuration property determines the delay after which the lamp value output is switched on.

nciOffDelay	
Type	UCPTOffDelay (SNVT_time_sec)
Valid Range	0..6553.4 sec Resolution: 0.1 sec
Default Value	0
Description	This configuration property determines the delay after which the lamp value output is switched off.

nciAutoOffDelay	
Type	UCPTautoOffDelay (SNVT_time_sec)
Valid Range	0..6553.4 sec Resolution: 0.1 sec 0s means disabled (no delay)
Default Value	0
Description	This configuration property determines the delay after which the lamp output is switched off automatically. The timer is started after receiving a lamp ON command via the <i>nviXXValue</i> or <i>nviXXSetting</i> network variable inputs. The configuration properties <i>nciAutoOffRestart</i> and <i>nciAutoOffBreak</i> modify the behavior of the auto-off timer.

nciAutoOffRestart							
Type	UCPTautoOffRestart (SNVT_lev_disc)						
Valid Range	ST_ON, ST_OFF						
Default Value	ST_OFF						
Description	<p>This configuration property determines if the auto off timer can be restarted by an ON command via the <i>nviXXValue</i> or <i>nviXXSetting</i> network variable inputs.</p> <table border="1"> <thead> <tr> <th>Function</th> <th>Description</th> </tr> </thead> <tbody> <tr> <td>ST_ON</td> <td>While the auto-off timer is running, the timer can be restarted by an ON command via the <i>nviXXValue</i> or <i>nviXXSetting</i> network variable inputs.</td> </tr> <tr> <td>ST_OFF</td> <td>While the auto-off timer is running, all ON command via the <i>nviXXValue</i> or <i>nviXXSetting</i> network variable inputs are ignored.</td> </tr> </tbody> </table>	Function	Description	ST_ON	While the auto-off timer is running, the timer can be restarted by an ON command via the <i>nviXXValue</i> or <i>nviXXSetting</i> network variable inputs.	ST_OFF	While the auto-off timer is running, all ON command via the <i>nviXXValue</i> or <i>nviXXSetting</i> network variable inputs are ignored.
Function	Description						
ST_ON	While the auto-off timer is running, the timer can be restarted by an ON command via the <i>nviXXValue</i> or <i>nviXXSetting</i> network variable inputs.						
ST_OFF	While the auto-off timer is running, all ON command via the <i>nviXXValue</i> or <i>nviXXSetting</i> network variable inputs are ignored.						

nciAutoOffBreak							
Type	UCPTautoOffBreak (SNVT_lev_disc)						
Valid Range	ST_ON, ST_OFF						
Default Value	ST_OFF						
Description	<p>This configuration property determines if the auto off timer can be aborted prematurely by an OFF command via the <i>nviXXValue</i> or <i>nviXXSetting</i> network variable inputs.</p> <table border="1"> <thead> <tr> <th>Function</th> <th>Description</th> </tr> </thead> <tbody> <tr> <td>ST_ON</td> <td>While the auto-off timer is running, the timer can be aborted prematurely by an OFF command via the <i>nviXXValue</i> or <i>nviXXSetting</i> network variable inputs.</td> </tr> <tr> <td>ST_OFF</td> <td>While the auto-off timer is running, all OFF command via the <i>nviXXValue</i> or <i>nviXXSetting</i> network variable inputs are ignored.</td> </tr> </tbody> </table>	Function	Description	ST_ON	While the auto-off timer is running, the timer can be aborted prematurely by an OFF command via the <i>nviXXValue</i> or <i>nviXXSetting</i> network variable inputs.	ST_OFF	While the auto-off timer is running, all OFF command via the <i>nviXXValue</i> or <i>nviXXSetting</i> network variable inputs are ignored.
Function	Description						
ST_ON	While the auto-off timer is running, the timer can be aborted prematurely by an OFF command via the <i>nviXXValue</i> or <i>nviXXSetting</i> network variable inputs.						
ST_OFF	While the auto-off timer is running, all OFF command via the <i>nviXXValue</i> or <i>nviXXSetting</i> network variable inputs are ignored.						

nciOffWarningDly	
Type	UCPToffWarningDly (SNVT_time_sec)
Valid Range	0..6553.4 sec Resolution: 0.1 sec 0s means disabled (no delay)
Default Value	0
Description	<p>This configuration property defines the time during which the user will be notified that the light will be switched off shortly. During this time, the light is dimmed to 50% of the current level. Lamps which cannot be dimmed (<i>nciMinLevel</i> = <i>nciMaxLevel</i>) blink during this time.</p>

nciMinLevel	
Type	UCPTminLevel (SNVT_lev_cont)
Valid Range	0..100% Resolution: 0.5
Default Value	0.1%
Description	This configuration property specifies the minimum dim level of a lamp. Corresponds to the DALI-Register MIN LEVEL.

nciMaxLevel	
Type	UCPTmaxLevel (SNVT_lev_cont)
Valid Range	0..100% Resolution: 0.5
Default Value	100%
Description	This configuration property specifies the maximum dim level of a lamp. Corresponds to the DALI-Register MAX LEVEL.

nciPowerUpLev	
Type	UCPTpowerUpLevel (SNVT_lev_cont)
Valid Range	0..100% (for some ballasts 0% is not allowed) Resolution: 0.5
Default Value	100%
Description	Initial dim level of DALI lamp after power has been applied to lamp. Corresponds to the DALI-Register POWER ON LEVEL.

nciSysFailurLev	
Type	UCPTsysFailureLevel (SNVT_lev_cont)
Valid Range	0..100% Resolution: 0.5 255/invalid value means keep current dim level
Default Value	100%
Description	This configuration property determines the dim value of a DALI lamp in case of a DALI system failure. Corresponds to the DALI-Register SYSTEM FAILURE LEVEL.

nciFadeRate	
Type	UCPTfadeRate
Valid Range	2.8..360 steps/s
Default Value	45 steps/s
Description	This configuration property determines the fade rate of a lamp in percent per second in ramping mode. Corresponds to the DALI-Register FADE RATE.

nciFadeTime	
Type	UCPTfadeTime (SNVT_time_sec)
Valid Range	0..100 sec
Default Value	0 sec
Description	This configuration property determines the duration of a fade time in fading mode. Corresponds to the DALI-Register FADE TIME.

nciNominalPwr	
Type	UCPTnominalPwr (SNVT_power)
Valid Range	0..6553.5 W Resolution: 0.1 W 0 means AUTO
Default Value	AUTO
Description	This configuration property specifies the nominal power of the lamp. It is used to calculate the energy consumption. Some DALI ballasts can report their nominal power. In this case the configuration property should be set to 0 (AUTO).

nciEmTestDelay	
Type	UCPTtestDelay (SNVT_time_sec)
Valid Range	0..6553.4 sec Resolution: 0.1 sec
Default Value	0
Description	This configuration property is used for the emergency light test which is started by the network variable input <i>nviEmergTest</i> . It defines the time after which the dim level of the emergency lamps is compared with the reference value <i>nciEmTestValue</i> .

nciEmTestValue	
Type	UCPTtestValue (SNVT_lev_cont)
Valid Range	0..100% Resolution: 0.5
Default Value	0
Description	This configuration property is used for the emergency light test which is started by the network variable input <i>nviEmergTest</i> . It defines the reference value to which the dim level of the emergency lamps will be compared.

nciBurnInTime	
Type	UCPTburnInTime (SNVT_time_hour)
Valid Range	0..65,535 h
Default Value	100 h
Description	This configuration defines the burn-in time for new lamp. The burn-in mode is started via the network variable input <i>nviCommand</i> .

nciDaliCfg	
Type	UCPTdaliCfg
Valid Range	-
Default Value	-
Description	This configuration property contains the device type specific DALI-Registers. It is only available if the device type of a device is known, either because it was assigned or because the device type was set in the DALI Installation tab.

6.1.2 Light Sensor Object #1010

The L-DALI provides 16 light sensor objects for each DALI channel. A light sensor object makes the measured lux level of a DALI light sensor available on the CEA-709 network.

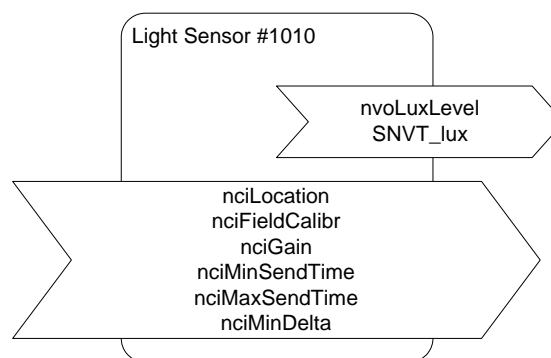

Figure 70: Light Sensor Object

This object type is enabled in the default interface. It can be disabled (together with the Occupancy Sensor objects).

6.1.2.1 Sensor Calibration

To provide a reliable measurement the light sensor needs to be calibrated. The calibration is best performed with the LINX Configurator software (see LINX Configurator User Manual [2]) or using the Web Interface (see LOYTEC Device User Manual [1]).

6.1.2.2 Output Network Variables

nvoLuxLevel	
Type	SNVT_lux
Valid Range	0..65,335 lux
Default Value	0
Description	This network variable provides the lux level measured by the light sensor. If no corresponding light sensor is present on the DALI network the value is 0.

6.1.2.3 Configuration Properties

All configuration properties listed in this section are implemented as Configuration Parameters using configuration files (CPT, CPV, and CPC files). File access is provided via LONMARK FTP.

nciLocation	
Type	SCPTLocation (SNVT_str_asc)
Valid Range	31 ASCII characters
Default Value	Sensor X
Description	This configuration property can be used to specify the name of the light sensor.

nciFieldCalibr	
Type	UCPTfieldCalibArray
Valid Range	.index: 0..6 .value: 0..65,535 lux
Default Value	0/0
Description	<p>This configuration property is used to calibrate the light sensor. To counter any non-linearity the sensor can be calibrated under up to seven different illumination levels (table with index 0-6).</p> <p>The <i>.index</i> field specifies the index into the gain table (<i>nciGain</i>) for different illumination levels.</p> <p>The <i>.value</i> field is used to specify the lux value measured with an external luxmeter. It is used together with the lux value reported by the sensor to compute the corresponding entry in the gain table.</p> <p>When reading the value from the device (CP upload) the value 0/0 will be returned. Writing this value will be ignored. This protects the calibration values from accidentally being overwritten during (re-)commissioning.</p>

nciGain	
Type	UCPTgainArray
Valid Range	.gain_mul[7]: 0..65,535 lux .gain_div[7]: 0..65,535 lux
Default Value	All 0/0.
Description	<p>This configuration property is used to store the calibration data.</p> <p>.gain_mul[i] contains the lux value measured by a luxmeter.</p> <p>.gain_div[i] contains the lux value measured by the light sensor.</p> <p>Default values 0/0 are ignored.</p>

nciMinSendTime	
Type	SCPTminSendTime (SNVT_time_sec)
Valid Range	0..6553.4 sec Resolution: 0.1 sec
Default Value	1.0 sec
Description	Minimum time between updates of the <i>nvoLuxLevel</i> output.

nciMaxSendTime	
Type	SCPTmaxSendTime (SNVT_time_sec)
Valid Range	0..6553.4 sec Resolution: 0.1 sec
Default Value	60.0 sec
Description	Maximum time between updates of the <i>nvoLuxLevel</i> output (heartbeat functionality).

nciMinDelta	
Type	SCPTminDeltaLevel (SNVT_lev_cont)
Valid Range	0..100% Resolution: 0.5
Default Value	2.5%
Description	This configuration property specifies the amount by which the lux level must change before <i>nvoLuxLevel</i> is updated.

6.1.3 Occupancy Sensor Object #1060

The L-DALI provides 16 occupancy sensor objects for each DALI channel. The occupancy sensor object makes the state of a DALI occupancy sensor available on the CEA-709 network.

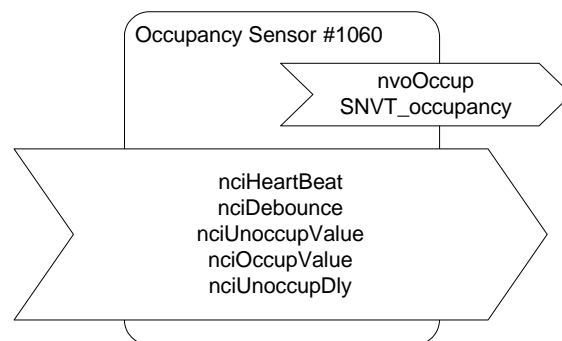

Figure 71: Occupancy Sensor Object.

This object type is enabled in the default interface. It can be disabled (together with the Light Sensor objects).

6.1.3.1 Timing Description

The timing diagram shown in Figure 72 defines the different timers used by the occupancy sensor object.

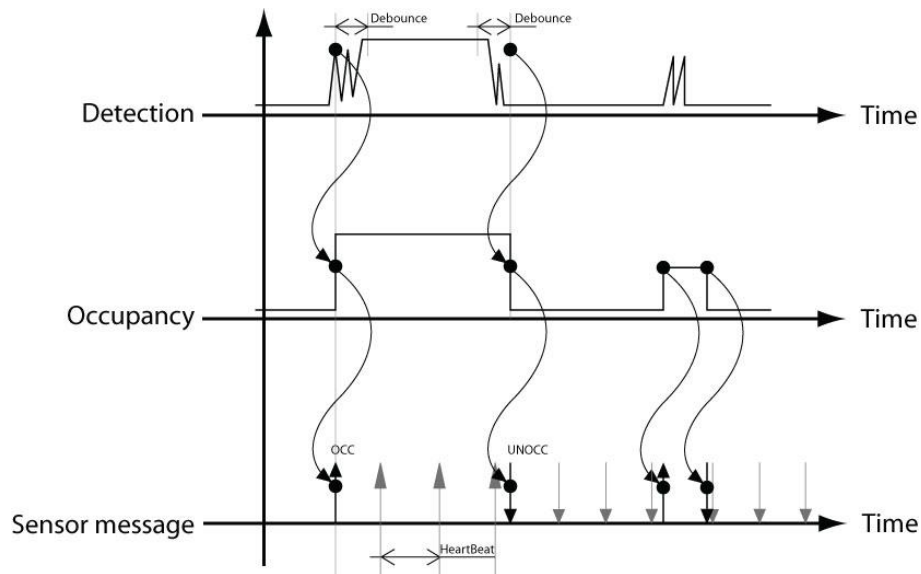

Figure 72: Timing of occupancy detection.

6.1.3.2 Output Network Variables

nvoOccup	
Type	SNVT_occupancy
Valid Range	OC_NUL (-1): Invalid Value OC_OCCUPIED (0): Area is occupied OC_UNOCCUPIED (1): Area is unoccupied OC_BYPASS (2): Area is temporarily occupied for the bypass period OC_STANDBY (3): Area is temporarily unoccupied
Default Value	OC_NUL
Description	This network variable provides the occupancy state measured by the occupancy sensor. If no corresponding occupancy sensor is present on the DALI network the value is OC_NUL.

6.1.3.3 Configuration Properties

All configuration properties listed in this section are implemented as Configuration Parameters using configuration files (CPT, CPV, and CPC files). File access is provided via LONMARK FTP.

nciHeartBeat	
Type	SCPTheartbeat (SNVT_time_sec)
Valid Range	0..6553.4 sec Resolution: 0.1 sec
Default Value	120.0 sec
Description	Maximum period of time that expires before the object automatically transmits the present value of the <i>nvoOccup</i> output NV.

nciDebounce	
Type	SCPTdebounce (SNVT_time_sec)
Valid Range	0..6553.4 sec Resolution: 0.1 sec
Default Value	0 sec
Description	Debouncing time to generate the detection envelope for occupancy detection and the OCCUPIED and NON OCCUPIED message.

nciUnoccupValue	
Type	UCPTunoccupiedValue (SNVT_occupancy)
Valid Range	OC_NUL (-1): Invalid Value OC_OCCUPIED (0): Area is occupied OC_UNOCCUPIED (1): Area is unoccupied OC_BYPASS (2): Area is temporarily occupied for the bypass period OC_STANDBY (3): Area is temporarily unoccupied
Default Value	OC_UNOCCUPIED
Description	This configuration property defines what value is transmitted via <i>nvoOccup</i> when the sensor detects that the room is unoccupied.

nciOccupValue	
Type	UCPToccupiedValue (SNVT_occupancy)
Valid Range	OC_NUL (-1): Invalid Value OC_OCCUPIED (0): Area is occupied OC_UNOCCUPIED (1): Area is unoccupied OC_BYPASS (2): Area is temporarily occupied for the bypass period OC_STANDBY (3): Area is temporarily unoccupied
Default Value	OC_OCCUPIED
Description	This configuration property defines what value is transmitted via <i>nvoOccup</i> when the sensor detects that the room is occupied.

nciUnoccupDly	
Type	UCPTunoccupDly (SNVT_time_sec)
Valid Range	0..6553.4 sec Resolution: 0.1 sec 0s means disabled (no delay)
Default Value	0 sec
Description	This configuration property specifies the delay after which <i>nvoOccup</i> adopts the unoccupied value. The timer is started when the occupancy sensor detects that the room is unoccupied

6.1.4 Constant Light Controller Object #3050

The L-DALI provides 16 constant light controller objects with built in occupancy controller functionality for each DALI channel.

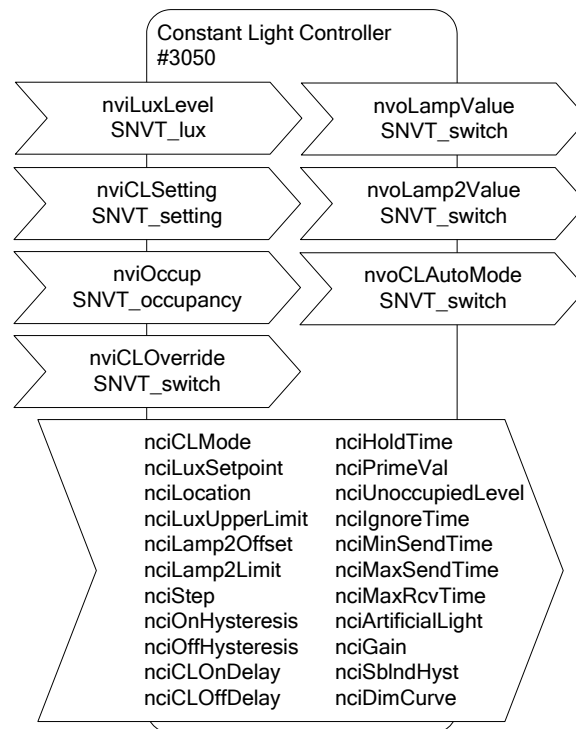

Figure 73: Constant Light Controller Object

This object type is enabled in the default interface. It can be disabled.

6.1.4.1 Interaction with other LONMARK Objects

To minimize the number of bindings that have to be created the constant light controller uses default connections to the local light sensor, occupancy sensor, and group objects in case no “real” bindings are done. This function is referred to as **Automatic Internal Bindings**. Figure 74 shows these default connections of the constant light controller object. Per default the constant light controller with index X controls the group object with index X. The current lux level is received from the light sensor object with index X and the occupancy state is received from the occupancy sensor X. The default connections can be changed by creating bindings with the network management tool. A detailed description under which conditions the default connections apply is given in Table 7.

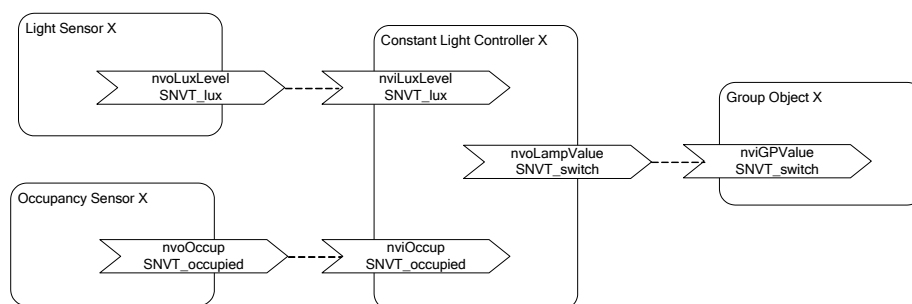

Figure 74: Default Connections to other LONMARK Objects

Per default automatic bindings are disabled. They can be enabled using the project settings in the LINX Configurator software (see LINX Configurator User Manual [2]) or the Web-Interface (see Section 6.3.1).

Default Connection	Condition
Lux Level	The default connection applies if the following network variables are not bound: <ul style="list-style-type: none"> • <i>nviLuxLevel</i> (Constant Light Controller X) • <i>nviOccup</i> (Constant Light Controller X)
Occupancy State	The default connection applies if the following network variables are not bound: <ul style="list-style-type: none"> • <i>nviLuxLevel</i> (Constant Light Controller X) • <i>nviOccup</i> (Constant Light Controller X)
Lamp Value	The default connection applies if the following network variables are not bound: <ul style="list-style-type: none"> • <i>nvoLampValue</i> (Constant Light Controller X) • <i>nviGPValue</i> (Group Object X) • <i>nviGPSetting</i> (Group Object X) • <i>nviGPOverride</i> (Group Object X) • <i>nviGPScene</i> (Group Object X)

Table 7: Default Connections for Automatic Internal Bindings.

When using local DALI sensors and/or DALI groups internal manual CLC bindings can be configured in the DALI Parameters tab of the LINX Configurator software (see LINX Configurator User Manual [2]) or the Web-Interface (see Section 6.3.1). The Web-Interface for CLC Bindings can also be used to verify the current status of all bindings (internal and NVs).

6.1.4.2 Setpoint

The desired setpoint for the illumination level is configured via the configuration property *nciLuxSetpoint*. The input network variable *nviCLSetting* of type SNVT_setting switches the constant light controller on or off. Furthermore this network variable can be used to temporarily adjust the setpoint.

6.1.4.3 Operating Modes

The operating mode of the constant light controller is set via the configuration property *nciCLMode*. Table 8 shows the different operating modes and under which conditions they are used:

Operating Mode	Description
REGULATOR	A light sensor that measures the indoor illumination is installed. An occupancy sensor is installed.
REGULATOR_NO_OCC	A light sensor that measures the indoor illumination is installed. No occupancy sensor is installed.
REGULATOR_AUTO	Similar to REGULATOR, but a manual override is automatically relinquished when the room becomes unoccupied.
REGULATOR_BEDROOM	Similar to REGULATOR_AUTO, but a manual override is not automatically relinquished when the lights are overridden to off.
REGULATOR_MANUAL	Similar to REGULATOR, but the automatic mode must be manually activated (e.g. via a button, not triggered by occupancy). Lights are switched off and automatic mode is disabled when turning unoccupied.
REGULATOR_MANUAL_LUX	Similar to REGULATOR_MANUAL, but the automatic mode is disabled, whenever lights are switched off, either due to becoming unoccupied or due to enough natural light being available.
REGULATOR_NO_MANUAL	Similar to REGULATOR, but ignoring overrides via buttons or other DALI masters (see Section 6.1.4.10).
CONTROL	A light sensor that measures the outdoor illumination is installed. An occupancy sensor is installed.
CONTROL_NO_OCC	A light sensor that measures the outdoor illumination is installed. No occupancy sensor is installed.
CONTROL_AUTO	Similar to CONTROL, but a manual override is automatically relinquished when the room becomes unoccupied.
CONTROL_BEDROOM	Similar to CONTROL_AUTO, but a manual override is not automatically relinquished when the lights are overridden to off.
CONTROL_MANUAL	Similar to CONTROL, but the automatic mode must be manually activated (e.g. via a button, not triggered by occupancy). Lights are switched off and automatic mode is disabled when turning unoccupied.
CONTROL_MANUAL_LUX	Similar to CONTROL_MANUAL, but the automatic mode is disabled, whenever lights are switched off, either due to becoming unoccupied or due to enough natural light being available.
CONTROL_NO_MANUAL	Similar to CONTROL, but ignoring overrides via buttons or other DALI masters (see Section 6.1.4.10).
PRESENCE	Based on occupancy the lights shall be switched on and off.
PRESENCE_AUTO	Similar to PRESENCE, but a manual override is automatically relinquished when the room becomes unoccupied.
PRESENCE_NO_MANUAL	Similar to PRESENCE, but ignoring overrides via buttons or other DALI masters (see Section 6.1.4.10).
MANUAL_ON_AUTO_OFF	Lights are switched on manually, but shall be switched off when the room becomes unoccupied.
AMBIENT	Effect or ambient lighting is switched on based on the measured illumination level.

Operating Mode	Description
UPDATER	A DALI sensor with constant light controller functionality shall be mapped to the CEA-709 network. Only the setpoint shall be adjustable via the CEA-709 interface.

Table 8: Constant Light Controller Operation Modes

Regulator Mode

The REGULATOR mode has to be selected if the installed light sensor measures the indoor brightness. The constant light controller receives the current indoor lux level via the input network variable *nviLuxLevel* and adjusts the lamp level (from 0% to 100%) by means of a fuzzy control algorithm.

When the light is switched on the control algorithm selects a lamp value which results in a lux level close to the desired setpoint and then adjusts the lamp value in increments once every second until the configured setpoint is reached. The size of increments is adjusted dynamically but will never exceed the percentage value defined in the configuration property *nciStep*.

The regulator mode is available in different flavors:

- **With our without occupancy sensor:** If an occupancy sensor is installed and the room becomes unoccupied, the current light level is saved and the light is dimmed to unoccupied level (see Section 6.1.4.8). If the room becomes occupied before the light has reached the unoccupied level, the saved light level is restored.
- **With automatic relinquish:** Any manual override will be automatically relinquished when the room becomes unoccupied. In a special bedroom mode the automatic relinquish will only take place if the lights are on. If they were switched off manually, the controller does not return to automatic mode when the area turns unoccupied.
- **With manual activation:** In this flavor, the automatic lighting control must be manually activated (e.g. via a button) and lights will not be switched on automatically when the room becomes occupied. To give the user some visual feedback lights will be switched on, even if the light level in the room is above the setpoint, whenever the automatic mode is activated (either via a data point or via a DALI button). When the room becomes unoccupied the automatic mode is deactivated. In the REGULATOR_MANUAL_LUX flavor, the automatic mode is deactivated whenever lights are switched off (e.g. due to the natural light being above the setpoint).

Control Mode

The CONTROL mode has to be selected if the installed light sensor measures the outdoor illumination. The constant light controller receives the current outdoor lux level via the input network variable *nviLuxLevel* and sets the lamp level (from 0% to 100%) accordingly (see Figure 75).

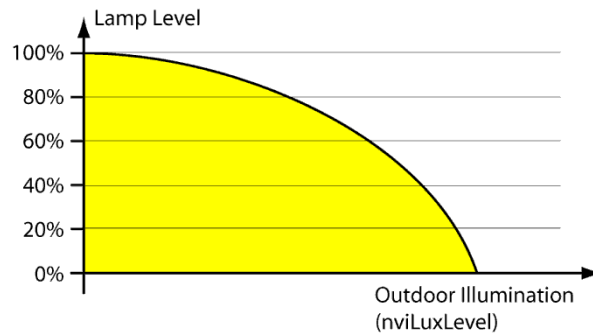

Figure 75: Control Mode

The configuration property *nciStep* ensures that the light level does not change abruptly. Per second the light level is not changed more than the percentage value defined by this configuration property. When the light is switched on or off, *nciStep* is not taken into account.

To ensure that the setpoint is reached under all weather conditions, the control curve shown Figure 75 has to be adjusted by calibrating the constant light controller. The calibration of the constant light controller is best performed with the LINX Configurator software (DALI Parameters tab, see LINX Configurator User Manual [2]).

The control mode is available in different flavors:

- **With our without occupancy sensor:** If an occupancy sensor is installed and the room becomes unoccupied, the current light level is saved and the light is dimmed to unoccupied level (see Section 6.1.4.8). If the room becomes occupied before the light has reached the unoccupied level, the saved light level is restored.
- **With automatic relinquish:** Any manual override will be automatically relinquished when the room becomes unoccupied. In a special bedroom mode the automatic relinquish will only take place if the lights are on. If they were switched off manually, the controller does not return to automatic mode when the area turns unoccupied.
- **With manual activation:** In this flavor, the automatic lighting control must be manually activated (e.g. via a button) and lights will not be switched on automatically when the room becomes occupied. To give the user some visual feedback lights will be switched on, even if the light level in the room is above the setpoint, whenever the automatic mode is activated (either via a data point or via a DALI button). When the room becomes unoccupied the automatic mode is deactivated. In the CONTROL_MANUAL_LUX flavor, the automatic mode is deactivated whenever lights are switched off (e.g. due to the natural light being above the setpoint).

Presence Mode

The PRESENCE mode has to be if the constant light controller shall operate as occupancy controller. In this mode the light is switched to the value *nciPrimeVal* if the room is occupied and to the unoccupied level (see Section 6.1.4.8) once the room becomes unoccupied.

If the network variable input *nviLuxLevel* is bound, the light is switched to the value *nciPrimeVal* only if the lux level is below *nciLuxSetpoint* and the room is occupied.

The presence mode is available in different flavors:

- **With or without automatic relinquish:** If automatic relinquish is active any manual override will be automatically relinquished when the room becomes unoccupied.

Manual-On/Auto-Off Mode

The MANUAL_ON_AUTO_OFF mode is a variation of the PRESENCE mode. However, in this mode the constant light controller does not switch on the lights, when the room becomes occupied. Rather, it switches the lights to the unoccupied level (see Section 6.1.4.8) when the room becomes unoccupied, using *nciHoldTime* similar to PRESENCE mode.

Lights can be switched on (or off) using *nviCLOverride* or *nviCLSetting* or via some other DALI master (e.g. a DALI push-button).

Ambient Mode

The AMBIENT mode is used if effect lighting (e.g. lights in a shop window, facade lighting, floor lights etc.) has to be switched on or off depending on a measured light level. Lights are switched to the value *nciPrimeVal* when the *nviLuxLevel* is below *nciLuxSetpoint* and to the unoccupied level (see Section 6.1.4.8) when *nviLuxLevel* is higher than *nciLuxSetpoint*.

Updater Mode

The UPDATER mode has to be selected when a DALI light/occupancy sensor with constant light controller functionality is installed on the DALI network. In this mode no light level computation is performed. The controller simply forwards the parameters to the DALI constant light controller and retrieves lamp setting from the DALI light sensor.

In general, LOYTEC does not recommend using UPDATER mode. Wherever possible use REGULATOR or CONTROL mode instead and use DALI sensors only as lux level and occupancy information source via the corresponding sensor objects. These modes allow improved influence of the constant light controller's parameters via the fieldbus side.

6.1.4.4 Prioritized Control

The network variable input *nviCLOverride* can be used to override the constant light controller algorithm. Valid (*.state=0/1*) values received on this inputs are directly passed to the *nvoLampValue* output.

Similar an override is possible via the network variable input *nviCLSetting* when setting the *.function* field to SET_OFF or to SET_STATE. When using SET_STATE the value of the *.setting* field is directly passed to the *nvoLampValue* output.

When internal CLC bindings are used to control DALI groups an override can also be performed using a DALI push-button device controlling the same groups as the constant light controller (see Section 6.1.4.10) or with a scene recall on those groups.

To return to automatic mode the following options exist:

- Set the *.state* field of *nviCLOverride* to -1 (invalid).
- Set the *.function* field of *nviCLSetting* to SET_ON.
- Recalling the scene 255 on the lamp actuator object of a group linked to the constant light controller (see Section 6.1.1.1).
- Using the button function AUTO of a DALI push-button (e.g. LDALI-BM1) with the destination set to one of the constant light controllers groups (see Section 6.1.4.10).

- When using one of the modes with automatic override relinquish (xxx_AUTO or xxx_BEDROOM) the constant light controller will return to automatic mode when it changes its state to unoccupied.

Whether the constant light controller is in automatic mode or in manual/override mode is reflected by the network variable output *nvoCLAutoMode*.

6.1.4.5 Controlling Multiple Light Bands

The L-DALI constant light controller allows controlling two light bands (groups). The primary light band is near the inside of the building, the secondary light band is near the window front. Depending on the outdoor light intensity the primary light band has to be brighter than the secondary light band to illuminate the room evenly.

The primary light band is controlled by the output network variable *nvoLampValue*, the secondary light band by the output network variable *nvoLamp2Value*. Further for both light bands internal bindings to local DALI groups and their corresponding Group Actuator objects can be configured in the DALI Parameters tab of the LINX Configurator software (see LINX Configurator User Manual [2]) or the Web-Interface (see Section 6.3.1).

The maximum difference between the two light bands can be configured via the configuration property *nciLamp2Offset* as shown in Figure 76. The configuration property *nciLamp2Limit* defines the light level above which the values of *nvoLampValue* and *nvoLamp2Value* are identical.

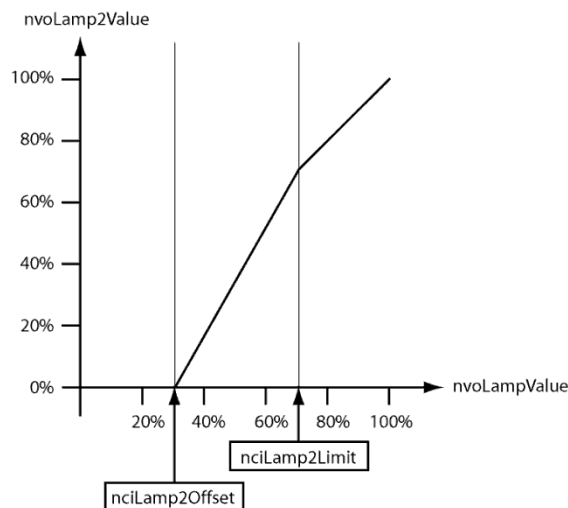

Figure 76: Secondary Light Band

6.1.4.6 Occupancy Detection

The constant light controller receives the occupancy information via the network variable input *nviOccup*.

If a hold time is configured (*nciHoldTime* > 0) occupancy evaluation is event based. That is, the constant light controller changes to the occupied state when the value OC_OCCUPIED is received. When the OC_UNOCCUPIED value is received the constant light controller remains in the occupied state until the hold time configured in *nciHoldTime* has expired and then changes to the unoccupied state. Further, if no OC_OCCUPIED is received for the time configured in *nciHoldTime* the constant light controller changes to the unoccupied state, too.

This behavior typically requires the occupancy sensor to send OC_OCCUPIED with a regular interval (heartbeat). It allows using multiple occupancy sensors with the same constant light controller (fan-in).

If no hold time is configured ($nciHoldTime = 0$) occupancy evaluation is state based. That is, the constant light controller changes to the occupied state when the value OC_OCCUPIED is received and to unoccupied state when the value OC_UNOCCUPIED is received.

This behavior is typically required if the occupancy information is only propagated if the state changes (no heartbeat functionality). It does not allow using multiple occupancy (fan-in) sensors without additional logic (e.g. an Occupancy Controller).

After the light has been switched off any updates on the $nviOccup$ input are ignored for the time specified in $nciIgnoreTime$.

The current occupancy state calculated by the constant light controller is available via the network variable $nvoCLOccupancyState$.

Note: The network variable $nvoCLOccupancyState$ is not part of the standard interface. It must be enabled in the CEA-709 project settings (see LINX Configurator User Manual [2]).

6.1.4.7 Timing Parameters

To avoid that the constant light controller switches the light on and off repeatedly if the measured lux value is near the setpoint, a hysteresis can be configured. The configuration parameter $nciOffHysteresis$ defines the hysteresis for switching off the lamp and the configuration property $nciOnHysteresis$ defines the hysteresis for switching on the lamp. In addition a delay can be configured before the lamp is switched on ($nciClOnDelay$) or off ($nciClOffDelay$). Figure 77 illustrates these configuration parameters.

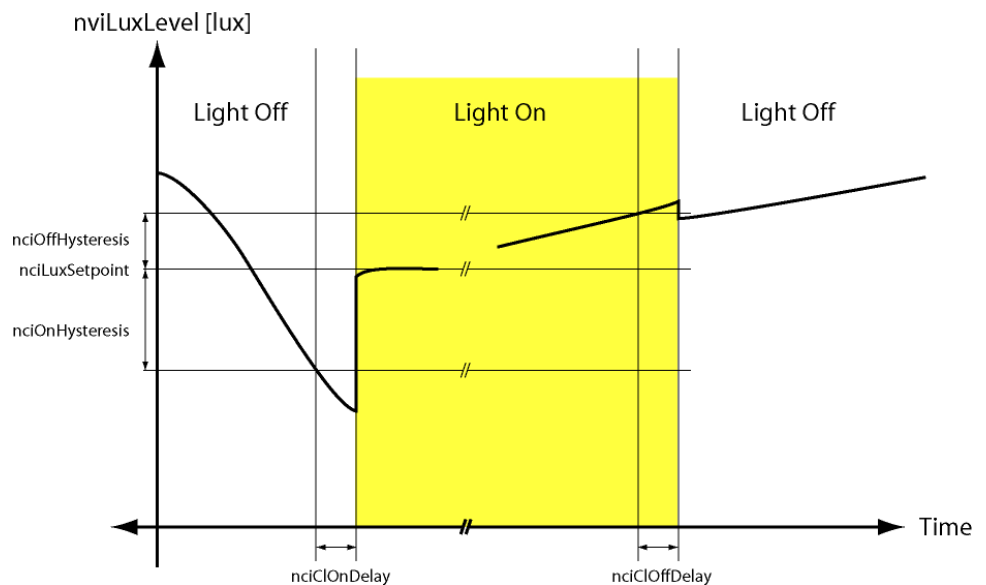

Figure 77: Constant Light Controller Timing

6.1.4.8 Unoccupied Level

If the constant light controller enters unoccupied state (see Section 6.1.4.6) $nciUnoccupiedLevel$ and $nciClOffDelay$ determine the behavior as shown in Table 9.

<i>nciUnoccupiedLevel</i>	<i>nciCLOffDelay</i>	Behavior
0	0	Dim down and switch off lights
> 0	0	Dim down lights to value defined in <i>nciUnoccupiedLevel</i> .
0	> 0	Dim down to 0.5% and switch off lights after <i>nciCLOffDelay</i> .
> 0	> 0	Dim down lights to value defined in <i>nciUnoccupiedLevel</i> and switch off lights after <i>nciCLOffDelay</i> .

Table 9: Behavior of constant light controller when entering unoccupied state.

6.1.4.9 Neighboring Controllers

In open office space applications, typically the different zones of the space are controlled by independent constant light controller instances. This ensures, that only the zones, which are still occupied are lit. To reduce the contrast between lit and unlit zones in case only a single zone is occupied amidst many unoccupied zones and to increase user comfort in such a scenario, unoccupied zones adjacent to occupied zones shall be lit up at a configurable low light level (*nciUnoccupiedLevel*).

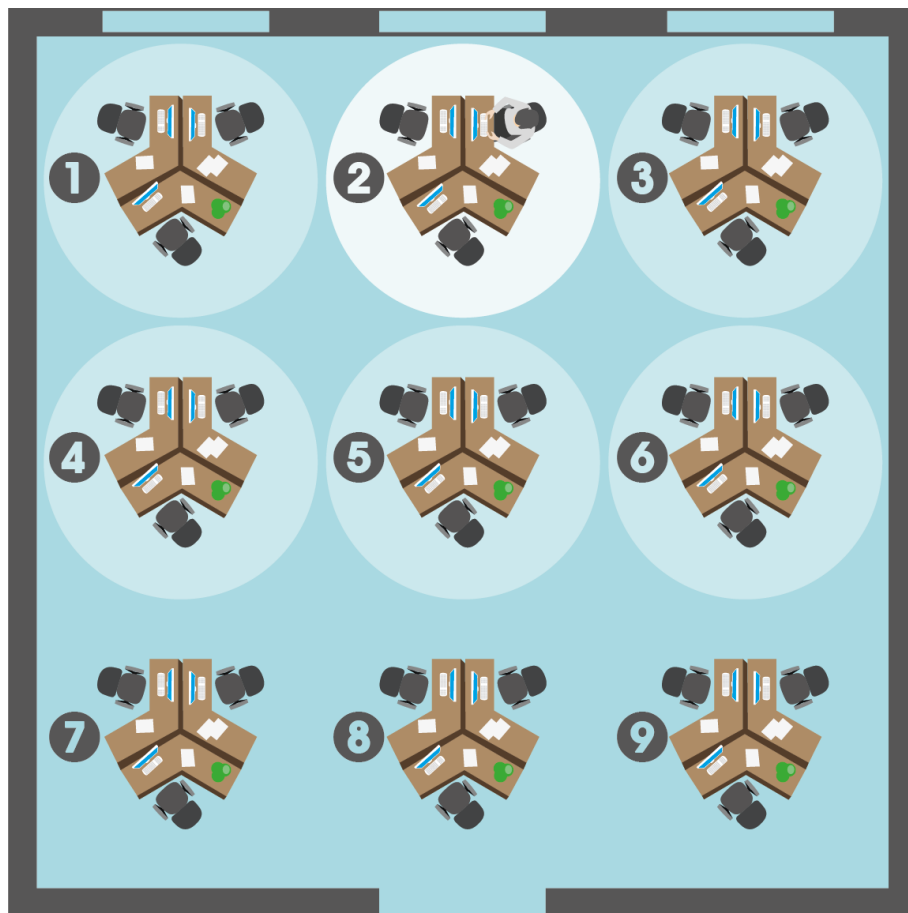

Figure 78: Different zones of an open office space.

Figure 78 shows an example of an open office space with nine zones controlled by independent constant light controller instances. In this example only zone 2 is occupied and fully lit. Zones 1 and 3 to 6 are configured as neighbors of zone 1 and therefore lit at a low dim level, while the remaining zones are switched off.

For this purpose each controller needs to know its neighboring controllers. A controller notifies the CLCs configured as neighbors whenever it switches its lights on. Now, the neighboring controllers, which are unoccupied, can switch to *nciUnoccupiedLevel*. Once the CLC switches lights off (e.g. because it becomes unoccupied) it again notifies the configured neighbors, which in turn can switch off as well.

For each CLC instance up to 16 neighbors can be configured. The neighboring controllers can be configured either via the CLC Bindings page in the web UI (see Section 6.3.1) or via the DALI parameters tab in the LINX Configurator (see LINX Configurator User Manual [2])

6.1.4.10 Interaction with Buttons Functions

When internal CLC bindings are used to control DALI groups an override can also be performed using a button function (see Section 6.3.3) or some other DALI master (like push-buttons etc.) controlling the same groups as the constant light controller.

Whenever the light level of one of the ballasts controlled by the constant light controller is changed by operating a button the constant light controller will detect this and stop controlling the group and enter override mode. Furthermore, the *nviCLOverride* and the *nvoLampValue* and *nvoLamp2Value* will be updated with the new feedback value of the group controlled by the button. See Section 6.1.4.4 on how to relinquish the override and return to automatic operation.

To disable the manual override via buttons and other DALI masters select the constant light controller operating mode `REGULATOR_NO_MANUAL`, `CONTROLLER_NO_MANUAL` or `PRESENCE_NO_MANUAL`, respectively. In this case the constant light controller application will continue control the group and enforce its output value.

See Section 6.3.3 on how to configure button functions via the web interface and the LINX Configurator User Manual [2] how to configure them via the DALI Parameters tab of the LINX Configurator software.

6.1.4.11 Interacting with Sunblind Controller

One or more local sunblind controller objects can be linked to a constant light controller object. Typically sunblind controllers are linked to the constant light controller of the same room. If they change the sunblind's position or rotation the sunblind controllers inform the linked constant light controller. The constant light controller uses this information to "ignore" temporary changes of the rooms illumination levels due to the moving sunblinds and, thus, can avoid to switch on lights unnecessarily.

6.1.4.12 Museum Mode

The museum mode is activated by setting an upper limit for the lux level in the room using the configuration property *nciLuxUpperLimit*. In museum mode the constant light controller cooperates with the linked sunblind controllers to ensure that the measured lux level stays between *nciLuxSetpoint* and *nciLuxUpperLimit*. Therefore at least one sunblind controller has to be linked to the constant light controller.

If the light intensity in the room needs to be increased to reach the lower setpoint (*nciLuxSetpoint*) there are two possibilities: Increase the lamp level or open the sunblinds. The configuration property *nciSblndHyst* defines how much the lamp level is increased or decreased before opening or closing the sunblinds respectively.

6.1.4.13 Set-Up Checklist

To get a working constant light controller object at least the following configuration steps have to be performed:

1. Bindings: If the constant light controller is not operated with its default auto-bindings (see Section 6.1.4.1) at least the following NVs have to be bound:
 - `nviOccup`
 - `nviLuxLevel`
 - `nvoLampValue`

Alternatively internal manual bindings can be configured in the DALI Parameters tab of the LINX Configurator software (see LINX Configurator User Manual [2]) or the Web-Interface (see Section 6.3.1). The Web-Interface for CLC Bindings can be used to verify the current status of all bindings (internal and NVs).

2. Mode: The operating mode of the constant light controller has to be configured using `nciCLMode` (see Section 6.1.4.3).
3. Disable override: Ensure no override is active via the NV `nviCLOverride` (see Section 6.1.4.4).

6.1.4.14 Input Network Variables

nviLuxLevel	
Type	SNVT_lux
Valid Range	0..65,335 lux
Default Value	-
Description	This network variable input provides the illumination level measured by the light sensor. If the variable is not bound, the <code>nvoLuxLevel</code> output of the light sensor object with the same instance number as the constant light controller is used.

nviCLSetting											
Type	SNVT_setting										
Valid Range	.function: SET_OFF (0): Override to off. SET_ON (1) Enable/Relinquish override. SET_DOWN (2) Decrease setpoint by specified value. SET_UP (3) Increase setpoint by specified value. SET_STATE (5) Override to specified value. .setting: 0..100, resolution 0.5 .rotation: not used										
Default Value											
Description	<p>This network variable input is used to enable (SET_ON) or disable (SET_OFF) the controller, to adjust the set point of the constant light controller (SET_UP and SET_DOWN) or to manually update the <i>nvoLampValue</i> and the <i>nvoLamp2Value</i> (SET_STATE).</p> <table border="1"> <thead> <tr> <th>Function</th> <th>Description</th> </tr> </thead> <tbody> <tr> <td>SET_OFF</td> <td>Deactivates the constant light controller and switches off the lamp value outputs <i>nvoLampValue</i> and <i>nvoLamp2Value</i>.</td> </tr> <tr> <td>SET_ON</td> <td>Activates the constant light controller. Relinquishes any override.</td> </tr> <tr> <td>SET_UP, SET_DOWN</td> <td>The set point of the controller can be increased (SET_UP) or decreased (SET_DOWN) temporarily. The <i>.setting</i> value is used to define the relative size of the increment/decrement. The changes made to the set point are not stored permanently into the memory. The next SET_ON command restored the original set point value (<i>nciLuxSetpoint</i>).</td> </tr> <tr> <td>SET_STATE</td> <td>Deactivates the constant light controller and sets <i>nvoLampValue</i> and <i>nvoLamp2Value</i> to the value specified in the <i>.setting</i> field (see Section 6.1.4.4). <i>nciLamp2Offset</i> and <i>nciLamp2Limit</i> are not considered.</td> </tr> </tbody> </table>	Function	Description	SET_OFF	Deactivates the constant light controller and switches off the lamp value outputs <i>nvoLampValue</i> and <i>nvoLamp2Value</i> .	SET_ON	Activates the constant light controller. Relinquishes any override.	SET_UP, SET_DOWN	The set point of the controller can be increased (SET_UP) or decreased (SET_DOWN) temporarily. The <i>.setting</i> value is used to define the relative size of the increment/decrement. The changes made to the set point are not stored permanently into the memory. The next SET_ON command restored the original set point value (<i>nciLuxSetpoint</i>).	SET_STATE	Deactivates the constant light controller and sets <i>nvoLampValue</i> and <i>nvoLamp2Value</i> to the value specified in the <i>.setting</i> field (see Section 6.1.4.4). <i>nciLamp2Offset</i> and <i>nciLamp2Limit</i> are not considered.
Function	Description										
SET_OFF	Deactivates the constant light controller and switches off the lamp value outputs <i>nvoLampValue</i> and <i>nvoLamp2Value</i> .										
SET_ON	Activates the constant light controller. Relinquishes any override.										
SET_UP, SET_DOWN	The set point of the controller can be increased (SET_UP) or decreased (SET_DOWN) temporarily. The <i>.setting</i> value is used to define the relative size of the increment/decrement. The changes made to the set point are not stored permanently into the memory. The next SET_ON command restored the original set point value (<i>nciLuxSetpoint</i>).										
SET_STATE	Deactivates the constant light controller and sets <i>nvoLampValue</i> and <i>nvoLamp2Value</i> to the value specified in the <i>.setting</i> field (see Section 6.1.4.4). <i>nciLamp2Offset</i> and <i>nciLamp2Limit</i> are not considered.										

nviOccup	
Type	SNVT_occupancy
Valid Range	OC_NUL (-1): Invalid Value OC_OCCUPIED (0): Area is occupied OC_UNOCCUPIED (1): Area is unoccupied OC_BYPASS (2): Ignored OC_STANDBY (3): Ignored
Default Value	OC_NUL
Description	<p>This network variable input provides the occupancy state measured by the occupancy sensor. If the variable is not bound, the <i>nvoOccup</i> output of the occupancy sensor object with the same instance number as the constant light controller is used.</p>

nviCLOverride	
Type	SNVT_switch
Valid Range	.value: 0..100% .state: 0, 1, -1 On: .state=1 and .value>0 Off: .state=0 and .value=0 Invalid: .state=-1
Default Value	
Description	This network variable input can be used to manually override the constant light controller (see Section 6.1.4.4). If a valid value is received (.state = 0/1), the constant light controller is disabled and <i>nvoLampValue</i> and <i>nvoLamp2Value</i> are set to the specified value. <i>nciLamp2Offset</i> and <i>nciLamp2Limit</i> are not considered. If an invalid value (.state -1) is received, the constant light controller returns to automatic mode. When performing an override via a DALI button the network variable will reflect the resulting feedback value of the group controlled by the DALI button (see Section 6.1.4.10).

6.1.4.15 Output Network Variables

nvoLampValue	
Type	SNVT_switch
Valid Range	.value: 0..100% .state: 0, 1, -1 On: .state=1 and .value>0 Off: .state=0 and .value=0 Invalid: .state=-1
Default Value	
Description	This network variable outputs provides the state (ON or OFF), and the percentage level of intensity for a lamp actuator. If the variable is not bound, the value is transmitted to the <i>nviGPValue</i> input of the DALI group object with the same instance number as the constant light controller.

nvoLamp2Value	
Type	SNVT_switch
Valid Range	.value: 0..100% .state: 0, 1, -1 On: .state=1 and .value>0 Off: .state=0 and .value=0 Invalid: .state=-1
Default Value	
Description	This network variable provides the state (ON or OFF), and the percentage level of intensity for the secondary light band. The value for the secondary light band (<i>nvoLamp2Value</i>) is set according to the configuration properties <i>nciLamp2Offset</i> and <i>nciLamp2Limit</i> .

nvoCLAutoMode	
Type	SNVT_switch
Valid Range	On: .state=1 and .value=100 Off: .state=0 and .value=0
Default Value	
Description	This network variable output provides the current state of the constant light controller. Off: The constant light controller is disabled or overridden by <i>nviCLOverride</i> or the DALI Mode button/LCD UI. On: The constant light controller is enabled and not overridden by <i>nviCLOverride</i> or the DALI Mode button/LCD UI.

nvoCLOccupState	
Type	SNVT_occupancy
Valid Range	OC_NUL (-1): Invalid Value OC_OCCUPIED (0): Area is occupied OC_UNOCCUPIED (1): Area is unoccupied
Default Value	
Description	This network variable output provides the current occupancy state calculated by the constant light controller (see Section 6.1.4.6). <i>Note: This network variable is not part of the standard interface. It must be enabled in the CEA-709 project settings (see LINX Configurator User Manual [2]).</i>

6.1.4.16 Configuration Properties

All configuration properties listed in this section are implemented as Configuration Parameters using configuration files (CPT, CPV, and CPC files). File access is provided via LONMARK FTP.

nciLocation	
Type	SCPTLocation (SNVT_str_asc)
Valid Range	31 ASCII characters
Default Value	Light Controller X
Description	This configuration property can be used to specify the name of the constant light controller

nciLuxSetpoint	
Type	SCPTluxSetpoint (SNVT_lux)
Valid Range	0..65,335 lux
Default Value	500 lux
Description	Defines the illumination level setpoint.

nciCLMode																									
Type	UCPTclMode (byte)																								
Valid Range	CL_MODE_DISABLED CL_MODE_REGULATOR CL_MODE_CONTROL CL_MODE_UPDATER CL_MODE_PRESENCE CL_MODE_REGULATOR_NO_OCC CL_MODE_CONTROL_NO_OCC CL_MANUAL_ON_AUTO_OFF CL_MODE_REGULATOR_AUTO CL_MODE_CONTROL_AUTO CL_MODE_PRESENCE_AUTO CL_MODE_AMBIENT CL_MODE_REGULATOR_BEDROOM CL_MODE_PRESENCE_BEDROOM CL_MODE_REGULATOR_MANUAL CL_MODE_REGULATOR_MANUAL_LUX CL_MODE_CONTROL_MANUAL CL_MODE_CONTROL_MANUAL_LUX																								
Default Value	CL_MODE_DISABLED																								
Description	<p>This configuration property defines the operating mode of the constant light controller.</p> <table border="1"> <thead> <tr> <th>Operating Mode</th> <th>Description</th> </tr> </thead> <tbody> <tr> <td>REGULATOR</td> <td>A light sensor that measures the indoor illumination is installed. An occupancy sensor is installed.</td> </tr> <tr> <td>REGULATOR_NO_OCC</td> <td>A light sensor that measures the indoor illumination is installed. No occupancy sensor is installed.</td> </tr> <tr> <td>REGULATOR_AUTO</td> <td>Similar to REGULATOR, but a manual override is automatically relinquished when the room becomes unoccupied.</td> </tr> <tr> <td>REGULATOR_BEDROOM</td> <td>Similar to REGULATOR_AUTO, but a manual override is not automatically relinquished when the lights are overridden to off.</td> </tr> <tr> <td>REGULATOR_MANUAL</td> <td>Similar to REGULATOR, but the automatic mode must be manually activated (e.g. via a button, not triggered by occupancy). Lights are switched off and automatic mode is disabled when turning unoccupied.</td> </tr> <tr> <td>REGULATOR_MANUAL_LUX</td> <td>Similar to REGULATOR_MANUAL, but the automatic mode is disabled, whenever lights are switched off, either due to becoming unoccupied or due to enough natural light being available.</td> </tr> <tr> <td>CONTROL</td> <td>A light sensor that measures the outdoor illumination is installed. An occupancy sensor is installed.</td> </tr> <tr> <td>CONTROL_NO_OCC</td> <td>A light sensor that measures the outdoor illumination is installed. No occupancy sensor is installed.</td> </tr> <tr> <td>CONTROL_AUTO</td> <td>Similar to CONTROL, but a manual override is automatically relinquished when the room becomes unoccupied.</td> </tr> <tr> <td>CONTROL_BEDROOM</td> <td>Similar to CONTROL_AUTO, but a manual override is not automatically relinquished when the lights are overridden to off.</td> </tr> <tr> <td>CONTROL_MANUAL</td> <td>Similar to CONTROL, but the automatic mode must be manually activated (e.g. via a button, not triggered by</td> </tr> </tbody> </table>	Operating Mode	Description	REGULATOR	A light sensor that measures the indoor illumination is installed. An occupancy sensor is installed.	REGULATOR_NO_OCC	A light sensor that measures the indoor illumination is installed. No occupancy sensor is installed.	REGULATOR_AUTO	Similar to REGULATOR, but a manual override is automatically relinquished when the room becomes unoccupied.	REGULATOR_BEDROOM	Similar to REGULATOR_AUTO, but a manual override is not automatically relinquished when the lights are overridden to off.	REGULATOR_MANUAL	Similar to REGULATOR, but the automatic mode must be manually activated (e.g. via a button, not triggered by occupancy). Lights are switched off and automatic mode is disabled when turning unoccupied.	REGULATOR_MANUAL_LUX	Similar to REGULATOR_MANUAL, but the automatic mode is disabled, whenever lights are switched off, either due to becoming unoccupied or due to enough natural light being available.	CONTROL	A light sensor that measures the outdoor illumination is installed. An occupancy sensor is installed.	CONTROL_NO_OCC	A light sensor that measures the outdoor illumination is installed. No occupancy sensor is installed.	CONTROL_AUTO	Similar to CONTROL, but a manual override is automatically relinquished when the room becomes unoccupied.	CONTROL_BEDROOM	Similar to CONTROL_AUTO, but a manual override is not automatically relinquished when the lights are overridden to off.	CONTROL_MANUAL	Similar to CONTROL, but the automatic mode must be manually activated (e.g. via a button, not triggered by
Operating Mode	Description																								
REGULATOR	A light sensor that measures the indoor illumination is installed. An occupancy sensor is installed.																								
REGULATOR_NO_OCC	A light sensor that measures the indoor illumination is installed. No occupancy sensor is installed.																								
REGULATOR_AUTO	Similar to REGULATOR, but a manual override is automatically relinquished when the room becomes unoccupied.																								
REGULATOR_BEDROOM	Similar to REGULATOR_AUTO, but a manual override is not automatically relinquished when the lights are overridden to off.																								
REGULATOR_MANUAL	Similar to REGULATOR, but the automatic mode must be manually activated (e.g. via a button, not triggered by occupancy). Lights are switched off and automatic mode is disabled when turning unoccupied.																								
REGULATOR_MANUAL_LUX	Similar to REGULATOR_MANUAL, but the automatic mode is disabled, whenever lights are switched off, either due to becoming unoccupied or due to enough natural light being available.																								
CONTROL	A light sensor that measures the outdoor illumination is installed. An occupancy sensor is installed.																								
CONTROL_NO_OCC	A light sensor that measures the outdoor illumination is installed. No occupancy sensor is installed.																								
CONTROL_AUTO	Similar to CONTROL, but a manual override is automatically relinquished when the room becomes unoccupied.																								
CONTROL_BEDROOM	Similar to CONTROL_AUTO, but a manual override is not automatically relinquished when the lights are overridden to off.																								
CONTROL_MANUAL	Similar to CONTROL, but the automatic mode must be manually activated (e.g. via a button, not triggered by																								

nciCLMode		
Type	UCPTclMode (byte)	
		occupancy). Lights are switched off and automatic mode is disabled when turning unoccupied.
	CONTROL_MANUAL_LUX	Similar to CONTROL_MANUAL, but the automatic mode is disabled, whenever lights are switched off, either due to becoming unoccupied or due to enough natural light being available.
	MANUAL_ON_AUTO_OFF	Lights are switched on manually, but shall be switched off when the room becomes unoccupied.
	PRESENCE	Based on occupancy the lights shall be switched on and off.
	PRESENCE_AUTO	Similar to PRESENCE, but a manual override is automatically relinquished when the room becomes unoccupied.
	AMBIENT	Effect or ambient lighting is switched on based on the measured illumination level (switching on ambient lights does not influence measured illumination level).
	UPDATER	A DALI sensor with constant light controller functionality shall be mapped to the CEA-709 network. Only the setpoint shall be adjustable via the CEA-709 interface.

nciLamp2Offset	
Type	UCPTlampOffset (SNVT_lev_cont)
Valid Range	0..100% Resolution: 0.5
Default Value	30%
Description	This configuration property defines the maximum offset between the output for the primary light band (<i>nvoLampValue</i>) and the secondary light band (<i>nvoLamp2Value</i>).

nciLamp2Limit	
Type	UCPTlampLimit (SNVT_lev_cont)
Valid Range	0..100% Resolution: 0.5
Default Value	70%
Description	This configuration property specifies the dim level at which the output for the secondary light band (<i>nvoLamp2Value</i>) becomes identical to the primary output (<i>nvoLampValue</i>).

nciStep	
Type	SCPTstep (SNVT_lev_cont)
Valid Range	0..100% Resolution: 0.5
Default Value	3%
Description	This configuration property defines the maximum step size that the constant light controller will take to approach the target illumination. Per second the light level is not changed more than the percentage value defined by this configuration property.

nciOnHysteresis	
Type	UCPTonHysteresis (SNVT_lev_cont)
Valid Range	0..100% Resolution: 0.5
Default Value	5%
Description	This configuration property defines the hysteresis for the input lux level as percentage of the setpoint for switching ON the lamp.

nciOffHysteresis	
Type	UCPToffHysteresis (SNVT_lev_cont)
Valid Range	0..100% Resolution: 0.5
Default Value	5%
Description	This configuration property defines the hysteresis for the input lux level as percentage of the setpoint for switching OFF the lamp.

nciMinSendTime	
Type	SCPTminSendTime (SNVT_time_sec)
Valid Range	0..6553.4 sec Resolution: 0.1 sec
Default Value	0.0 sec (disabled)
Description	Minimum time between updates of the <i>nvoLampValue</i> and <i>nvoLamp2Value</i> outputs.

nciMaxSendTime	
Type	SCPTmaxSendTime (SNVT_time_sec)
Valid Range	0..6553.4 sec Resolution: 0.1 sec
Default Value	300.0 sec
Description	Maximum time between updates of the <i>nvoLampValue</i> and <i>nvoLamp2Value</i> outputs (heartbeat functionality).

nciMaxRcvTime	
Type	SCPTmaxRcvTime (SNVT_time_sec)
Valid Range	0..6553.4 sec Resolution: 0.1 sec
Default Value	0.0 sec (disabled)
Description	This configuration property specifies the expected update interval of the <i>nviLuxLevel</i> network variable input. If the time elapses without an update of the variable an alarm is generated. If no update is received on <i>nviLuxLevel</i> for 10 intervals the <i>nvoLampValue</i> and <i>nvoLamp2Value</i> network variable outputs are set to 50%.

nciCLOffDelay	
Type	UCPTcIOffDelay (SNVT_time_sec)
Valid Range	0..6553.4 sec Resolution: 0.1 sec
Default Value	300.0 sec
Description	This configuration property specifies the delay after which the lamp value output (nvoLampValue/nvoLamp2Value) is switched off.

nciCLOnDelay	
Type	UCPTcIOnDelay (SNVT_time_sec)
Valid Range	0..6553.4 sec Resolution: 0.1 sec
Default Value	0.0 sec
Description	This configuration property specifies the delay after which the lamp value output (nvoLampValue/nvoLamp2Value) is switched on.

nciArtificialLight	
Type	UCPTartificialLight (SNVT_muldiv)
Valid Range	.multiplier: 0..65,335 lux .divisor: 0..65,335 lux
Default Value	0/0
Description	<p>This configuration property is used</p> <ul style="list-style-type: none"> to determine the ratio between a dim value and the amount of artificial light (in lux) corresponding to this dim value and if the light sensor has a different sensibility for artificial light then for natural light. <p>The default value of 0/0 results in an auto-calibration. Once auto-calibration has been performed the resulting artificial light factor is stored in the configuration property. Until the process is completed a default value is used.</p> <p>To manually determine the artificial light factor do the following:</p> <ul style="list-style-type: none"> Darken the room and set the lamp to the maximum value. Measure the lux value on the reference area with a luxmeter and with the light sensor. Then switch off the lamps and measure the lux value again with a luxmeter and the light sensor. Enter the difference of the lux measured by the luxmeter in <i>.multiplier</i> and the lux value difference measured by the light sensor in <i>.divisor</i>. <p>The value can be reset by setting the value to its invalid value (all 0xFF).</p>

nciGain	
Type	SCPTgain (SNVT_muldiv)
Valid Range	.multiplier: 0..65,335 lux .divisor: 0..65,335 lux
Default Value	1/1
Description	This configuration property is used to calibrate the light sensor. The configuration property is only needed if the light sensor does not have its own way of calibration. To calibrate the light sensor enter the lux value measured by a luxmeter in <i>.multiplier</i> and the lux value of the light sensor in <i>.divisor</i> . The lux level should be near the setpoint for best results. The value can be reset by setting the value to its invalid value (all 0xFF).

nciDimCurve	
Type	UCPTdimmingCurve
Valid Range	.used: 0, 1 .level_0: 0..100%, Resolution: 0.5 .level_1: 0..100%, Resolution: 0.5 .level_2: 0..100%, Resolution: 0.5 .level_3: 0..100%, Resolution: 0.5 .level_4: 0..100%, Resolution: 0.5 .level_5: 0..100%, Resolution: 0.5 .level_6: 0..100%, Resolution: 0.5 .level_7: 0..100%, Resolution: 0.5 .level_8: 0..100%, Resolution: 0.5 .level_9: 0..100%, Resolution: 0.5 .level_10: 0..100%, Resolution: 0.5
Default Value	.used = 0 .level_0 = 1% .level_1 = 1.5% .level_2 = 2.5% .level_3 = 4% .level_4 = 6.5% .level_5 = 10% .level_6 = 16% .level_7 = 25% .level_8 = 40% .level_9 = 64% .level_10 = 100%
Description	This configuration property permits to adjust the characteristic of the lamp for the human vision. If DALI lights are used the default values can be kept.

nciHoldTime	
Type	SCPTholdTime (SNVT_time_sec)
Valid Range	0..6553.4 sec Resolution: 0.1 sec
Default Value	600.0 sec
Description	<p>This configuration property defines the hold time for the occupied state. When the OC_OCCUPIED value is received via <i>nviOccup</i> the constant light controller remains in the occupied state until the hold time has expired and then changes to the unoccupied state. If set to 0 the unoccupied state is entered when OC_UNOCCUPIED is received.</p> <p>Note: Setting the <i>nciHoldTime</i> to 0 does not work when using the Echelon LonMaker Browser. As a workaround the LINX Configurator can be used to set the parameters. If used in Plug-In mode parameter values will be synced to the LNS database when downloaded to the L-DALI.</p>

nciPrimeVal	
Type	SNVT_switch
Valid Range	.value: 0..100% .state: 0, 1, -1 On: .state=1 and .value>0 Off: .state=0 and .value=0
Default Value	100%
Description	If the constant light controller operates in PRESENCE or AMBIENT mode, this configuration property defines the value adopted by <i>nvoLampValue</i> when the room is occupied.

nciUnoccupiedLevel	
Type	UCPTunoccupiedLevel (SNVT_lev_cont)
Valid Range	0..100% Resolution: 0.5
Default Value	0.0%
Description	This configuration property defines the value adopted by <i>nvoLampValue</i> when the constant light controller enters unoccupied state (see Section 6.1.4.8).

nciIgnoreTime	
Type	UCPTignoreTime (SNVT_time_sec)
Valid Range	0..6553.4 sec Resolution: 0.1 sec
Default Value	0.0 sec
Description	This configuration property defines the time during which updates on <i>nviOccup</i> are ignored after that lamp was switched off.

nciLuxUpperLimit	
Type	UCPTluxUpperLimit (SNVT_lux)
Valid Range	0..65,335 lux
Default Value	0 lux
Description	The museum mode is activated by setting this configuration property to a value greater than 0. In museum mode the constant light controller cooperates with the sunblind controller to ensure that the measured lux level stays between <i>nciLuxSetpoint</i> and <i>nciLuxUpperLimit</i> . Therefore a sunblind controller has to be linked to the constant light controller by writing the constant light controller index to the configuration property <i>nciCLNumber</i> of the sunblind controller.

nciSblndHyst	
Type	UCPTsunblindHysteresis (SNVT_lev_cont)
Valid Range	0..100% Resolution: 0.5
Default Value	20%
Description	This configuration property applies only for museum mode. It defines by which percentage the lamp dim value is increased before letting more sunlight in by opening the sunblinds.

6.1.5 Sunblind Controller Object #6111

The L-DALI provides 16 sunblind controller objects for each DALI channel.

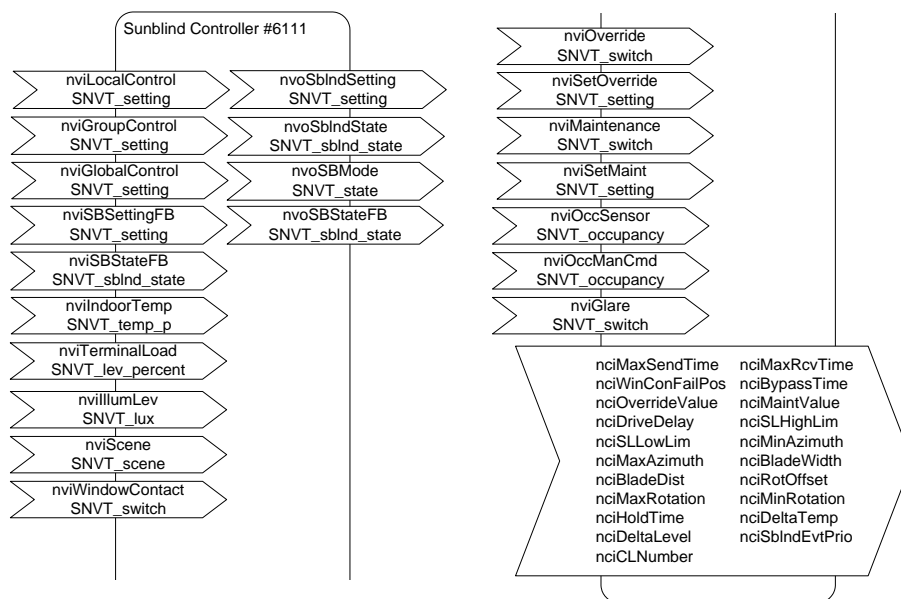

Figure 79: Sunblind Controller Object

This object type is enabled in the default interface. It can be disabled.

6.1.5.1 Glare Protection

The sunblind controller can automatically control the connected sunblind actuator to provide glare protection. To do so the sunblind controller needs to know the geometry of the sunblind blades.

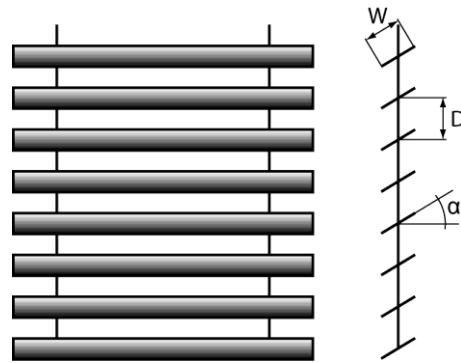

Figure 80: Sunblind Geometry

The blade distance (D) has to be configured in the configuration property *nciBladeDist* and the blade width in *nciBladeWidth*. The minimum and maximum rotation angle (α) is configured in *nciMinRot* and *nciMaxRot*. Based on this geometry data and the current sun elevation (*nviSunElevation*) the glare protection algorithm calculates the rotation angle for the blades. The rotation angle can be optimized for a specific sunblind type by specifying an offset in the configuration property *nciRotOffset*.

The following parameters determine if glare protection is necessary:

- Sun Azimuth (*nviSunAzimuth*): Depending on the orientation of the window, the sun can only shine into the room from a certain azimuth in the morning (*nciMinAzimuth*) to a certain azimuth in the evening (*nciMaxAzimuth*).
- Outdoor lux level (*nviSunLux*): The glare protection will be activated if the measured outdoor lux level is above *nciSiHiLimGlare*. If the outdoor lux level falls below *nciSiLoLimGlare* the glare protection will be deactivated. These two configuration properties implement a hysteresis.
- Surrounding buildings/objects: The network variable inputs *nviGlobalGlare* and *nviGlobalShadow* can be used to provide geometry information on surrounding buildings/objects. Glare protection is active when the corresponding bit in *nviGlobalGlare* is active and the one in *nviGlobalShadow* is inactive.

Alternatively the need for glare protection can be computed by a separate device. In this case the network variable input *nviGlare* can be used to override the automatic glare detection algorithm.

6.1.5.2 View Protection

To protect rooms against prying eyes the sunblind can be closed automatically when the indoor light is switched on and the outdoor light level (*nviSunLux*) falls below the indoor light level (*nviIllumLev*). To avoid that the sunblind opens and closes repeatedly a hysteresis can be configured using the configuration property *nciViewProtHyst*.

6.1.5.3 Heating/Cooling

If the room is not occupied, the L-DALI can close the sunblind to provide thermal isolation in order to save energy.

The network variable input *nviTerminalLoad* is used to inform the controller of the current heating/cooling demand of the system. Positive values indicate that cooling energy is required, while negative values indicate that heating energy is required.

If *nviTerminalLoad* is not bound, but *nviOutdoorTemp* is bound, heating demand is assumed if the moving average outdoor temperature falls below 12°C/54°F, cooling demand is assumed if it is above 19°C/66°F.

The algorithm takes the following parameters into account:

- **Outdoor lux level (*nviSunLux*):** The energy of the sun can be used to warm a room. The configuration property *nciSLHiLimTem* defines the lux level above which the sun energy will make a noticeable contribution to warm the room if the sunblind is open. The configuration property *nciSLLoLimTem* define the lux level below which the sun energy is too low to warm the room. To avoid that the sunblind opens and closes repeatedly a hysteresis can be specified using the configuration property *nciTermSLHyst*.
- **Temperature:** The outdoor temperature (*nviOutdoorTemp*) is compared with the indoor temperature (*nviIndoorTemp*). Depending on whether the system is in heating or in cooling mode and on the temperature difference the sunblinds are closed to increase thermal isolation of the room. To avoid that the sunblind opens and closes repeatedly a hysteresis can be specified using the configuration property *nciTermTempHyst*.

6.1.5.4 Manual Control

To control the sunblind manually the L-DALI sunblind controller offers the possibilities to directly select a setpoint and to select a scene.

Direct Control

The sunblind can be controlled manually by the following network variable inputs of type SNVT_setting:

- ***nviLocalControl*:** Using this input network variable a local control devices can provide the setpoint for the sunblind.
- ***nviGroupControl*:** Using this input network variable a control device which controls a group of sunblinds can provide the setpoint for the sunblind.
- ***nviGlobalControl*:** Using this input network variable a control device which controls all sunblinds can provide the setpoint for the sunblind.

Per default *nviLocalControl* takes precedence over *nviGroupControl* which in turn takes precedence over *nviGlobalControl*. The priorities can be changes as described in Section 6.1.5.9. Local, group, and global control commands can be cancelled by setting the *.function* field of the corresponding network variable to SET_NULL.

Scenes

Using the input network variable *nviSBScene* of type SNVT_scene up to 16 sunblind scenes can be saved and recalled. The command SC_LEARN stores the current sunblind position and rotation in the specified scene number. By a SC_RECALL command previously stored scenes can be recalled. Scenes can be deleted by a SC_RESET command.

6.1.5.5 Prioritized Control

The L-DALI sunblind controller offers two methods for prioritized control: maintenance mode and override mode. Maintenance mode has the highest priority and cannot be changed. The priority of override mode can be changed as described in Section 6.1.5.9.

Maintenance Mode

There are two alternative ways to control the sunblind in maintenance mode:

- ***nviSetMaint***: This input network variable of type *SNVT_setting* overrides the sunblind output. The maintenance mode override is canceled by setting the *.function* field to *SET_NULL*.
- ***nviMaintenance, nciMaintValue***: The *nviMaintenance* network variable of type *SNVT_switch* can be used to switch on/off maintenance mode. If the maintenance mode is active, the sunblind output is set to the value of the configuration property *nciMaintValue* (type *SNVT_setting*).

Override Mode

There are two alternative ways to control the sunblind in override mode:

- ***nviSetOverride***: This input network variable of type *SNVT_setting* overrides the sunblind output. The override is canceled by setting the *.function* field to *SET_NULL*.
- ***nviSBOVERRIDE, nciOverrideValue***: The *nviSBOVERRIDE* network variable of type *SNVT_switch* can be used to switch on/off override mode. If the override mode is active, the sunblind output is set to the value of the configuration property *nciOverrideValue* (type *SNVT_setting*).

6.1.5.6 Museum Mode

For the museum mode of the constant light controller (see Section 6.1.4.12) a sunblind controller must be linked to the constant light controller.

6.1.5.7 Output and Feedback

The L-DALI sunblind controller supports actuators with a control input of type *SNVT_sblnd_state* (see Figure 81) as well as sunblind actuators with a control input of type *SNVT_setting* (see Figure 82).

The configuration property *nciDriveDelay* defines the delay which the sunblind controller waits until it updates its outputs. If different drive delays are configured for the different sunblind controllers, the sunblinds will not drive at the same time avoiding a power peak.

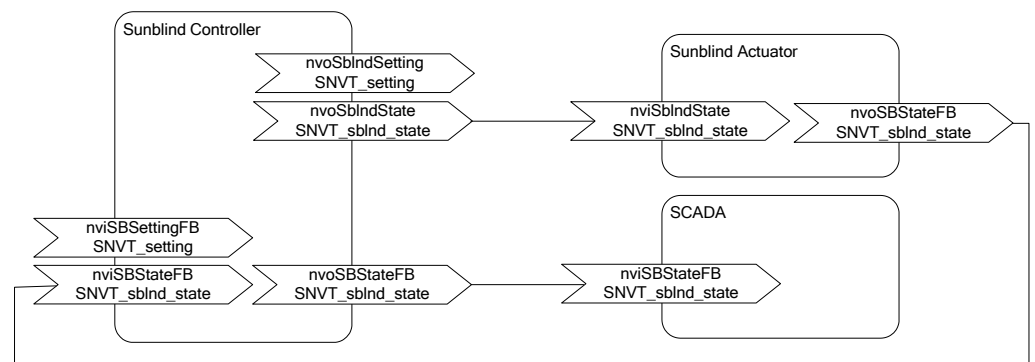

Figure 81: Controlling a Sunblind Actuator via *SNVT_sblnd_state*

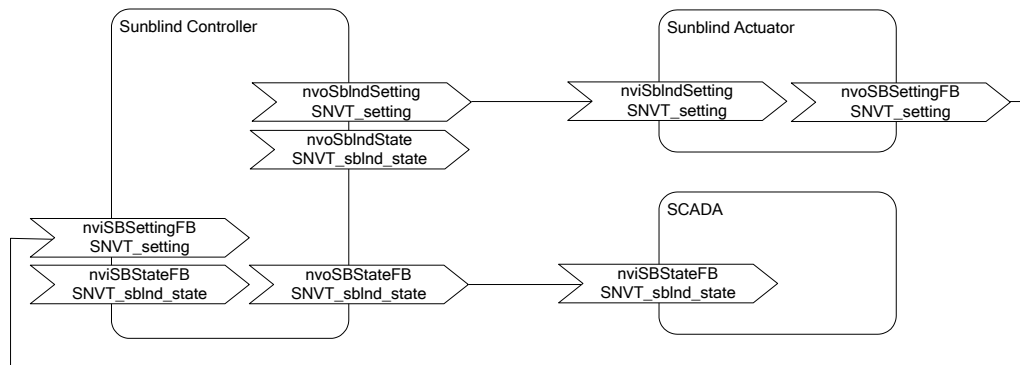

Figure 82: Controlling a Sunblind Actuator via SNVT_setting

The output network variable *nvoSBStateFB* can be used by e.g. a SCADA system to display the current state of the sunblind. It includes status information from the sunblind controller, which is merged with feedback information from the sunblind actuator, if available.

The event state (e.g. maintenance mode, rain condition, wind, etc) of the sunblind controller is reported in the output network variable *nvoSBMode*.

6.1.5.8 Occupancy Detection

The occupied/unoccupied status of the room can be determined by an occupancy sensor and/or a manual command.

Occupancy Sensor

To connect an occupancy sensor the network variable input *nviOccSensor* is used. Its behavior is identical to the *nviOccup* of the Constant Light Controller object (see Section 6.1.4.6).

Manual Command

The network variable input *nviOccManCmd* is used to override the occupancy sensor or if no occupancy sensor is available. This network variable of type *SNVT_occupancy* can have the following values:

- **OC_OCCUPIED:** The sunblind controller should operate in the occupied mode.
- **OC_UNOCCUPIED:** The sunblind controller should operate in the unoccupied mode.
- **OC_BYPASS:** The sunblind controller should operate in the occupied mode for a period of time defined by the configuration property *nciBypassTime*.

6.1.5.9 Sunblind Controller Events and Priority

The operation of the sunblind controller is influenced by a number of events. Table 10 describes the different events and shows their default priority. The priority of events can be changed. Events can be deactivated by setting the priority to -1. Usually this is done on the DALI Parameters tab of the LINX Configurator (see LINX Configurator User Manual [2]).

Priority	Event	Description
18 (highest)	Set maintenance request	The network variable input <i>nviSetMaint</i> is active (.function not SET_NUL). See Section 6.1.5.5 for detail.

Priority	Event	Description
17	Maintenance request	The network variable input <i>nviMaintenance</i> is switched on. The sunblind moves to the position specified in <i>nciMaintValue</i> . See Section 6.1.5.5 for detail.
16	Weather sensor alarm*	At least one of the weather sensors failed: <ul style="list-style-type: none"> No update has been received on <i>nviWind</i> for longer than <i>nciWindRcvT</i>. No update has been received on <i>nviRain</i> for longer than <i>nciRainRcvT</i>. No update has been received on <i>nviFrost</i> for longer than <i>nciFrostRcvT</i>. The alarm condition for the wind, rain, and frost sensor is active only if the corresponding network variable input is bound. In case of a weather sensor alarm the sunblind drives to the position defined by <i>nciWeaSenFailPos</i> .
15	Window sensor alarm*	Window sensor failed: No update has been received on <i>nviWindowContact</i> for longer than <i>nciMaxRcvTime</i> . This alarm is only active if the <i>nviWindowContact</i> network variable is bound. In case of a window sensor alarm the sunblind drives to the position defined by <i>nciWinConFailPos</i> .
14	Frost condition*	The sunblind controller enters the frost state if the network variable input <i>nviFrost</i> is active. When <i>nviFrost</i> becomes inactive the sunblind controller remains in the frost state for the hold time configured in <i>nciRainFroOffDly</i> . The sunblind does not move as long as the sunblind controller is in the frost state.
13	Wind*	The sunblind controller enters the wind alarm state if the measured wind speed (<i>nviWind</i>) exceeds the threshold configured in <i>nciWindLimit</i> . When the wind speed falls below the threshold the sunblind controller remains in the wind alarm state for the hold time configured in <i>nciWindOffDly</i> . The sunblind remains open while the sunblind controller is in the wind alarm state.
12	Rain condition*	The sunblind controller enters the rain state if the network variable input <i>nviRain</i> is active. When <i>nviRain</i> becomes inactive the sunblind controller remains in the rain state for the hold time configured in <i>nciRainFroOffDly</i> . The sunblind remains open while the sunblind controller is in the rain state.
11	Set override request	The network variable input <i>nviSetOverride</i> is active (.function !=SET_NUL). See Section 6.1.5.5 for detail.
10	Override request	The network variable input <i>nviSBOVERRIDE</i> is switched on. The sunblind drives to the position specified in <i>nciOverrideValue</i> . See Section 6.1.5.5 for detail.
9	Window open*	The window is open: The network variable input <i>nviWindowContact</i> is active. The polarity of the window contact can be changed via the configuration property <i>nciInvWinCon</i> . The sunblind does not move as long as the window is open.
8	Local control	The network variable input <i>nviLocalControl</i> is active. See Section 6.1.5.4 for detail.
7	Group control	The network variable input <i>nviGroupControl</i> is active. See Section 6.1.5.4 for detail.
6	Global control	The network variable input <i>nviGlobalControl</i> is active. See Section 6.1.5.4 for detail.
5	Scene selection	Sunblind scene recalled via network variable input <i>nviScene</i> . See Section 6.1.5.4 for detail.

Priority	Event	Description
4	Anti-glare*	The sunblind is controlled by the anti-glare algorithm. Only active if room is occupied. See Section 6.1.5.1 for detail.
3	View protection*	The sunblind is controlled by the view protection algorithm. Only active if room is occupied. See Section 6.1.5.2 for detail.
2	Constant light request*	The sunblind is linked to the constant light controller and is controlled by the museum mode algorithm. Only active if room is occupied. See Section 6.1.4.12 for detail.
1	Up if occupied*	The room is occupied. See Section 6.1.5.8 for detail. If the room is occupied the sunblind moves up.
0 (lowest)	Heat/cool request*	The sunblind is controlled by the heating/cooling algorithm. Only active if room is not occupied. See Section 6.1.5.3 for detail.

Table 10: Sunblind Controller Events and Priority

For events marked with *) a minimum time can be configured via the configuration property *nciAutoEvMinTm*. These events will stay active for at least the configured time even if the event condition disappears before this time expires. In this way the sunblind controller ensures that the sunblind does not drive too frequently.

In case none of the events is active the sunblind remains in its current position.

6.1.5.10 Input Network Variables

nviLocalControl	
Type	SNVT_setting
Valid Range	.function: SET_NUL (-1): Invalid value. SET_DOWN (2) Decrease setting by specified value. SET_UP (3) Increase setting by specified value. SET_STOP (4) Stop action. SET_STATE (5) Setting on at specified value. .setting: 0..100, resolution 0.5 .rotation: -359.98 .. 360.00, resolution 0.02
Default Value	-
Description	This network variable input is used to manually control the sunblind. Usually a local control device gives this command. A local control command can be canceled by setting .function to SET_NUL.

nviGroupControl	
Type	SNVT_setting
Valid Range	.function: SET_NUL (-1): Invalid value SET_DOWN (2) Decrease setting by specified value SET_UP (3) Increase setting by specified value SET_STOP (4) Stop action SET_STATE (5) Setting on at specified value .setting: 0..100, resolution 0.5 .rotation: -359.98 .. 360.00, resolution 0.02
Default Value	-
Description	This network variable input is used to manually control the sunblind. Usually a device which is intended to control groups of controllers or actuators gives this command A group control command can be canceled by setting .function to SET_NUL.

nviGlobalControl	
Type	SNVT_setting
Valid Range	.function: SET_NUL (-1): Invalid value SET_DOWN (2) Decrease setting by specified value SET_UP (3) Increase setting by specified value SET_STOP (4) Stop action SET_STATE (5) Setting on at specified value .setting: 0..100, resolution 0.5 .rotation: -359.98 .. 360.00, resolution 0.02
Default Value	-
Description	This network variable input is used to manually control the sunblind. Usually a device which is intended to control all controllers or actuators gives this command A global control command can be canceled by setting .function to SET_NUL.

nviSBSettingFB	
Type	SNVT_setting
Valid Range	.function: SET_NUL (-1): Invalid value. SET_DOWN (2) Decrease setting by specified value. SET_UP (3) Increase setting by specified value. SET_STOP (4) Stop action. SET_STATE (5) Setting on at specified value. .setting: 0..100, resolution 0.5 .rotation: -359.98 .. 360.00, resolution 0.02
Default Value	-
Description	Feedback from sunblind actuator of type <i>SNVT_setting</i> .

nviSBStateFB	
Type	SNVT_sbldn_state
Valid Range	.pos.function: SET_NUL (-1): Invalid value. SET_DOWN (2) Decrease setting by specified value. SET_UP (3) Increase setting by specified value. SET_STOP (4) Stop action. SET_STATE (5) Setting on at specified value. .pos.setting: 0..100, resolution 0.5 .pos.rotation: -359.98 .. 360.00, resolution 0.02 .cmd_source: SBCS_NUL, SBCS_LOCAL, SBCS_GROUP,error_code: SBE_NUL, SBE_NO_ERROR, SBE_IN_PROGRESS, ...
Default Value	-
Description	Feedback from sunblind actuator of type <i>SNVT_sbldn_state</i> .

nviIndoorTemp	
Type	SNVT_temp_p
Valid Range	-273.17°C...327.66°C Resolution: 0.01°C
Default Value	-
Description	This network variable input provides the room temperature measured by a temperature sensor. This input is used if the sunblinds are used for heating/cooling (see Section 6.1.5.3).

nviTerminalLoad	
Type	SNVT_lev_percent
Valid Range	-163.840..163.830 Resolution: 0.005
Default Value	
Description	This network variable input is used if the sunblinds are used for heating/cooling (see Section 6.1.5.3). The input informs the controller of the current heating/cooling demand. Positive values indicate that cooling energy is required, while negative values indicate that heating energy is required. If the network variable is not bound, the heating/cooling feature is disabled.

nviIllumLev	
Type	SNVT_lux
Valid Range	0..65,335 lux
Default Value	-
Description	This network variable input provides the illumination level in the room. The input is used for view protection (see Section 6.1.5.2). If <i>nviIllumLev</i> is higher than the <i>nviSunLux</i> then the sunblind is closed to protect the room against prying eyes.

nviScene									
Type	SNVT_scene								
Valid Range	0..65,335 lux								
Default Value	.function: SC_LEARN, SC_RECALL, SC_NUL .scene_number: 1..16								
Description	Using this input network variable up to 16 sunblind scenes can be saved and recalled. <table border="1" data-bbox="352 1608 1310 1807"> <thead> <tr> <th>Function</th> <th>Description</th> </tr> </thead> <tbody> <tr> <td>SC_LEARN</td> <td>Stores the current sunblind position and rotation in the specified scene number.</td> </tr> <tr> <td>SC_RECALL</td> <td>Recall a previously stored scene.</td> </tr> <tr> <td>SC_RESET</td> <td>Delete a scene.</td> </tr> </tbody> </table>	Function	Description	SC_LEARN	Stores the current sunblind position and rotation in the specified scene number.	SC_RECALL	Recall a previously stored scene.	SC_RESET	Delete a scene.
Function	Description								
SC_LEARN	Stores the current sunblind position and rotation in the specified scene number.								
SC_RECALL	Recall a previously stored scene.								
SC_RESET	Delete a scene.								

nviWindowContact	
Type	SNVT_switch
Valid Range	.value: 0..100% .state: 0, 1 Open: .state=1 and .value=100 Closed: .state=0 and .value=0
Default Value	-
Description	This network variable input informs the controller if the window is open or close. If the window is open, the sunblind stops moving.

nviOverride	
Type	SNVT_switch
Valid Range	.value: 0..100% .state: 0, 1 On: .state=1 and .value>=0.5% Off: .state=0 and .value=0
Default Value	-
Description	This network variable input is used to switch on/off override mode. If override mode is activated (.state=1 and .value between 0.5% and 100%), the sunblind adopts the setting specified by <i>nciOverrideValue</i> .

nviSetOverride	
Type	SNVT_setting
Valid Range	.function: SET_NULL (-1): Invalid Value SET_DOWN (2) Decrease setting by specified value SET_UP (3) Increase setting by specified value SET_STOP (4) Stop action SET_STATE (5) Setting on at specified value .setting: 0..100, resolution 0.5 .rotation: -359.98 .. 360.00, resolution 0.02
Default Value	-
Description	This input network variable overrides the sunblind output. The override is canceled by setting the .function field to SET_NULL.

nviMaintenance	
Type	SNVT_switch
Valid Range	.value: 0..100% .state: 0, 1 On: .state=1 and .value>=0.5% Off: .state=0 and .value=0
Default Value	-
Description	This network variable input is used to switch on/off maintenance mode. If maintenance mode is activated (.state=1 and .value between 0.5% and 100%), the sunblind adopts the setting specified by <i>nciMaintValue</i> .

nviSetMaint	
Type	SNVT_setting
Valid Range	.function: SET_NUL (-1): Invalid Value SET_DOWN (2) Decrease setting by specified value SET_UP (3) Increase setting by specified value SET_STOP (4) Stop action SET_STATE (5) Setting on at specified value .setting: 0..100, resolution 0.5 .rotation: -359.98 .. 360.00, resolution 0.02
Default Value	-
Description	This input network variable overrides the sunblind output. The override is canceled by setting the .function field to SET_NULL.

nviOccupSensor	
Type	SNVT_occupancy
Valid Range	OC_NUL (-1): Invalid Value OC_OCCUPIED (0): Area is occupied OC_UNOCCUPIED (1): Area is unoccupied OC_BYPASS (2): Ignored OC_STANDBY (3): Ignored
Default Value	-
Description	This network variable input provides the occupancy state measured by an occupancy sensor. A hold time can be configured using the configuration property <i>nciHoldTime</i> .

nviOccManCmd											
Type	SNVT_occupancy										
Valid Range	OC_NUL (-1): Invalid Value OC_OCCUPIED (0): Area is occupied OC_UNOCCUPIED (1): Area is unoccupied OC_BYPASS (2): Area is temporarily occupied for the bypass period OC_STANDBY (3): Ignored										
Default Value	-										
Description	This network variable input can be used to manually control the occupancy state. <table border="1" data-bbox="352 1480 1326 1780"> <thead> <tr> <th>Value</th> <th>Description</th> </tr> </thead> <tbody> <tr> <td>OC_NUL</td> <td>This is the initial value after power-up and it remains until another value is received. It is used to indicate that this network variable input is invalid, unused or to cancel a previous command.</td> </tr> <tr> <td>OC_OCCUPIED</td> <td>The sunblind controller should operate in the occupied mode.</td> </tr> <tr> <td>OC_UNOCCUPIED</td> <td>The sunblind controller should operate in the unoccupied mode</td> </tr> <tr> <td>OC_BYPASS</td> <td>The sunblind controller should operate in the occupied mode for a period of time defined by <i>nciBypassTime</i>.</td> </tr> </tbody> </table>	Value	Description	OC_NUL	This is the initial value after power-up and it remains until another value is received. It is used to indicate that this network variable input is invalid, unused or to cancel a previous command.	OC_OCCUPIED	The sunblind controller should operate in the occupied mode.	OC_UNOCCUPIED	The sunblind controller should operate in the unoccupied mode	OC_BYPASS	The sunblind controller should operate in the occupied mode for a period of time defined by <i>nciBypassTime</i> .
Value	Description										
OC_NUL	This is the initial value after power-up and it remains until another value is received. It is used to indicate that this network variable input is invalid, unused or to cancel a previous command.										
OC_OCCUPIED	The sunblind controller should operate in the occupied mode.										
OC_UNOCCUPIED	The sunblind controller should operate in the unoccupied mode										
OC_BYPASS	The sunblind controller should operate in the occupied mode for a period of time defined by <i>nciBypassTime</i> .										

nviGlare									
Type	SNVT_switch								
Valid Range	.value: 0..100% .state: 0, 1,-1 On: .state=1 and .value>=0.5% Off: .state=0 and .value=0 Auto .state=-1								
Default Value	-								
Description	This network variable is used to override the automatic glare detection algorithm (see Section 6.1.5.1). <table border="1" data-bbox="507 595 1481 772"> <thead> <tr> <th>Value</th> <th>Description</th> </tr> </thead> <tbody> <tr> <td>On</td> <td>Glare condition.</td> </tr> <tr> <td>Off</td> <td>No glare condition.</td> </tr> <tr> <td>Auto</td> <td>Use automatic glare detection algorithm.</td> </tr> </tbody> </table>	Value	Description	On	Glare condition.	Off	No glare condition.	Auto	Use automatic glare detection algorithm.
Value	Description								
On	Glare condition.								
Off	No glare condition.								
Auto	Use automatic glare detection algorithm.								

6.1.5.11 Output Network Variables

nvoSblndSetting	
Type	SNVT_setting
Valid Range	.function: SET_NUL (-1): Invalid Value SET_DOWN (2) Decrease setting by specified value SET_UP (3) Increase setting by specified value SET_STOP (4) Stop action SET_STATE (5) Setting on at specified value .setting: 0..100, resolution 0.5 .rotation: -359.98 .. 360.00, resolution 0.02
Default Value	-
Description	This network variable output provides the setpoint for the sunblind actuator.

nvoSblndState	
Type	SNVT_sblnd_state
Valid Range	.pos.function: SET_NUL (-1): Invalid Value SET_DOWN (2) Decrease setting by specified value SET_UP (3) Increase setting by specified value SET_STOP (4) Stop action SET_STATE (5) Setting on at specified value .pos.setting: 0..100, resolution 0.5 .pos.rotation: -359.98 .. 360.00, resolution 0.02 .cmd_source: SBSC_NUL, SBSC_LOCAL, SBSC_GROUP,error_code: SBE_NUL, SBE_NO_ERROR, SBE_IN_PROGRESS, ...
Default Value	-
Description	This network variable output provides the setpoint for the sunblind actuator and reports errors and the cause of the latest change (as determined by the sunblind controller).

nvoSBMode	
Type	SNVT_state_64
Valid Range	.bit0: Heat/cool request .bit1: Up if occupied .bit2: Constant light request .bit3: View protection .bit4: Anti-glare .bit5: Scene selection .bit6: Global control .bit7: Group control .bit8: Local control .bit9: Window open .bit10: Override request .bit11: Set override request .bit12: Rain condition .bit13: Wind .bit14: Frost condition .bit15: Window sensor alarm .bit16: Weather sensor alarm .bit17: Maintenance request .bit18: Set maintenance request .bit19: Not usedbit64: Not used
Default Value	-
Description	This network variable output reports the active events of the sunblind controller (see Section 6.1.5.9).

nvoSBStateFB	
Type	SNVT_sblnd_state
Valid Range	.pos.function: SET_NUL (-1): Invalid Value SET_OFF (0): Setting off SET_ON (1) Setting on SET_DOWN (2) Decrease setting by specified value SET_UP (3) Increase setting by specified value SET_STOP (4) Stop action SET_STATE (5) Setting on at specified value .pos.setting: 0..100, resolution 0.5 .pos.rotation: -359.98 .. 360.00, resolution 0.02 .cmd_source: SBCS_NUL, SBCS_LOCAL, SBCS_GROUP,error_code: SBE_NUL, SBE_NO_ERROR, SBE_IN_PROGRESS, ...
Default Value	-
Description	This network variable output provides a feedback to a SCADA system: <ul style="list-style-type: none"> • If the sunblind actuator provides a feedback variable of type <i>SNVT_sblnd_state</i> and it is bound to <i>nviSBStateFB</i> the sunblind actuator feedback value is copied to <i>nvoSBStateFB</i>. • If this is not the case, but the sunblind actuator provides a feedback variable of type <i>SNVT_setting</i> and it is bound to <i>nviSBSettingFB</i> the value is copied to <i>nvoSBStateFB</i> with the <i>cmd_source</i> field copied from the <i>nvoSblndState</i>. • If none of the above is the case, the value of <i>nvoSblndState</i> is copied to <i>nvoSBStateFB</i>.

6.1.5.12 Configuration Properties

All configuration properties listed in this section are implemented as Configuration Parameters using configuration files (CPT, CPV, and CPC files). File access is provided via LONMARK FTP.

nciLocation	
Type	SCPTLocation (SNVT_str_asc)
Valid Range	31 ASCII characters
Default Value	Sunblind Ctrl X
Description	This configuration property can be used to specify the name of the sunblind controller.

nciMaxSendTime	
Type	SCPTmaxSendTime (SNVT_time_sec)
Valid Range	0..6553.4 sec Resolution: 0.1 sec
Default Value	0 sec
Description	Maximum time between updates for the <i>nvoSblindSetting</i> and <i>nvoSblindState</i> outputs (heartbeat functionality).

nciMaxRcvTime	
Type	SCPTmaxRcvTime (SNVT_time_sec)
Valid Range	0..6553.4 sec Resolution: 0.1 sec
Default Value	0.0 sec (disabled)
Description	This configuration property specifies the expected update interval of the <i>nviWindowContact</i> network variable input. If the time elapses without an update of the variable an alarm is generated and the sunblind adopts the safe position defined by the <i>nciWinConFailPos</i> .

nciWinConFailPos	
Type	SCPTdefaultSetting (SNVT_setting)
Valid Range	.function: SET_NUL (-1): Invalid Value SET_DOWN (2) Decrease setting by specified value SET_UP (3) Increase setting by specified value SET_STOP (4) Stop action SET_STATE (5) Setting on at specified value .setting: 0..100, resolution 0.5 .rotation: -359.98 .. 360.00, resolution 0.02
Default Value	SET_STATE, 0%, 0 deg
Description	This configuration property defines the safety position of a sunblind when a failure of the window contact (<i>nviWindowContact</i>) has been detected.

nciBypassTime	
Type	SCPTbypassTime (SNVT_time_min)
Valid Range	0..65,535 minutes
Default Value	0
Description	This configuration property defines the amount of time that the sunblind controller is in bypass (occupancy) mode following a single bypass request via <i>nviOccManCmd</i> . Additional bypass requests can restart the timer. Setting this configuration property to zero disables the bypass function and no bypass takes place.

nciOverrideValue	
Type	SCPTdefaultSetting (SNVT_setting)
Valid Range	.function: SET_NUL (-1): Invalid Value SET_DOWN (2) Decrease setting by specified value SET_UP (3) Increase setting by specified value SET_STOP (4) Stop action SET_STATE (5) Setting on at specified value .setting: 0..100, resolution 0.5 .rotation: -359.98 .. 360.00, resolution 0.02
Default Value	SET_NUL
Description	This configuration property defines the override value which is adopted by the sunblind when the <i>nviOverride</i> is at ON.

nciMaintValue	
Type	SCPTdefaultSetting (SNVT_setting)
Valid Range	.function: SET_NUL (-1): Invalid Value SET_DOWN (2) Decrease setting by specified value SET_UP (3) Increase setting by specified value SET_STOP (4) Stop action SET_STATE (5) Setting on at specified value .setting: 0..100, resolution 0.5 .rotation: -359.98 .. 360.00, resolution 0.02
Default Value	SET_NUL
Description	This configuration property defines the maintenance value which is adopted by the sunblind when the <i>nviMaintenance</i> is at ON.

nciDriveDelay	
Type	UCPTdriveDelay (SNVT_time_sec)
Valid Range	0..6553.4 sec Resolution: 0.1 sec
Default Value	0.0 sec (no delay)
Description	This configuration property defines the delay which the sunblind controller waits before it updates its outputs. If different drive delays are configured for the different sunblind controllers, the sunblinds will not drive at the same time avoiding a power peak. No drive delay is applied for local control (<i>nviLocalControl</i>).

nciSiHiLimGlare	
Type	UCPTsunLuxHighLimit (SNVT_lux)
Valid Range	0..65,335 lux
Default Value	30000
Description	This configuration property defines the high limit for the sun lux level input used by the automatic glare detection algorithm (see Section 6.1.5.1)

nciSiLoLimGlare	
Type	UCPTsunLuxHighLimit (SNVT_lux)
Valid Range	0..65,335 lux
Default Value	10000
Description	This configuration property defines the low limit for the sun lux level input used by the automatic glare detection algorithm (see Section 6.1.5.1)

nciMinAzimuth	
Type	UCPTminAzimuth (SNVT_angle_deg)
Valid Range	-359.98..360.00 deg Resolution: 0.02 deg
Default Value	0
Description	This configuration property defines the minimum azimuth for the sun elevation input used by the automatic glare detection algorithm (see Section 6.1.5.1).

nciMaxAzimuth	
Type	UCPTmaxAzimuth (SNVT_angle_deg)
Valid Range	-359.98..360.00 deg Resolution: 0.02 deg
Default Value	0
Description	This configuration property defines the maximum azimuth for the sun elevation input used by the automatic anti-glare algorithm (see Section 6.1.5.1).

nciBladeDist	
Type	UCPTbladeDistance (SNVT_length_mil)
Valid Range	0 ... 6533.5 mm Resolution: 0.1 mm
Default Value	7 cm
Description	This configuration property defines the distance between sunblind blades (see Section 6.1.5.1).

nciBladeWidth	
Type	UCPTbladeWidth (SNVT_length_mil)
Valid Range	0 ... 6533.5 mm Resolution: 0.1 mm
Default Value	9 cm
Description	This configuration property defines the width of the sunblind blades (see Section 6.1.5.1).

nciRotOffset	
Type	UCPTrotationOffset (SNVT_angle_deg)
Valid Range	-359.98..360.00 deg Resolution: 0.02 deg
Default Value	0
Description	This configuration property defines the rotation offset for the glare protection algorithm (see Section 6.1.5.1).

nciMaxRot	
Type	UCPTmaxRotation (SNVT_angle_deg)
Valid Range	-359.98..360.00 deg Resolution: 0.02 deg
Default Value	90
Description	This configuration property defines the maximum rotation for the glare protection algorithm (see Section 6.1.5.1).

nciMinRot	
Type	UCPTminRotation (SNVT_angle_deg)
Valid Range	-359.98..360.00 deg Resolution: 0.02 deg
Default Value	0
Description	This configuration property defines the minimum rotation for the glare protection algorithm (see Section 6.1.5.1).

nciDeltaTemp	
Type	SCPTminDeltaTemp (SNVT_temp_p)
Valid Range	-273.17°C...327.66°C Resolution: 0.01°C
Default Value	1°C
Description	This configuration property defines the amount by which the indoor temperature (<i>nviIndoorTemp</i>) value must change before it can take in account.

nciHoldTime	
Type	SCPTholdTime (SNVT_time_sec)
Valid Range	0..6553.4 sec Resolution: 0.1 sec
Default Value	600 sec
Description	This configuration property defines the hold time for the occupied state. When the OC_OCCUPIED value is received via <i>nviOccupSensor</i> the sunblind controller remains in the occupied state until the hold time has expired and then changes to the unoccupied state. If set to 0 the unoccupied state is entered when OC_UNOCCUPIED is received (see Section 6.1.5.8).

nciSblndEvtPrio	
Type	UCPTsunblindEventPriority
Valid Range	.heat_cool_req: -128..127 .up_if_occupied: -128..127 .constant_light_req: -128..127 .view_protect: -128..127 .glare: -128..127 .scene_sel: -128..127 .global_req: -128..127 .group_req: -128..127 .local_req: -128..127 .window: -128..127 .override_req: -128..127 .set_override_req: -128..127 .rain: -128..127 .wind: -128..127 .frost: -128..127 .window_sensor_alarm: -128..127 .weather_sensor_alarm: -128..127 .maintenance_req: -128..127 .set_maintenance_req: -128..127
Default Value	All 0
Description	This configuration property defines the priorities of sunblind events (see Section 6.1.5.9). Higher values render higher priority. If multiple events have the same priority then they are prioritized with the default priority. Events can be disabled by setting a negative value for its priority. Events <i>maintenance_req</i> and <i>set_maintenance_req</i> will always be the highest priority events. Their value is used to define which of the two events has the higher priority.

nciAutoEvMinTm	
Type	UCPTautoDelay (SNVT_time_sec)
Valid Range	0..6553.4 sec Resolution: 0.1 sec
Default Value	600 sec
Description	<p>Use to specify the minimum time for the following events:</p> <ul style="list-style-type: none"> • Weather sensor alarm • Window sensor alarm • Frost condition • Wind • Rain condition • Window open • Anti-glare • View protection • Constant light request • Up if occupied • Heating/cooling request <p>The event will stay active for at least the configured time even if the event condition disappears before this time expires. In this way the sun blind controller ensures that the sunblind does not drive too frequently.</p>

nciCLNumber	
Type	UCPTobjectIndex (SNVT_count)
Valid Range	0..15 0xFFFF invalid
Default Value	0xFFFF (no Constant Light Controller linked)
Description	<p>This configuration property specifies the index of the constant light controller that is linked to the sunblind controller (see Section 6.1.4.7 und 6.1.4.12).</p> <p>Object indices start with index 0.</p>

6.1.6 Globals #0005

The L-DALI provides one Globals object for each DALI channel. It provides global network variable inputs and configuration properties which are not specific for a certain constant light controller or sunblind controller.

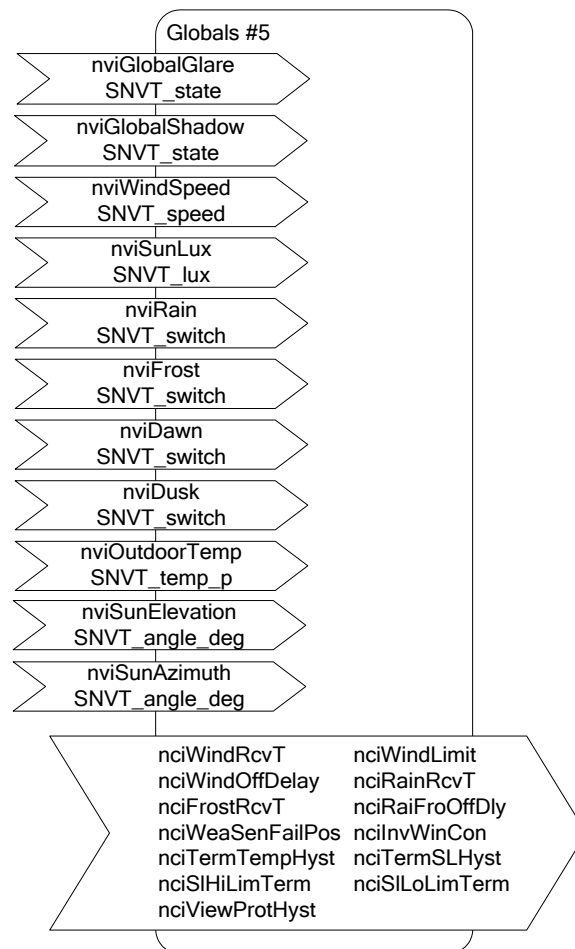

Figure 83: Global Object

This object type is enabled in the default interface. It will be disabled with the Sunblind Controller objects.

6.1.6.1 Network Variable Inputs

nviGlobalGlare	
Type	SNVT_state
Valid Range	.bit0 0, 1bit15 0, 1
Default Value	
Description	This network input permits an external calculation of glare condition for all of the 16 sunblind controllers per channel (see Section 6.1.5.1). Automatic glare protection for the sunblind controller object x is deactivated if the bit with index x is not set.

nviGlobalShadow	
Type	SNVT_state
Valid Range	.bit0 0, 1bit15 0, 1
Default Value	
Description	This network input permits an external calculation of shadow condition for all of the 16 sunblind controllers per channel (see Section 6.1.5.1). Automatic glare protection for the sunblind controller object x is deactivated if the bit with index x is set.

nviWindSpeed	
Type	SNVT_speed
Valid Range	0..6553.5 m/s Resolution: 0.1 m/s
Default Value	
Description	This network variable input provides the current wind speed measured by a wind sensor. If the wind speed is higher than the value configured in <i>nciWindLimit</i> , the sunblinds must go up.

nviSunLux	
Type	SNVT_lux
Valid Range	0..65,335 lux
Default Value	
Description	This network variable input provides the current outdoor illumination measured by a light sensor.

nviRain	
Type	SNVT_switch
Valid Range	.value: 0..100% .state: 0, 1 Rain: .state=1 and .value>=0.5% No Rain: .state=0 and .value=0
Default Value	
Description	This network variable input provides the rain status. If it is raining, the sunblinds must go up.

nviFrost	
Type	SNVT_switch
Valid Range	.value: 0..100% .state: 0, 1 Frost: .state=1 and .value>=0.5% No Frost: .state=0 and .value=0
Default Value	
Description	This network variable input provides the frost status. If a frost condition is detected, the sunblinds must not move.

nviDawn	
Type	SNVT_switch
Valid Range	.value: 0..100% .state: 0, 1 Dawn: .state=1 and .value>=0.5% No Dawn: .state=0 and .value=0
Default Value	
Description	Currently not used.

nviDusk	
Type	SNVT_switch
Valid Range	.value: 0..100% .state: 0, 1 Dusk: .state=1 and .value>=0.5% No Dusk: .state=0 and .value=0
Default Value	
Description	Currently not used.

nviOutdoorTemp	
Type	SNVT_temp_p
Valid Range	-273.17°C..327.66°C Resolution: 0.01°C
Default Value	
Description	This network variable input provides the current outdoor temperature. This input is used when the sunblinds are used to heat/cool a room (see Section 6.1.5.3).

nviSunElevation	
Type	SNVT_angle_deg
Valid Range	-359.98..360.00 deg Resolution: 0.02 deg
Default Value	
Description	This network variable input provides the current sun elevation. The elevation is the angle between the horizon and the middle of the sun, considered out of the viewpoint of an observer. The values 0 – 90° are typically used (0= Sunrise/Sunset; 90 = zenith position).

nviSunAzimuth	
Type	SNVT_angle_deg
Valid Range	-359.98..360.00 deg Resolution: 0.02 deg
Default Value	
Description	This network variable input provides the current sun azimuth. The values 0 – 359° are typically used (0 = NORTH, 90 = EAST, 180 = SOUTH, 270 = WEST).

6.1.6.2 Configuration Properties

All configuration properties listed in this section are implemented as Configuration Parameters using configuration files (CPT, CPV, and CPC files). File access is provided via LONMARK FTP.

nciWindRcvT	
Type	SCPTmaxRcvTime (SNVT_time_sec)
Valid Range	0..6553.4 sec Resolution: 0.1 sec
Default Value	0.0 sec (disabled)
Description	This configuration property specifies the expected update interval of the <i>nviWindspeed</i> network variable input. If the time elapses without an update of the variable an alarm is generated and the sunblinds adopt the safe position defined by <i>nciWeaSenFailPos</i> .

nciWindLimit	
Type	UCPTwindLimit (SNVT_time_sec)
Valid Range	0..6553.4 sec Resolution: 0.1 sec
Default Value	0.0 sec
Description	This configuration property defines the maximum wind for the sunblinds. If the current wind speed (<i>nviWindspeed</i>) is greater than the configured values the sunblinds must go up.

nciWindOffDelay	
Type	UCPTweaSenOffDelay (SNVT_time_sec)
Valid Range	0..6553.4 sec Resolution: 0.1 sec
Default Value	0.0 sec
Description	This configuration property defines the time for which the current wind speed (<i>nviWindspeed</i>) must be below the critical wind speed (<i>nciWindLimit</i>) before the sunblind controller return to normal operation.

nciRainRcvT	
Type	SCPTmaxRcvTime (SNVT_time_sec)
Valid Range	0..6553.4 sec Resolution: 0.1 sec
Default Value	0.0 sec (disabled)
Description	This configuration property specifies the expected update interval of the <i>nviRain</i> network variable input. If the time elapses without an update of the variable an alarm is generated and the sunblinds adopt the safe position defined by <i>nciWeaSenFailPos</i> .

nciFrostRcvT	
Type	SCPTmaxRcvTime (SNVT_time_sec)
Valid Range	0..6553.4 sec Resolution: 0.1 sec
Default Value	0.0 sec (disabled)
Description	This configuration property specifies the expected update interval of the <i>nviFrost</i> network variable input. If the time elapses without an update of the variable an alarm is generated and the sunblinds adopt the safe position defined by <i>nciWeaSenFailPos</i> .

nciRaiFroOffDly	
Type	UCPTweaSenOffDelay (SNVT_time_sec)
Valid Range	0..6553.4 sec Resolution: 0.1 sec
Default Value	0.0 sec
Description	This configuration property defines the time for which the rain/frost condition (<i>nviRain/nviFrost</i>) has to be inactive before the sunblind controller returns to normal operation.

nciWeaSenFailPos	
Type	SCPTdefaultSetting (SNVT_setting)
Valid Range	.function: SET_NUL (-1): Invalid Value SET_DOWN (2) Decrease setting by specified value SET_UP (3) Increase setting by specified value SET_STOP (4) Stop action SET_STATE (5) Setting on at specified value .setting: 0..100, resolution 0.5 .rotation: -359.98 .. 360.00, resolution 0.02
Default Value	SET_STATE, 0%, 0 deg
Description	This configuration property defines the safety position of sunblinds when a failure of a safety relevant weather sensor (e.g. <i>nviWindspeed</i> , <i>nviRain</i> or <i>nviFrost</i>) is detected.

nciInvWinCon	
Type	UCPTautoOffBreak (SNVT_lev_disc)
Valid Range	ST_ON, ST_OFF Inverted: ST_ON Not Inverted: ST_OFF
Default Value	ST_OFF (not inverted)
Description	This configuration property allows inverting the window contact inputs of the sunblind controllers (<i>nviWindowContact</i>).

nciTermTempHyst	
Type	SCPTtemperatureHysteresis (SNVT_temp_diff_p)
Valid Range	-327.68°C..327.66°C Resolution: 0.01°C
Default Value	1°C
Description	This configuration property defines the hysteresis for the outdoor temperature (<i>nviOutdoorTemp</i>). It is used for the heating/cooling algorithm (see Section 6.1.5.3).

nciTermSLHyst	
Type	UCPTterminalLoadSLhysteresis (SNVT_lev_cont)
Valid Range	0..100% Resolution: 0.5
Default Value	5.0%
Description	This configuration property defines the hysteresis for the sun lux level input (<i>nviSunLux</i>). It is used by the heating/cooling algorithm (see Section 6.1.5.3).

nciSIHighLimTerm	
Type	UCPTsunLuxHighLimit (SNVT_lux)
Valid Range	0..65,335 lux
Default Value	30000
Description	This configuration property defines the high limit for the sun lux level input (<i>nviSunLux</i>). It is used by the heating/cooling algorithm (see Section 6.1.5.3).

nciSILowLimTerm	
Type	UCPTsunLuxLowLimit (SNVT_lux)
Valid Range	0..65,335 lux
Default Value	10000 lux
Description	This configuration property defines the low limit for the sun lux level input (<i>nviSunLux</i>). It is used by the heating/cooling algorithm (see Section 6.1.5.3).

nciViewProtHyst	
Type	UCPTviewProtectionSLhysteresis (SNVT_lev_cont)
Valid Range	0..100% Resolution: 0.5
Default Value	5.0%
Description	This configuration property defines the hysteresis for the sun lux level input (<i>nviSunLux</i>). It is used by the view protection algorithm (see Section 6.1.5.2).

6.1.7 Button #0001

The L-DALI provides 64 button objects for each DALI channel to represent DALI buttons, switches, remote controls, panels etc. supported by the L-DALI. See the DALI Section in the LOYTEC Device User Manual [1] for supported devices.

This object type is disabled in the default interface. If required these objects must be enabled as described in the project settings (see LINX Configurator User Manual [2]). The network variables available in the button objects depend on the template selected in the project settings.

In any case the object contains the following configuration properties:

nciLocation	
Type	SCPTLocation (SNVT_str_asc)
Valid Range	31 ASCII characters
Default Value	Button X
Description	This configuration property can be used to specify the name of the button.

The following object templates are available:

6.1.7.1 SNVT_switch

This template has to be selected when a DALI button device allowing button function configuration is used and the state of the button has to be available on the LONMARK interface. In this case each Button object contains the following network variables:

nvoButtonState	
Type	SNVT_state
Valid Range	-
Default Value	0
Description	If a button input is configured with the button function <i>Network data point</i> the state of this input is mapped to the corresponding bit of the <i>SNVT_state</i> (bit0 to input 1, bit1 to input 2, etc.). The bit is set to 1 if the button is pressed or the contact is closed and 0 otherwise.

6.1.7.2 Philips OccuSwitch

This template has to be selected when expanding an IRT 8080 IR-remote control the Philips OccuSwitch DALI LRM2090/20 to controlling sunblinds, fan speed, and temperature setpoint in a room. In this case each Button object contains the following network variables:

nvoSetPtOffset	
Type	SNVT_temp_p
Valid Range	-3°C to +3°C
Default Value	-
Description	This network variable output allows adjusting the HVAC setpoint by supplying an offset to a preconfigured setpoint. Its value is controlled by the temperature setpoint button on the IRT 8080.

nvoFanSpeedCmd	
Type	SNVT_switch
Valid Range	.value: 0%, 33%, 66%, 100% .state: 0, 1 On: .state = 1 and .value > 0 Off: .state = 0 and .value=any or .state=1 and .value = 0
Default Value	-
Description	This network variable output allows control the speed of a ventilation fan. Its value is controlled by the temperature fan speed button on the IRT 8080.

nvoSblndControl	
Type	SNVT_setting
Valid Range	.function: SET_NUL (-1): Invalid value. SET_DOWN (2) Decrease setting by specified value. SET_UP (3) Increase setting by specified value. SET_STOP (4) Stop action. SET_STATE (5) Setting on at specified value. .setting: 0..100, resolution 0.5 .rotation: -359.98 .. 360.00, resolution 0.02
Default Value	-
Description	This network variable output allows control the position and the rotation of a sunblind (via a sunblind controller or sunblind actuator object). Its value is controlled by the sunblind button on the IRT 8080. A long press (> 1 second) of the button will set the network variable to {SET_STATE; 0,0; 65534} (up) or {SET_STATE; 100,0; 65534} (down), respectively. This allows the blinds to drive up and down. A short press (< 1 second) while driving the blinds will set the network variable to {SET_STOP; 0,0; 0,00}. This allows stopping the blinds at the current position. A short press (< 1 second) will set the network variable to {SET_UP; 127,5; 15} (up) or {SET_DOWN; 127,5; 15} (down), respectively. This allows rotating the blades of the sunblinds (open/close).

6.2 BACnet Interface and Application (LDALI-20X only)

Similar to the CEA-709 interface, the BACnet interface allows controlling DALI ballasts and access information from DALI ballasts and sensors via BACnet objects and properties. Additional properties allow configuring the built-in light controller applications (constant light, staircase lighting, etc.).

The objects can be grouped in the following categories:

DALI ballasts

- *Analog Output objects (see Section 6.2.2.11):*
 - Control output light level.
 - Configure DALI ballast parameters.
 - Configure light application parameters (staircase lighting, etc.).
- *Analog Input objects (see Section 6.2.2.12):* Output light level feedback.

- *Multi-State Output objects (see Section 6.2.2.16)*: Issue commands (start/stop emergency test or burn-in, change color temperature, etc.).
- *Analog Input objects (see Section 6.2.2.17)*: Battery status (self-contained emergency lighting).

DALI groups

- *Analog Output objects (see Section 6.2.2.11)*:
 - Control output light level.
 - Configure light application parameters (staircase lighting, etc.).
- *Analog Input objects (see Section 6.2.2.12)*: Output light level feedback.
- *Multi-State Output objects (see Section 6.2.2.13)*: Scene control.
- *Accumulator objects (see Section 6.2.2.14)*: Accumulated energy usage (calculated).
- *Analog Input objects (see Section 6.2.2.15)*: Status and health state of group.
- *Multi-State Output objects (see Section 6.2.2.16)*: Issue commands (start/stop emergency test or burn-in, change color temperature, etc.).
- *Analog Input objects (see Section 6.2.2.17)*: Battery status (self-contained emergency lighting).

DALI channels

- *Analog Output objects (see Section 6.2.2.11)*:
 - Control output light level.
 - Configure light application parameters (staircase lighting, etc.).
- *Analog Input objects (see Section 6.2.2.12)*: Output light level feedback.
- *Multi-State Output objects (see Section 6.2.2.13)*: Scene control.
- *Accumulator objects (see Section 6.2.2.14)*: Accumulated energy usage (calculated).
- *Analog Input objects (see Section 6.2.2.15)*: Status and health state of channel.
- *Multi-State Output objects (see Section 6.2.2.16)*: Issue commands (start/stop emergency test or burn-in, change color temperature, etc.).
- *Analog Input objects (see Section 6.2.2.17)*: Battery status (self-contained emergency lighting).

DALI sensors

- *Analog Input objects (see Section 6.2.3.2)*: Lux level sensor value.
- *Binary input objects (see Section 6.2.3.3)*: Occupancy sensor value.

Constant Light Controller

- *Loop objects (see Section 6.2.4.13)*

Which BACnet objects are available on the L-DALI's BACnet interface can be configured in the BACnet project settings in the LINX Configurator (see LINX Configurator User Manual [2]). Figure 84 shows the corresponding tab of the project settings.

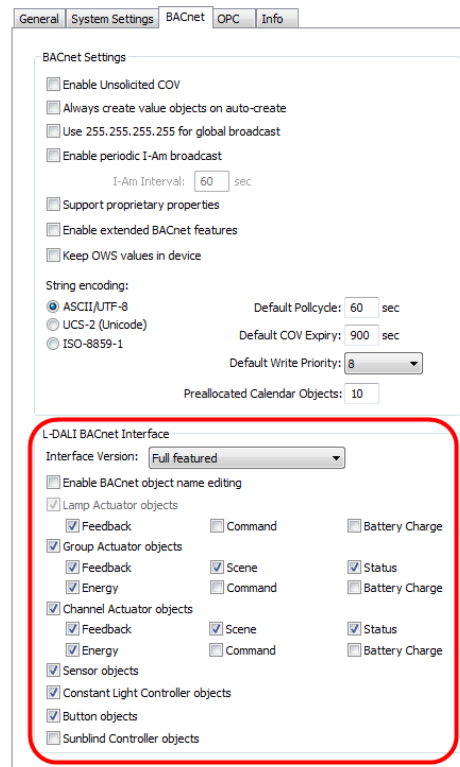

Figure 84: BACnet interface configuration.

All properties not specifically mentioned in the following sections behave as described by the BACnet standard.

The general BACnet objects and functions not specific to the L-DALI (Device Object, Protocol Parameters, Time Master, Backup & Restore, etc.) are described in the LOYTEC Device User Manual [1].

6.2.1 Interface Version

The BACnet interface can be used in two different modes:

Firmware version 1.x compatible interface

This interface is provided for backward compatibility with projects set up with a L-DALI with firmware version before 2.0.

Full featured interface

This interface is recommended for new projects.

The main difference between the two interface versions is the instance number layout. The “Full featured interface” offers better human readability. Further, new features in future firmware versions may be only available via the full featured interface.

The interface version can be configured via the LINX Configurator project settings (see LINX Configurator User Manual [2]).

6.2.2 Light Output Objects

There are three different types of light output objects:

- Objects related to DALI lamps (64 per channel).

- Objects related to DALI groups (16 per channel).
- Objects related to the DALI channels (1 per channel).

6.2.2.1 Control

The L-DALI offers different methods to control lamps.

Individual Control

Each lamp can be controlled individually via the *Present_Value* property of the corresponding Analog Output objects (see Section 6.2.2.11). Any new value received is transmitting to the corresponding DALI lamp in the dimming mode configured with the *Mode* property of the object (property *Fade_Time* or *Ramp_Rate* respectively is used to determine dim speed).

Alternatively, single lamps can be controlled via commands triggered via the *Present_Value* property of the corresponding Multi-State Output objects (see Section 6.2.2.16). The command allows recalling scene values on individual lamps or ramping the dim value up and down.

Group Control

Lamps belonging to a group can be controlled together by the following means:

- **Dimming:** Any new value received via the *Present_Value* property of the corresponding Analog Output objects (see Section 6.2.2.11) is transmitting to the corresponding DALI group in the dimming mode configured with the *Mode* property of the object (property *Fade_Time* or *Ramp_Rate* respectively is used to determine dim speed).
- **Scene control:** Using the *Present_Value* property of the corresponding Scene Multi-State Output objects (see Section 6.2.2.13) up to 16 DALI scenes can be saved and recalled. The states “*STORE SCENE x*” store the current light levels of all lamps of the group in the specified scene number ‘x’. Alternatively DALI scenes can be configured using the DALI Scenes page in the web interface (see LOYTEC Device User Manual [1]) or the DALI Scenes tab in the LINX Configurator (see LINX Configurator User Manual [2]). By setting the state to “*GO TO SCENE x*” previously stored scenes can be recalled. The state “*AUTOMATIC MODE*” will relinquish any manual override and (re-)activate a constant light controller linked to the group (see Section 6.2.4.4). Scenes can be deleted by a using the states “*REMOVE SCENE x*”. When a new scene is selected the lamp values are adjusted in fading mode (property *Fade_Time* is used).
- **Ramping:** Using the *Present_Value* property of the corresponding Command Multi-State Output objects (see Section 6.2.2.16) DALI groups can be dimmed up and down with a constant rate (ramping) configured in the property *Ramp_Rate* of the Analog Output object of the individual ballasts.

Channel Control

All lamps on the same DALI channel can be controlled together by the following means:

- **Dimming:** The *Present_Value* property of the corresponding Analog Output objects works in the same way as for lamps and groups but affects all lamps on a channel.

- **Scene control:** The *Present_Value* property of the corresponding Scene Multi-State Output objects works in the same way as for groups but affects all lamps on a channel.
- **Ramping:** The *Present_Value* property of the corresponding Command Multi-State Output objects works in the same way as for groups but affects all lamps on a channel.

6.2.2.2 Maximum and Minimum Light Level

For a dimmable lamp the maximum and minimum light level of a lamp can be configured via the properties *Min_Level* and *Max_Pres_Value* of the corresponding Analog Output object.

For a non-dimmable lamp set *Min_Level* = *Max_Pres_Value* = 100%.

6.2.2.3 Timing Parameters

Figure 85 shows the behavior of the lamp actuator if the light is switched on/off via one of the Analog Output objects. When the ON command is received, the lamp is switched to the specified value after the time *On_Delay_Time* has expired. When the lamp is already on and a new ON command is received the lamp is switched to the new value immediately. If the lamp is on and an OFF command is received the lamp is switched off after the time *Off_Delay_Time*.

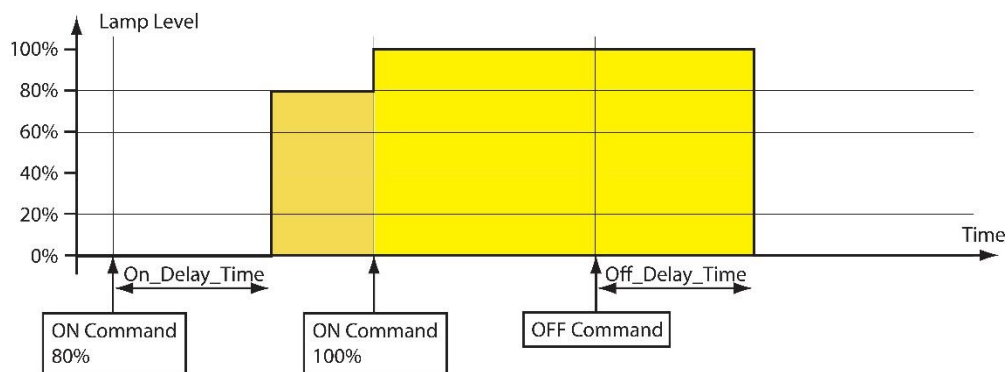

Figure 85: Timing Parameters.

For staircase lighting an automatic cutoff can be configured in *Auto_Off_Time* as shown in Figure 86. When this time expires, the lamp switches off automatically. To warn the user that the light is going to turn off, an off-warning delay (*Warn_Delay*) can be configured. During this time the light is dimmed to 50% of the previous level. For non-dimmable lights (*Min_Level*=*Max_Pres_Value*) the light is blinking.

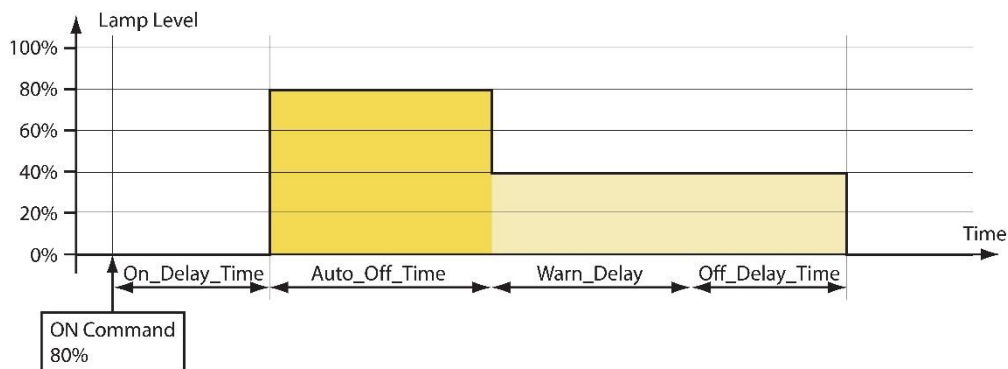

Figure 86: Timing Parameters with *Auto_Off_Time* and *Warn_Delay*.

The behavior of the auto-off timer can be modified with the property *Auto_Off_Mode*. If *Auto_Off_Mode* is set to *ENABLE_RESTART* or *ENABLE_RESTART_BREAK*, the auto-off timer can be restarted by a new ON command (see Figure 87). If *Auto_Off_Mode* is set *ENABLE_BREAK* or *ENABLE_RESTART_BREAK* the auto-off timer can be stopped before the time has expired by switching the light off via the corresponding *Present_Value* property (see Figure 88).

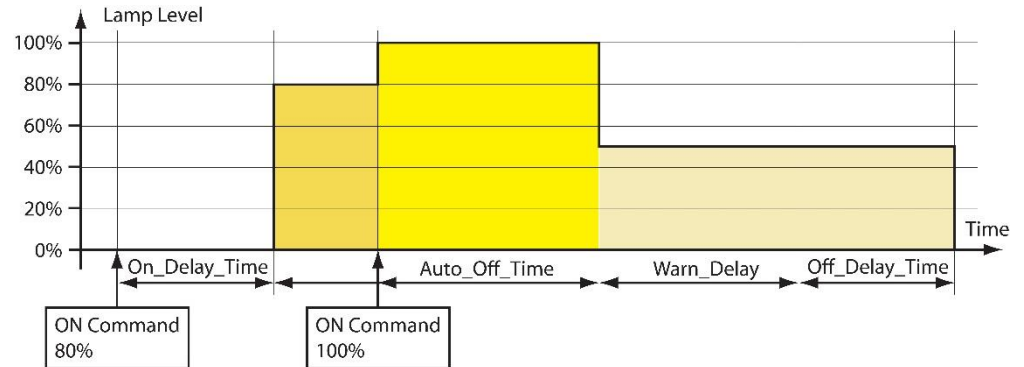

Figure 87: Timing Parameters (restart enabled).

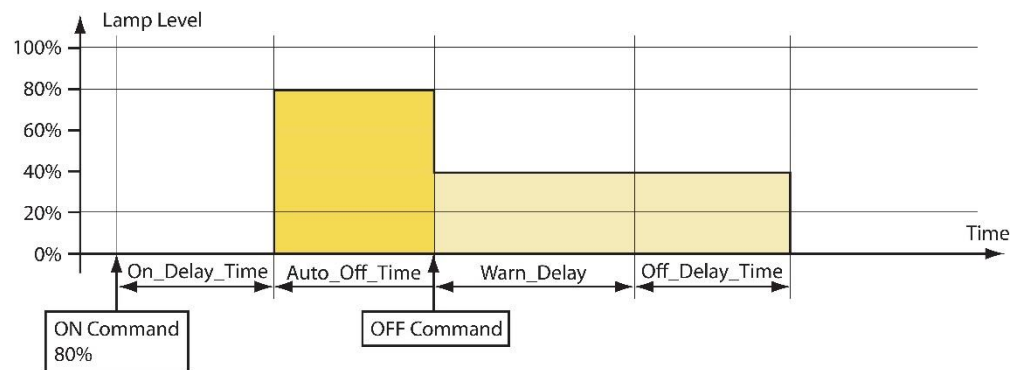

Figure 88: Timing Parameters (break enabled).

6.2.2.4 Feedback

The DALI lamp, group and channel each report the current state via the *Present_Value* of a feedback Analog Input (see Section 6.2.2.12).

All Analog Output objects report if they are in manual override mode by setting the *OVERRIDDEN* flag in the *Status_Flags* property.

6.2.2.5 Emergency Lights

The L-DALI supports emergency light testing of self-contained DALI emergency lights (Device Type 1, DT1). Tests can be started and stopped via the DALI Installation web-UI (see LOYTEC Device User Manual [1]) or the Command Multi-State Output object (see Section 6.2.2.16). Further, an automatic test schedule can be configured via the web-UI.

Whether the test is executed, pending or failed is shown in the status of the selected devices on the DALI Installation web-UI. A test is pending if its execution is delayed as the current state does not permit the execution of the test (e.g. battery not fully charged, other test being performed, etc.).

The result of the last test and other emergency light related status information is available via the following additional, emergency light related properties of the Channel Health Analog Input object (see Section 6.2.2.15):

- *Battery_Failure*: Report battery failure for each emergency light ballast.
- *Function_Test_Failure*: Report whether last function test failed for each emergency light ballast.
- *Duration_Test_Failure*: Report whether last function test failed for each emergency light ballast.

Test results will be stored in the appropriate emergency light test log (see LOYTEC Devices User Manual [1]).

In addition the current battery charge status of self-contained emergency lights is available via the Battery Status Analog Input object (see Section 6.2.2.17).

6.2.2.6 Status Monitoring

The L-DALI monitors the DALI lamps and reports any failure in the property *Device_Failure* of the Channel Health Analog Input object (see Section 6.2.2.15). In this property of type BIT STRING each bit corresponds to the lamp with the same index. In case of a failure the bit is set. Similar properties *Lamp_Failure* and *Ballast_Failure* are used to signal a lamp or a ballast failure reported by a ballast for each DALI ballast.

A device failure is reported if either

- bus power for the related DALI channel fails,
- the DALI ballast is not reachable via the DALI channel, or
- the DALI ballast reports a failure (e.g. lamp failure) in its DALI status register.

The *Present_Value* properties of the group and channel related Analog Input objects (see Section 6.2.2.15) reflect the percentage of failed ballasts in this group or channel respectively.

6.2.2.7 Statistics

The L-DALI reports the run hours and energy consumptions of the DALI lamps.

Run Hours

The L-DALI determines how long each DALI lamp was switched on. The value is reported via the property *Elapsed_Active_Time* of the Analog Output object for each lamp, group, and channel (see Section 6.2.2.11). If a lamp is replaced the run hours can be initialized by writing 0 to this property. The time and date of the last reset is stored in the property *Time_Of_Active_Time_Reset*.

The group related object reports the maximum run hours of all lamps in the groups via the property *Elapsed_Active_Time*.

The channel related object reports the maximum run hours of all lamps on the channel via the property *Elapsed_Active_Time*.

The run hours counter can be reset, either via the DALI Installation Web-UI (see LOYTEC Devices User Manual [1]) or via the Command Multi-State Output object (see Section 6.2.2.16).

Energy Consumption

The L-DALI device can calculate the energy consumption of the DALI lamps. For that purpose it needs to know the nominal power of all connected DALI lamps. If the configuration property *Nominal_Power* of a lamp related Analog Output object (see Section 6.2.2.11) is set to 0 (AUTO), the L-DALI tries to obtain the energy consumption from the DALI device. However, not all DALI ballasts support this proprietary extension. In this case the *Nominal_Power* *r* has to be configured with the nominal power of the ballast.

To reduce the number of objects the energy consumption is reported not separately for each lamp but for a whole group or channel. Accumulator objects (see Section 6.2.2.14) are used to report the sum of energy consumed by all lamps in a group or on a channel respectively. The energy consumption can be reset by writing to the *Value_Set* property of the Accumulator object

The energy consumption counter can be reset, either via the DALI Installation Web-UI (see LOYTEC Devices User Manual [1]) or via the Command Multi-State Output object (see Section 6.2.2.16).

6.2.2.8 Burn-In Function

Some lamps require a burn-in time during which they must not be dimmed. The burn-in mode can be activated/deactivated via the Web-UI. The burn-in time is defined by the property *Burn_In_Time* available via Analog Output objects corresponding to DALI channels (see Section 6.2.2.11). During this time the lamps will only be switched to on (100%) or off (0%) but not dimmed.

6.2.2.9 Fail Safe Functions

The light level a lamp adopts after power-up is defined in the property *Power_On_Level*. The light level a lamp adopts in case of a DALI system failure is defined in the configuration property *System_Failure_Level*. Both are available via Analog Output objects corresponding to DALI ballasts (see Section 6.2.2.11).

6.2.2.10 Colour Control

Controlling the color temperature of devices of type “colour control” (device type 8, DT8, “tuneable white”) is possible via the following methods:

- **absolute** by setting the colour temperature in degree Kelvin via the property *Colour_Temp* available on Analog Output objects corresponding to DALI ballasts, groups and channels (see Section 6.2.2.11).
- **relative** by ramping the colour temperature in the direction of warmer or cooler values via the Command Multi-State Output object corresponding to DALI ballasts, groups and channels (see Section 6.2.2.16).
- **absolute** by using the properties *Hue* and *Saturation* (see Section 6.2.2.11) available on Analog Output objects corresponding to DALI ballasts, groups and channels. Hue is an angular value, starting at the red primary at 0°, passing through the green primary at 120° and the blue primary at 240°, and then wrapping back to red at 360°. Saturation can be in the range of 0% to 100%. The controller converts the hue and saturation values given to the respective native DALI colour control values (xy-coordinate, RGBWAF or primary-N) as supported by the luminaire. This abstraction allows to use a control algorithm or user interface independent of the supported DALI colour control method.

- **via scenes** by using the Scene Multi-State Output object corresponding to DALI groups and channels (see Section 6.2.2.13). This object allows recalling DALI scenes. DALI scenes can contain lamp colour settings (for ballasts with DT8 support) as well as dim levels. These scenes can be defined using the DALI scenes tab in the LINX Configurator (see LINX Configurator User Manual [2]) or in the DALI scenes web-UI (see LOYTEC Device User Manual [1]). Note, that DALI scenes can be used to change lamp colour without affecting the dim level (and vice versa).

6.2.2.11 Analog Output Object – Control DALI ballast, group, or channel

This object type is used to control the dim level of DALI ballasts (see Table 11), DALI groups (see Table 12), or DALI channel (see Table 13). For DALI devices it also provides access to all its DALI parameters. Further, parameters for light controller applications are available (e.g. staircase lighting, on and off delays, off warning etc.).

Property Identifier	Property ID	Property Datatype	Conformance Code	Data Point
Object_Identifier	75	BACnetObjectIdentifier	R	
Object_Name	77	CharacterString	R	✓
Object_Type	79	BACnetObjectType	R	
Present_Value	85	REAL	W	✓
Description	28	CharacterString	W	
Device_Type	31	CharacterString	R	✓
Status_Flags	111	BACnetStatusFlags	R	
Event_State	36	BACnetEventState	R	
Reliability	103	BACnetReliability	R	✓
Out_Of_Service	81	BOOLEAN	W	
Units	117	BACnetEngineeringUnits	R	
Min_Pres_Value	69	REAL	R	
Max_Pres_Value	65	REAL	W	✓
Priority_Array	87	BACnetPriorityArray	R	
Relinquish_Default	104	REAL	W	
COV_Increment	22	REAL	W	
Time_Delay	113	Unsigned	W	
Notification_Class	17	Unsigned	W	
High_Limit	45	REAL	W	
Low_Limit	59	REAL	W	
Deadband	25	REAL	W	
Limit_Enable	52	BACnetLimitEnable	W	
Event_Enable	35	BACnetEventTransitionBits	W	
Acked_Transitions	0	BACnetEventTransitionBits	W	
Notify_Type	72	BACnetNotifyType	W	
Event_Time_Stamps	130	BACnetARRAY[3] of BACnetTimeStamp	R	
Profile_Name	168	CharacterString	R	
Power_On_Level	512	REAL	W	✓
System_Failure_Level	513	REAL	W	✓
Fade_Time	514	REAL	W	✓
Ramp_Rate	515	REAL	W	✓
Min_Level	516	REAL	W	✓
Groups	517	BIT STRING	W	✓
Nominal_Power	518	REAL	W	✓
Dim_Mode	520	BACnetDimMode	W	✓
On_Delay_Time	521	Unsigned	W	✓
Off_Delay_Time	522	Unsigned	W	✓
Warn_Delay	523	Unsigned	W	✓
Auto_Off_Time	524	Unsigned	W	✓
Auto_Off_Mode	526	BACnetAutoOffMode	W	✓
Elapsed_Active_Time	527	Unsigned	W	✓
Time_Of_Active_Time_Reset	528	BACnetDateTime	R	✓
Colour_Temp	567	REAL	W	✓
Hue	569	REAL	W	✓

Property Identifier	Property ID	Property Datatype	Conformance Code	Data Point
Saturation	570	REAL	W	✓

Table 11: Properties of the Analog Output object used to control DALI ballasts.

Property Identifier	Property ID	Property Datatype	Conformance Code	Data Point
Object_Identifier	75	BACnetObjectIdentifier	R	
Object_Name	77	CharacterString	R	✓
Object_Type	79	BACnetObjectType	R	
Present_Value	85	REAL	W	✓
Description	28	CharacterString	W	
Device_Type	31	CharacterString	R	
Status_Flags	111	BACnetStatusFlags	R	
Event_State	36	BACnetEventState	R	
Reliability	103	BACnetReliability	R	✓
Out_Of_Service	81	BOOLEAN	W	
Units	117	BACnetEngineeringUnits	R	
Min_Pres_Value	69	REAL	R	
Max_Pres_Value	65	REAL	W	
Priority_Array	87	BACnetPriorityArray	R	
Relinquish_Default	104	REAL	W	
COV_Increment	22	REAL	W	
Time_Delay	113	Unsigned	W	
Notification_Class	17	Unsigned	W	
High_Limit	45	REAL	W	
Low_Limit	59	REAL	W	
Deadband	25	REAL	W	
Limit_Enable	52	BACnetLimitEnable	W	
Event_Enable	35	BACnetEventTransitionBits	W	
Acked_Transitions	0	BACnetEventTransitionBits	W	
Notify_Type	72	BACnetNotifyType	W	
Event_Time_Stamps	130	BACnetARRAY[3] of BACnetTimeStamp	R	
Profile_Name	168	CharacterString	R	
Dim_Mode	520	BACnetDimMode	W	✓
On_Delay_Time	521	Unsigned	W	✓
Off_Delay_Time	522	Unsigned	W	✓
Warn_Delay	523	Unsigned	W	✓
Auto_Off_Time	524	Unsigned	W	✓
Auto_Off_Mode	526	BACnetAutoOffMode	W	✓
Elapsed_Active_Time	527	Unsigned	W	✓
Time_Of_Active_Time_Reset	528	BACnetDateTime	R	✓
Colour_Temp	567	REAL	W	✓
Hue	569	REAL	W	✓
Saturation	570	REAL	W	✓

Table 12: Properties of the Analog Output object used to control DALI groups.

Property Identifier	Property ID	Property Datatype	Conformance Code	Data Point
Object_Identifier	75	BACnetObjectIdentifier	R	
Object_Name	77	CharacterString	R	✓
Object_Type	79	BACnetObjectType	R	
Present_Value	85	REAL	W	✓
Description	28	CharacterString	W	
Device_Type	31	CharacterString	R	
Status_Flags	111	BACnetStatusFlags	R	
Event_State	36	BACnetEventState	R	
Reliability	103	BACnetReliability	R	✓
Out_Of_Service	81	BOOLEAN	W	
Units	117	BACnetEngineeringUnits	R	
Min_Pres_Value	69	REAL	R	
Max_Pres_Value	65	REAL	W	
Priority_Array	87	BACnetPriorityArray	R	
Relinquish_Default	104	REAL	W	
COV_Increment	22	REAL	W	
Time_Delay	113	Unsigned	W	
Notification_Class	17	Unsigned	W	
High_Limit	45	REAL	W	
Low_Limit	59	REAL	W	
Deadband	25	REAL	W	
Limit_Enable	52	BACnetLimitEnable	W	
Event_Enable	35	BACnetEventTransitionBits	W	
Acked_Transitions	0	BACnetEventTransitionBits	W	
Notify_Type	72	BACnetNotifyType	W	
Event_Time_Stamps	130	BACnetARRAY[3] of BACnetTimeStamp	R	
Profile_Name	168	CharacterString	R	
Burn_In_Time	519	Unsigned	W	✓
Dim_Mode	520	BACnetDimMode	W	✓
On_Delay_Time	521	Unsigned	W	✓
Off_Delay_Time	522	Unsigned	W	✓
Warn_Delay	523	Unsigned	W	✓
Auto_Off_Time	524	Unsigned	W	✓
Auto_Off_Mode	526	BACnetAutoOffMode	W	✓
Elapsed_Active_Time	527	Unsigned	W	✓
Time_Of_Active_Time_Reset	528	BACnetDateTime	R	✓
Colour_Temp	567	REAL	W	✓
Hue	569	REAL	W	✓
Saturation	570	REAL	W	✓

Table 13: Properties of the Analog Output object used to control DALI channels.

Object_Identifier (Read-Only)

The default instance number is ABCC, where “A” is 0 for the objects associated with DALI devices and 1 for the objects associated with DALI groups, and 2 with DALI channels, “B”

is the DALI interface number (0-3) in decimal, and “CC” is the DALI device number (00-63) or the DALI group address (00-15) respectively in decimal (00 for DALI channels). Examples: Ballast 3 on channel 2 has the instance number 103, Group 5 on channel 1 has the instance number 1005, and channel 4 has the instance number 2300.

In compatibility mode the instance number is 0x0ABBCC, where “A” is 0 for the objects associated with DALI devices and 1 for the objects associated with DALI groups, and 2 with DALI channels, “BB” is the DALI interface number (0-3) in hex, and “CC” is the DALI device number (0-63) or the DALI group address (0-15) respectively in hex. Examples: Ballast 3 on channel 2 has the instance number 0x000303 (771), Group 5 on channel 1 has the instance number 0x010205 (66053), and channel 4 has the instance number 0x020300 (131840).

Object_Name (Read-Only)

This property holds the name of the lamp/group/channel. It can be changed via the Web-UI.

Object_Type (Read-Only)

The value of this property is ANALOG_OUTPUT (1).

Present_Value (Read/Write)

This property, of type REAL, indicates the linearized percentage (0..100.00%) of the device’s desired light output; 0 being off, 1 being dimmest, 100 brightest. It is used to dim the corresponding DALI ballast, group, or channel.

Depending on the *Dim_Mode* property, a write to this property results in a DALI “DIRECT ARC POWER CONTROL” command (fade) or a series of UP or DOWN commands to the device, group or channel respectively.

Description (Read/Write)

This property can be configured via BACnet. It serves documentation purposes only.

Device_Type (Read-Only)

This property contains the DALI device type (e.g. “*low voltage halogen lamp*”) for objects mapping to DALI devices, “*DALI group*” for objects mapping to DALI groups and “*DALI channel*” for objects mapping to DALI channels.

Status_Flags (Read-Only)

Of the four flags the flags IN_ALARM, FAULT, and OUT_OF_SERVICE are linked to the state of the corresponding properties *Event_State*, *Reliability* and *Out_Of_Service* as described by the standard.

OVERRIDDEN Logical TRUE (1) if the associated DALI channel is controlled via the button interface (see Section 4.5.2), FALSE otherwise.

Reliability (Read-Only)

The *Reliability* property for this object type may have any of the following values:

NO_FAULT_DETECTED No fault was detected.

NO_OUTPUT A lamp failure was detected (for groups and channels if at least one lamp failure in the group/on the channel was detected).

COMMUNICATION_FAILURE	Ballast offline (for groups and channels if at least one ballast is offline in the group/on the channel).
UNRELIABLE_OTHER	Other failure detected (e.g. DALI device type specific error, for groups and channels if at least one ballast in the group/on the channel reports a failure)

Units (Read-Only)

The value of this property is 98 (percent).

Min_Pres_Value (Read-Only)

The value of this property is 0.

Max_Pres_Value (Read/Write)

For objects associated to DALI lamps this property is read/write. Its maximum value is 100. It is mapped to the DALI register MAX_LEVEL of the corresponding ballast.

For DALI groups and channels this value is always 100 and read only.

Profile_Name (Read-only)

This property has the following values:

- DALI lamps: “178-<http://www.loytec.com/xsd/DALILampActuator/v1>”
- DALI groups: “178-<http://www.loytec.com/xsd/DALIGroupActuator/v1>”
- DALI channels: “178-<http://www.loytec.com/xsd/DALIChannelActuator/v1>”

Power_On_Level (Read/Write)

The value of this proprietary property (property ID 512) corresponds to the “POWER ON LEVEL” in the DALI device. A value of NaN corresponds to MASK.

Only present if the object is associated with a DALI lamp.

System_Failure_Level (Read/Write)

The value of this proprietary property (property ID 513) corresponds to the “SYSTEM FAILURE LEVEL” in the DALI device. A value of NaN corresponds to MASK.

Only present if the object is associated with a DALI lamp.

Fade_Time (Read/Write)

The value of this proprietary property (property ID 514) corresponds to the “FADE TIME” in the DALI device. It gives the time in seconds. The FADE TIME closest to the written value will be used.

Only present if the object is associated with a DALI lamp.

Ramp_Rate (Read/Write)

The value of this proprietary property (property ID 515) corresponds to the “FADE RATE” in the DALI device. It gives the fade rate in percent per seconds for ramping. The FADE RATE closest to the written value will be used.

Only present if the object is associated with a DALI lamp.

Min_Level (Read/Write)

The value of this proprietary property (property ID 516) corresponds to “MIN LEVEL” in the DALI device. It must be in the range $0 < \text{Min_Level} \leq 100$.

Only present if the object is associated with a DALI lamp.

Groups (Read/Write)

The value of this proprietary property (property ID 517) is a 16-bit wide BIT STRING. It corresponds to the “GROUPS” of the DALI device. It defines the group membership of a lamp. Each bit corresponds to the group of the same index. If the bit is set, the lamp is member of the group.

Only present if the object is associated with a DALI lamp.

Nominal_Power (Read/Write)

This proprietary property (property ID 518) is used to specify the nominal power of a DALI ballast. A value of 0 is used to specify AUTO. In this case the nominal power is read from the ballast (if available).

Only present if the object is associated with a DALI lamp.

Burn_In_Time (Read/Write)

This proprietary property (property ID 519) is used to configure the burn in time for the channel. The burn-in mode can be activated/deactivated via the Web-UI.

Only present if the object is associated with a DALI channel.

Dim_Mode (Read/Write)

The value of this proprietary property (property ID 520) is used to specify whether to use ramping (1) or fading (0) when changing the current dim level by writing to the *Present_Value* property.

In case of ramping a constant dim rate is used. Thus, the duration of the dim process depends on the difference between start and target value.

Fading is based on a constant dim duration. Thus, the duration of the dim process does not depend on the difference between start and target value.

On_Delay_Time (Read/Write)

This proprietary property (property ID 521) is used to configure an on-delay time in seconds.

Off_Delay_Time (Read/Write)

This proprietary property (property ID 522) is used to configure an off-delay time in seconds.

Warn_Delay (Read/Write)

This proprietary property (property ID 523) is used to configure an off-warning time in seconds. It defines the time during which the user will be notified that the light will be

switched off shortly. During this time, the light is dimmed to 50% of the current level. Lamps which cannot be dimmed (*Min_Level = Max_Pres_Value*) blink during this time.

Auto_Off_Time (Read/Write)

This proprietary property (property ID 524) is used to configure an auto-off time in seconds. It determines the delay after which the lamp output is switched off automatically. The timer is started after receiving a lamp ON command via the *Present_Value* property

The property *Auto_Off_Mode* modifies the behavior of the auto-off timer.

Auto_Off_Mode (Read/Write)

The value of this proprietary property (property ID 526) determines the behavior of the auto-off timer. Possible values are:

DISABLE_ALL (0)	ENABLE_RESTART and ENABLE_BREAK not set.
ENABLE_BREAK (1)	The auto-off-timer can be interrupted by writing to the <i>Present_Value</i> .
ENABLE_RESTART (2)	The auto-off-timer is restarted whenever the <i>Present_Value</i> is written.
ENABLE_RESTART_BREAK (3)	ENABLE_RESTART and ENABLE_BREAK set.

Elapsed_Active_Time (Read/Write)

The value of this proprietary property (property ID 527) gives the accumulated time in seconds, which the corresponding DALI lamp was switched on. For groups or channels it gives the maximum time of all lamps in the group/channel. When writing 0 to this property the value is reset. For groups and channels the value of all lamps in the group/channel are reset.

Time_Of_Active_Time_Reset (Read-Only)

The value of this proprietary property (property ID 528) give the time and date the *Elapsed_Active_Time* property was last reset.

Colour_Temp (Read/Write)

This proprietary property (property ID 567) can be used to control the color temperature of devices of type “colour control” (device type 8, according to IEC 62386-209). The value of the property gives the color temperature in Kelvin. On objects corresponding to groups and channels it allows to control the color temperature of all lights in the group or on the channel, respectively, at once.

Hue, Saturation (Read/Write)

The proprietary properties Hue (property ID 569) and Saturation (property ID 570) can be used to control the light color of devices of type “colour control” (device type 8, according to IEC 62386-209) according to the HSV color model. Hue is an angular value, starting at the red primary at 0°, passing through the green primary at 120° and the blue primary at 240°, and then wrapping back to red at 360°. Saturation can be in the range of 0% to 100%.

Intrinsic reporting

This object supports all properties required for intrinsic reporting. Per default only fault alarms are enabled.

6.2.2.12 Analog Input Object – Feedback from DALI ballast, group, or channel

This object is used to give feedback on the current dim level of DALI ballasts, DALI groups, or DALI channels (see Table 14).

Property Identifier	Property ID	Property Datatype	Conformance Code	Data Point
Object_Identifier	75	BACnetObjectIdentifier	R	
Object_Name	77	CharacterString	R	✓
Object_Type	79	BACnetObjectType	R	
Present_Value	85	REAL	R	✓
Device_Type	31	CharacterString	R	
Status_Flags	111	BACnetStatusFlags	R	
Event_State	36	BACnetEventState	R	
Reliability	103	BACnetReliability	R	✓
Out_Of_Service	81	BOOLEAN	W	
Units	117	BACnetEngineeringUnits	R	
Min_Pres_Value	69	REAL	R	
Max_Pres_Value	65	REAL	R	
COV_Increment	22	REAL	W	
Profile_Name	168	CharacterString	R	

Table 14: Properties of the Analog Input object providing feedback from DALI ballasts, groups, and channels.

Object_Identifier (Read-Only)

The instance number is equal to the instance number of the corresponding Analog Output object (see Section 6.2.2.11).

Object_Name (Read-Only)

This property holds the value of the *Object_Name* of the associated Analog Output object with the addition “*Feedback*”.

Object_Type (Read-Only)

The value of this property is ANALOG_INPUT (0).

Present_Value (Read-Only)

This property, of type REAL, indicates the linearized percentage (0..100.00%) of the DALI device’s, group’s or channel’s current light output.

Device_Type (Read-Only)

This property contains the value “*Actual Dim Level*”.

Status_Flags (Read-Only)

Of the four flags the flags IN_ALARM, FAULT, and OUT_OF_SERVICE are linked to the state of the corresponding properties *Event_State*, *Reliability* and *Out_Of_Service* as described by the standard.

OVERRIDDEN Always FALSE.

Reliability (Read-Only)

The *Reliability* property for this object type may have any of the following values:

NO_FAULT_DETECTED	No fault was detected.
NO_SENSOR	A lamp failure was detected (for groups and channels if at least one lamp failure in the group/on the channel was detected).
COMMUNICATION_FAILURE	Ballast offline (for groups and channels if at least one ballast is offline in the group/on the channel).
UNRELIABLE_OTHER	Other failure detected (e.g. DALI device type specific error, for groups and channels if at least one ballast in the group/on the channel reports a failure)

Units (Read-Only)

The value of this property is 98 (percent).

Min_Pres_Value (Read-Only)

The value of this property is 0.

Max_Pres_Value (Read-Only)

The value of this property is 100.

Profile_Name (Read-only)

This property has the following values:

- DALI lamps: “178-<http://www.loytec.com/xsd/DALILampActuatorFeedback/v1>”
- DALI groups: “178-<http://www.loytec.com/xsd/DALIGroupActuatorFeedback/v1>”
- DALI channels: “178-<http://www.loytec.com/xsd/DALIChannelActuatorFeedback/v1>”

6.2.2.13 Multi-State Output Object – Scene Control for DALI group or channel

This object is used to control the dim level of DALI groups and DALI channels via scene control. It has states for scene learning, recalling and clearing (see Table 15).

Property Identifier	Property ID	Property Datatype	Conformance Code	Data Point
Object_Identifier	75	BACnetObjectIdentifier	R	
Object_Name	77	CharacterString	R	✓
Object_Type	79	BACnetObjectType	R	
Present_Value	85	Unsigned	W	✓
Status_Flags	111	BACnetStatusFlags	R	
Event_State	36	BACnetEventState	R	
Out_Of_Service	81	BOOLEAN	W	
Number_Of_States	74	Unsigned	R	
State_Text	110	BACnetARRAY[N]of CharacterString	W	
Priority_Array	87	BACnetPriorityArray	R	
Relinquish_Default	104	Unsigned	R	
Profile_Name	168	CharacterString	R	

Table 15: Properties of the Multi-State Output object used for scene control of DALI groups and channels.

Object_Identifier (Read-Only)

The instance number is equal to the instance number of the corresponding Analog Output object (see Section 6.2.2.11).

Object_Name (Read-Only)

This property holds the value of the *Object_Name* of the associated Analog Output object with the addition “*Scene*”.

Object_Type (Read-Only)

The value of this property is MULTISTATE_OUTPUT (14).

Present_Value (Read/Write)

The *Present_Value* property can have the following values:

GO TO SCENE X (1-16): Where X is 0-15. Results in recalling the DALI scene X by sending the DALI “GO TO SCENE” command to the DALI group address or DALI broadcast address, which is associated with this Multi-State Output object.

STORE SCENE X (17-32): Where X is 0-15. Results in the current values being stored as scene X by sending the DALI “STORE THE DTR AS SCENE” command to the DALI group address or DALI broadcast address, which is associated with this Multi-State Output object.

REMOVE SCENE X (33-48): Where X is 0-15. Results in scene X being erased by sending the DALI “REMOVE FROM SCENE” command to the DALI group address or DALI broadcast address, which is associated with this Multi-State Output object.

AUTOMATIC MODE (49): Relinquish any manual override and (re-)activate constant light controller linked to the group (see Section 6.2.4.4).

Status_Flags (Read-Only)

Of the four flags the flags IN_ALARM, FAULT, and OUT_OF_SERVICE are linked to the state of the corresponding properties *Event_State*, *Reliability* and *Out_Of_Service* as described by the standard.

OVERRIDDEN Logical TRUE (1) if the associated DALI channel is controlled via the button interface (see Section 4.5.2), FALSE otherwise.

Reliability (Read-Only)

The *Reliability* property of this object type may have any of the following values:

NO_FAULT_DETECTED No fault was detected.

Number_Of_States (Read-Only)

This property has the value 49.

State_Text (Read/Write)

Per default this property contains the strings “GO TO SCENE X”, “STORE SCENE X”, and “REMOVE SCENE X” respectively.

Profile_Name (Read-only)

This property has the following values:

- DALI groups: “178-http://www.loytec.com/xsd/DALIGroupSceneCtrl/v1”
- DALI channels: “178-http://www.loytec.com/xsd/DALIChannelSceneCtrl/v1”

6.2.2.14 Accumulator Object – Energy usage of DALI group or channel

This object is used to represent the accumulated energy usage of DALI groups and channels (see Table 16).

Property Identifier	Property ID	Property Datatype	Conformance Code	Data Point
Object_Identifier	75	BACnetObjectIdentifier	R	
Object_Name	77	CharacterString	R	✓
Object_Type	79	BACnetObjectType	R	
Present_Value	85	UNSIGNED	R	✓
Device_Type	31	CharacterString	R	
Status_Flags	111	BACnetStatusFlags	R	
Event_State	36	BACnetEventState	R	
Reliability	103	BACnetReliability	R	✓
Out_Of_Service	81	BOOLEAN	W	
Scale	187	BACnetScale	R	
Units	117	BACnetEngineeringUnits	R	
Max_Pres_Value	65	Unsigned	R	
Value_Change_Time	192	BACnetDateTime	R	
Value_Before_Change	190	Unsigned	R	
Value_Set	191	Unsigned	W	
Time_Delay	113	Unsigned	W	
Notification_Class	17	Unsigned	W	
High_Limit	45	REAL	W	
Low_Limit	59	REAL	W	
Deadband	25	REAL	W	
Limit_Enable	52	BACnetLimitEnable	W	
Event_Enable	35	BACnetEventTransitionBits	W	
Acked_Transitions	0	BACnetEventTransitionBits	W	
Notify_Type	72	BACnetNotifyType	W	
Event_Time_Stamps	130	BACnetARRAY[3] of BACnetTimeStamp	R	
Profile_Name	168	CharacterString	R	

Table 16: Properties of the Accumulator object representing the accumulated energy usage of DALI groups or channels.

Object_Identifier (Read-Only)

The instance number is equal to the instance number of the corresponding Analog Output object (see Section 6.2.2.11).

Object_Name (Read-Only)

This property holds the value of the *Object_Name* of the associated Analog Output object with the addition “Energy”.

Object_Type (Read-Only)

The value of this property is ACCUMULATOR (23).

Present_Value (Read-Only)

The value of this property, of type UNSIGNED, indicates the accumulated energy usage in Wh. For objects associated to DALI groups/channels this property reports the sum of the accumulated energy usage of all ballasts in the DALI group/channel.

For calculating the energy usage the nominal power of the affected DALI lamps must be known (see Property *Nominal_Power*, Section 6.2.2.11). The value of this property is just a calculated value and thus is not suitable for billing energy usage.

Device_Type (Read-Only)

This property contains the value “*Accumulated Energy Usage*”.

Status_Flags (Read-Only)

Of the four flags the flags IN_ALARM, FAULT, and OUT_OF_SERVICE are linked to the state of the corresponding properties *Event_State*, *Reliability* and *Out_Of_Service* as described by the standard.

OVERRIDDEN Always FALSE.

Reliability (Read-Only)

The *Reliability* property for this object type may have any of the following values:

NO_FAULT_DETECTED No fault was detected.

UNRELIABLE_OTHER Other failure detected.

Scale (Read-Only)

The value of this property is INTEGER 1.

Units (Read-Only)

The value of this property is 18 (watt-hours).

Max_Pres_Value (Read-Only)

The value of this property is 4.294.967.295 (maximum unsigned 32-bit value).

Value_Set (Read/Write)

This property behaves as defined by the BACnet standard. Resetting the accumulator value is possible via the *Value_Set* property (*Value_Set* is writeable, *Value_Before_Change* is not writeable).

Profile_Name (Read-only)

The value of this property is “178-<http://www.loytec.com/xsd/LightEnergyAccumulator/v1>”.

Intrinsic reporting

The object supports all properties required for intrinsic reporting. Per default no alarms are enabled.

6.2.2.15 Analog Input Object – Health State of DALI group or channel

This object is used to represent the health state of DALI groups (see Table 17) or DALI channels (see Table 18).

Property Identifier	Property ID	Property Datatype	Conformance Code	Data Point
Object_Identifier	75	BACnetObjectIdentifier	R	
Object_Name	77	CharacterString	R	✓
Object_Type	79	BACnetObjectType	R	
Present_Value	85	REAL	R	✓
Status_Flags	111	BACnetStatusFlags	R	
Event_State	36	BACnetEventState	R	
Reliability	103	BACnetReliability	R	
Out_Of_Service	81	BOOLEAN	W	
Units	117	BACnetEngineeringUnits	R	
Min_Pres_Value	69	REAL	R	
Max_Pres_Value	65	REAL	R	
COV_Increment	22	REAL	W	
Time_Delay	113	Unsigned	W	
Notification_Class	17	Unsigned	W	
High_Limit	45	REAL	W	
Low_Limit	59	REAL	W	
Deadband	25	REAL	W	
Limit_Enable	52	BACnetLimitEnable	W	
Event_Enable	35	BACnetEventTransitionBits	W	
Acked_Transitions	0	BACnetEventTransitionBits	W	
Notify_Type	72	BACnetNotifyType	W	
Event_Time_Stamps	130	BACnetARRAY[3] of BACnetTimeStamp	R	
Profile_Name	168	CharacterString	R	

Table 17: Properties of the Analog Input object representing the health state of a DALI group.

Property Identifier	Property ID	Property Datatype	Conformance Code	Data Point
Object_Identifier	75	BACnetObjectIdentifier	R	
Object_Name	77	CharacterString	R	✓
Object_Type	79	BACnetObjectType	R	
Present_Value	85	REAL	R	✓
Status_Flags	111	BACnetStatusFlags	R	
Event_State	36	BACnetEventState	R	
Reliability	103	BACnetReliability	R	
Out_Of_Service	81	BOOLEAN	W	
Units	117	BACnetEngineeringUnits	R	
Min_Pres_Value	69	REAL	R	
Max_Pres_Value	65	REAL	R	
COV_Increment	22	REAL	W	
Time_Delay	113	Unsigned	W	
Notification_Class	17	Unsigned	W	
High_Limit	45	REAL	W	
Low_Limit	59	REAL	W	
Deadband	25	REAL	W	
Limit_Enable	52	BACnetLimitEnable	W	
Event_Enable	35	BACnetEventTransitionBits	W	
Acked_Transitions	0	BACnetEventTransitionBits	W	
Notify_Type	72	BACnetNotifyType	W	
Event_Time_Stamps	130	BACnetARRAY[3] of BACnetTimeStamp	R	
Profile_Name	168	CharacterString	R	
Device_Failure	529	BIT STRING	R	✓
Ballast_Failure	530	BIT STRING	R	✓
Lamp_Failure	531	BIT STRING	R	✓
Battery_Failure	532	BIT STRING	R	✓
Function_Test_Failure	533	BIT STRING	R	✓
Duration_Test_Failure	534	BIT STRING	R	✓
Bus_Power	563	BACnetBinaryPV	R	✓
Bus_Power_Failure	564	BACnetBinaryPV	R	✓
Bus_Power_Overload	565	BACnetBinaryPV	R	✓

Table 18: Properties of the Analog Input object representing the health state of a DALI channel.

Object_Identifier (Read-Only)

The default instance number is ABCC, where “A” is 3 for the objects associated with DALI groups, and 4 with DALI channels, “B” is the DALI interface number (0-3) in decimal, and “CC” is the DALI group address (00-15) in decimal (00 for DALI channels). Examples: Group 5 on channel 1 has the instance number 3005, and channel 4 has the instance number 4300.

Object_Name (Read-Only)

This property holds the value of the *Object_Name* of the associated Analog Output object with the addition “*Status*”.

Object_Type (Read-Only)

The value of this property is ANALOG_INPUT (0).

Present_Value (Read-Only)

This property reports the percentage of failed ballasts on the corresponding group/channel.

A ballast failure is reported if either

- The bus power for the related DALI channel fails,
- the DALI ballast is not reachable via the DALI channel, or
- the DALI ballast reports a failure (e.g. lamp failure) in its DALI status register.

Status_Flags (Read-Only)

Of the four flags the flags IN_ALARM, FAULT, and OUT_OF_SERVICE are linked to the state of the corresponding properties *Event_State*, *Reliability* and *Out_Of_Service* as described by the standard.

OVERRIDDEN Always FALSE.

Reliability (Read-Only)

The *Reliability* property for this object type may have any of the following values:

NO_FAULT_DETECTED No fault was detected.

Units (Read-Only)

The value of this property is 98 (percent).

Min_Pres_Value (Read-Only)

The value of this property is 0.

Max_Pres_Value (Read-Only)

The value of this property is 100.

Profile_Name (Read-only)

This property has the following values:

- DALI groups: “178-http://www.loytec.com/xsd/DALIGroupActuatorStatus/v1”
- DALI channels: “178-http://www.loytec.com/xsd/DALIChannelActuatorStatus/v1”

Device_Failure (Read-Only)

The value of this proprietary property (property ID 529) is a 64-bit wide BIT STRING. It contains one bit for each ballast on the channel. If the device fails (offline or failure reported via DALI status bits) the bit is set, otherwise it is cleared.

Only present if the object is associated with a DALI channel.

Ballast_Failure (Read-Only)

The value of this proprietary property (property ID 530) is a 64-bit wide BIT STRING. It contains one bit for each ballast on the channel. If the device reports a ballast failure the bit is set, otherwise it is cleared.

Only present if the object is associated with a DALI channel.

Lamp_Failure (Read-Only)

The value of this proprietary property (property ID 531) is a 64-bit wide BIT STRING. It contains one bit for each ballast on the channel. If the device reports a lamp failure the bit is set, otherwise it is cleared.

Only present if the object is associated with a DALI channel.

Battery_Failure (Read-Only)

The value of this proprietary property (property ID 532) is a 64-bit wide BIT STRING. It contains one bit for each ballast on the channel. If the device reports a battery failure (self-contained emergency lights only) the bit is set, otherwise it is cleared.

Only present if the object is associated with a DALI channel.

Function_Test_Failure (Read-Only)

The value of this proprietary property (property ID 533) is a 64-bit wide BIT STRING. It contains one bit for each ballast on the channel. If the device reports a function test failure (self-contained emergency lights only) the bit is set, otherwise it is cleared.

Only present if the object is associated with a DALI channel.

Duration_Test_Failure (Read-Only)

The value of this proprietary property (property ID 534) is a 64-bit wide BIT STRING. It contains one bit for each ballast on the channel. If the device reports a duration test failure (self-contained emergency lights only) the bit is set, otherwise it is cleared.

Only present if the object is associated with a DALI channel.

Bus_Power (Read-Only)

The value of this proprietary property (property ID 563) is *enabled* (active) if the internal bus power is active for the channel and *disabled* (inactive) if not.

Bus_Power_Failure (Read-Only)

The value of this proprietary property (property ID 564) is *failed* (active) if a DALI bus power failure was detected on the channel or *ok* (inactive) if the DALI bus power is present. A bus power failure is detected independent on whether an internal or an external DALI bus power supply is used.

Bus_Power_Overload (Read-Only)

The value of this proprietary property (property ID 565) is *overload* (active) if the internal DALI bus power failed due to an overload or *normal* (inactive) if the internal DALI bus power is either disabled/not present or working properly.

Intrinsic reporting

The object supports all properties required for intrinsic reporting. Per default no alarms are enabled.

6.2.2.16 Multi-State Output Object – Commands for DALI ballast, group, or channel

This object is used to issue commands to DALI ballasts, DALI groups and DALI channels. It has states for scene control, burn-in mode, resetting run-hours and energy counters, emergency light testing, relative dimming (up/down) and changing the colour temperature (see Table 19).

Property Identifier	Property ID	Property Datatype	Conformance Code	Data Point
Object_Identifier	75	BACnetObjectIdentifier	R	
Object_Name	77	CharacterString	R	✓
Object_Type	79	BACnetObjectType	R	
Present_Value	85	Unsigned	W	✓
Status_Flags	111	BACnetStatusFlags	R	
Event_State	36	BACnetEventState	R	
Out_Of_Service	81	BOOLEAN	W	
Number_Of_States	74	Unsigned	R	
State_Text	110	BACnetARRAY[N]of CharacterString	W	
Priority_Array	87	BACnetPriorityArray	R	
Relinquish_Default	104	Unsigned	R	
Profile_Name	168	CharacterString	R	

Table 19: Properties of the Multi-State Output object used for commanding DALI devices, groups and channels.

Object_Identifier (Read-Only)

The default instance number is ABCC, where “A” is 3 for the objects associated with DALI devices and 4 for the objects associated with DALI groups, and 5 with DALI channels, “B” is the DALI interface number (0-3) in decimal, and “CC” is the DALI device number (00-63) or the DALI group address (00-15) respectively in decimal (00 for DALI channels). Examples: Group 5 on channel 1 has the instance number 4005, and channel 4 has the instance number 5300.

Object_Name (Read-Only)

This property holds the value of the *Object_Name* of the associated Analog Output object with the addition “*Command*”.

Object_Type (Read-Only)

The value of this property is MULTISTATE_OUTPUT (14).

Present_Value (Read/Write)

The *Present_Value* property can have the following values:

NO COMMAND (1): No command is executed.

RECALL SCENE XX (2-17): Where XX is 00-15. Results in recalling the DALI scene XX by sending the DALI “GO TO SCENE” command to the DALI device, DALI group address or DALI broadcast address, which is associated with this Multi-State Output object.

STORE SCENE XX (18-33): Where XX is 0-15. Results in the current values being stored as scene XX by sending the DALI “STORE THE DTR AS SCENE” command to the DALI device, DALI group address or DALI broadcast address, which is associated with this Multi-State Output object.

CLEAR SCENE XX (34-49): Where XX is 0-15. Results in scene XX being erased by sending the DALI “REMOVE FROM SCENE” command to the DALI device, DALI group address or DALI broadcast address, which is associated with this Multi-State Output object.

START BURN IN (50): Start the burn-in mode on the DALI ballasts, all DALI ballasts in the group or all DALI ballasts on the channel, which is associated with this Multi-State Output object. Some lamps require a burn-in time during which they must not be dimmed. The burn-in time is defined by the corresponding configuration property – e.g. *nciBurnInTime* (LONMARK) or *Burn_In_Time* (BACnet) – of the corresponding channel fieldbus object. During this time the lamps will only be switched to on (100%) or off (0%) but not dimmed. For more information on the burn-in functionality see Section 6.2.2.8.

STOP BURN IN (51): Abort burn-in mode.

RESET RUN HOURS (52): Reset the run hours of the the DALI ballasts, all DALI ballasts in the group or all DALI ballasts on the channel, which is associated with this Multi-State Output object. For more information on the run hours monitoring functionality see Section 6.2.2.7.

RESET ENERGY COUNT (53): Reset the energy counter of the DALI ballasts, all DALI ballasts in the group or all DALI ballasts on the channel, which is associated with this Multi-State Output object. For more information on the energy monitoring functionality see Section 6.2.2.7.

START EMERGENCY FUNCTION TEST (54): Start function test of self-contained emergency lights supporting this function. Depending on the associated Multi-State Output object the function test is started on the DALI self-contained emergency light, all DALI self-contained emergency lights in the group or all DALI self-contained emergency lights on the channel. Please refer to the documentation of the ballast vendor to determine whether a ballast supports execution of a function test. For more information on testing of emergency lights see Section 6.2.2.5.

START EMERGENCY DURATION TEST (55): Start duration test of self-contained emergency lights supporting this function. Depending on the associated Multi-State Output object the duration test is started on the DALI self-contained emergency light, all DALI self-contained emergency lights in the group or all DALI self-contained emergency lights on the channel. Please refer to the documentation of the ballast vendor to determine whether the ballast supports execution of a duration test. For more information on testing of emergency lights see Section 6.2.2.5.

STOP EMERGENCY TESTS (56): Abort any function and duration test currently executed or pending.

UP (57): Ramp up (fade with constant rate) until command STOP is issued or 100% is reached. Do not switch on if lights are off. Affects DALI device, DALI group address or DALI broadcast address, which is associated with this Multi-State Output object.

ON AND UP (58): Ramp up (fade with constant rate) until command STOP is issued or 100% is reached. Switch on if lights are off. Affects DALI device, DALI group address or DALI broadcast address, which is associated with this Multi-State Output object.

DOWN (59): Ramp down (fade with constant rate) until command STOP is issued or minimum dim level is reached. Affects DALI device, DALI group address or DALI broadcast address, which is associated with this Multi-State Output object.

DOWN AND OFF (60): Ramp down (fade with constant rate) until command STOP is issued or 0% dim level is reached. Affects DALI device, DALI group address or DALI broadcast address, which is associated with this Multi-State Output object.

STOP (61): Stop any dim process.

COLOUR WARMER (62): Ramp down¹ (with constant rate) colour temperature until command STOP is issued or minimum colour temperature is reached. Affects DALI ballast, DALI group address or DALI broadcast address, which is associated with this Multi-State Output object. Only affects DALI ballasts supporting Tc colour control as specified by IEC 62386-209. For more information on colour control see Section 6.2.2.10.

COLOUR COOLER (63): Ramp up² (with constant rate) colour temperature until command STOP is issued or maximum colour temperature is reached. Affects DALI ballast, DALI group address or DALI broadcast address, which is associated with this Multi-State Output object. Only affects DALI ballasts supporting Tc colour control as specified by IEC 62386-209. For more information on colour control see Section 6.2.2.10.

Status_Flags (Read-Only)

Of the four flags the flags IN_ALARM, FAULT, and OUT_OF_SERVICE are linked to the state of the corresponding properties *Event_State*, *Reliability* and *Out_Of_Service* as described by the standard.

OVERRIDDEN Always FALSE.

Reliability (Read-Only)

The *Reliability* property of this object type may have any of the following values:

NO_FAULT_DETECTED No fault was detected.

Number_Of_States (Read-Only)

This property has the value 63.

State_Text (Read/Write)

Per default this property contains the strings defined for the states in the description of the *Present_Value* property (e.g. NO_COMMAND, RECALL SCENE XX, etc.).

Profile_Name (Read-only)

This property has the following values:

- DALI ballasts: “178-http://www.loytec.com/xsd/DALILampCommand/v1”
- DALI groups: “178-http://www.loytec.com/xsd/DALIGroupCommand/v1”
- DALI channels: “178-http://www.loytec.com/xsd/DALICHannelCommand/v1”

¹ A lower colour temperature value (in degree Kelvin) is considered a warmer colour.

² A higher colour temperature value (in degree Kelvin) is considered a cooler colour.

6.2.2.17 Analog Input Object – Battery Status of DALI emergency ballast, group, or channel

This object is used to report the current battery charge status of self-contained emergency lights (see Table 14). For more information on emergency lighting functionality see Section 6.2.2.5).

Property Identifier	Property ID	Property Datatype	Conformance Code	Data Point
Object_Identifier	75	BACnetObjectIdentifier	R	
Object_Name	77	CharacterString	R	✓
Object_Type	79	BACnetObjectType	R	
Present_Value	85	REAL	R	✓
Device_Type	31	CharacterString	R	
Status_Flags	111	BACnetStatusFlags	R	
Event_State	36	BACnetEventState	R	
Reliability	103	BACnetReliability	R	
Out_Of_Service	81	BOOLEAN	W	
Units	117	BACnetEngineeringUnits	R	
Min_Pres_Value	69	REAL	R	
Max_Pres_Value	65	REAL	R	
COV_Increment	22	REAL	W	
Profile_Name	168	CharacterString	R	

Table 20: Properties of the Analog Input object providing battery status from self-contained emergency lights.

Object_Identifier (Read-Only)

The default instance number is ABCC, where “A” is 6 for the objects associated with DALI devices and 7 for the objects associated with DALI groups, and 8 with DALI channels, “B” is the DALI interface number (0-3) in decimal, and “CC” is the DALI device number (00-63) or the DALI group address (00-15) respectively in decimal (00 for DALI channels). Examples: Group 5 on channel 1 has the instance number 7005, and channel 4 has the instance number 8300.

Object_Name (Read-Only)

This property holds the value of the *Object_Name* of the associated Analog Output object with the addition “*Battery_Charge*”.

Object_Type (Read-Only)

The value of this property is ANALOG_INPUT (0).

Present_Value (Read-Only)

This property, of type REAL, indicates the battery charge status (0..100.00%) of a self-contained DALI emergency light. For objects associated to groups or channels this property reports the minimum value of all self-contained emergency lights in the group or channel, respectively.

Device_Type (Read-Only)

This property contains the value “*Battery_Charge*”.

Status_Flags (Read-Only)

Of the four flags the flags IN_ALARM, FAULT, and OUT_OF_SERVICE are linked to the state of the corresponding properties *Event_State*, *Reliability* and *Out_Of_Service* as described by the standard.

OVERRIDDEN Always FALSE.

Reliability (Read-Only)

The *Reliability* property for this object type may have any of the following values:

NO_FAULT_DETECTED	No fault was detected.
NO_SENSOR	Battery charge status unknown or not supported (for objects associated with groups or channels if all ballasts in group/channel do not report battery charge).
COMMUNICATION_FAILURE	Ballast offline (for groups and channels if at least one ballast is offline in the group/on the channel).
UNRELIABLE_OTHER	Other failure detected (e.g. DALI device type specific error, for groups and channels if at least one ballast in the group/on the channel reports a failure)

Units (Read-Only)

The value of this property is 98 (percent).

Min_Pres_Value (Read-Only)

The value of this property is 0.

Max_Pres_Value (Read-Only)

The value of this property is 100.

Profile_Name (Read-only)

This property has the following values:

- DALI lamps: “178-<http://www.loytec.com/xsd/DALILampBatteryCharge/v1>”
- DALI groups: “178-<http://www.loytec.com/xsd/DALIGroupBatteryCharge/v1>”
- DALI channels: “178-<http://www.loytec.com/xsd/DALICHannelBatteryCharge/v1>”

6.2.3 Sensor Objects

The L-DALI provides objects for 16 DALI sensors per channel. Each sensor is represented by

- an Analog Input object providing the lux level measured by the sensor and
- an Binary Input object providing the occupancy state determined by the sensor.

6.2.3.1 Sensor Calibration

To provide a reliable measurement the light sensor needs to be calibrated. The calibration is best performed with the LINX Configurator software (see LINX Configurator User Manual [2]) or using the Web Interface (see LOYTEC Device User Manual [1]).

6.2.3.2 Analog Input Object – DALI lux level sensor

This object is used to represent the light sensor part of a DALI Sensor (see Table 21). There is a maximum of 16 such objects per channel.

Property Identifier	Property ID	Property Datatype	Conformance Code	Data Point
Object_Identifier	75	BACnetObjectIdentifier	R	
Object_Name	77	CharacterString	R	✓
Object_Type	79	BACnetObjectType	R	
Present_Value	85	REAL	R	✓
Device_Type	31	CharacterString	R	✓
Status_Flags	111	BACnetStatusFlags	R	
Event_State	36	BACnetEventState	R	
Reliability	103	BACnetReliability	R	✓
Out_Of_Service	81	BOOLEAN	W	
Units	117	BACnetEngineeringUnits	R	
Min_Pres_Value	69	REAL	R	
Max_Pres_Value	65	REAL	R	✓
COV_Increment	22	REAL	W	
Time_Delay	113	Unsigned	W	
Notification_Class	17	Unsigned	W	
High_Limit	45	REAL	W	
Low_Limit	59	REAL	W	
Deadband	25	REAL	W	
Limit_Enable	52	BACnetLimitEnable	W	
Event_Enable	35	BACnetEventTransitionBits	W	
Acked_Transitions	0	BACnetEventTransitionBits	W	
Notify_Type	72	BACnetNotifyType	W	
Event_Time_Stamps	130	BACnetARRAY[3] of BACnetTimeStamp	R	
Profile_Name	168	CharacterString	R	
Lux_2	557	REAL	R	✓

Table 21: Properties of the Analog Input object representing a DALI lux level sensor.

Object_Identifier (Read-Only)

The default instance number is 5BCC, where “B” is the DALI interface number (0-3) in decimal, and “CC” is the DALI device number (00-15). Example: DALI sensor 4 on channel 2 has the instance number 5104.

Object_Name (Read/Write)

This property holds the name of the DALI sensor. It can be changed via the Web-UI.

Object_Type (Read-Only)

The value of this property is ANALOG_INPUT (0).

Present_Value (Read-Only)

This property reports the current light level reported by the sensor corrected by the calibration function configured via the gain table (see Section 6.2.3.1).

Device_Type (Read-Only)

This property contains the type of DALI sensor (e.g. “Tridonic Sensor”).

Status_Flags (Read-Only)

Of the four flags the flags IN_ALARM, FAULT, and OUT_OF_SERVICE are linked to the state of the corresponding properties *Event_State*, *Reliability* and *Out_Of_Service* as described by the standard.

OVERRIDDEN Always FALSE.

Reliability (Read-Only)

The *Reliability* property for this object type may have any of the following values:

NO_FAULT_DETECTED No fault was detected.

NO_SENSOR No sensor assigned or some failure reported by the DALI sensor (no light value reported).

COMMUNICATION_FAILURE Sensor offline.

UNRELIABLE_OTHER Other failure detected.

Units (Read-Only)

The value of this property is 37 (lux).

Min_Pres_Value (Read-Only)

The value of this property is 0.

Max_Pres_Value (Read-Only)

The value of this property is “Infinity”.

Profile_Name (Read-only)

The value of this property is “178-<http://www.loytec.com/xsd/DALILightSensor/v1>”.

Lux_2 (Read-only)

If the assigned sensor provides multiple lux level sensor values this property (property ID 557) reports the current second light level value reported by the sensor. No gain table correction is applied.

Intrinsic reporting

The object supports all properties required for intrinsic reporting. Per default only fault alarms are enabled.

6.2.3.3 Binary Input Object – DALI occupancy sensor

This object is used to represent the occupancy sensor part of a DALI Sensor (see Table 22). There is a maximum of 16 such objects per channel.

Property Identifier	Property ID	Property Datatype	Conformance Code	Data Point
Object_Identifier	75	BACnetObjectIdentifier	R	
Object_Name	77	CharacterString	R	✓
Object_Type	79	BACnetObjectType	R	
Present_Value	85	BACnetBinaryPV	R	✓
Status_Flags	111	BACnetStatusFlags	R	
Event_State	36	BACnetEventState	R	
Reliability	103	BACnetReliability	R	✓
Out_Of_Service	81	BOOLEAN	W	
Polarity	84	BACnetPolarity	W	
Inactive_Text	46	CharacterString	W	
Active_Text	4	CharacterString	W	
Profile_Name	168	CharacterString	R	
Debounce	535	Unsigned	W	✓
Unoccupied_Delay	536	Unsigned	W	✓
Heartbeat	558	Unsigned	W	✓

Table 22: Properties of the Binary Input object representing a DALI occupancy sensor.

Object_Identifier (Read-Only)

The instance number is equal to the instance number of the corresponding Analog Input object (see Section 6.2.3.2).

Object_Name (Read-Only)

This property holds the value of the *Object_Name* of the associated Analog Input object with the addition “Occupancy”.

Object_Type (Read-Only)

The value of this property is BINARY_INPUT (3).

Present_Value (Read-Only)

This property reports the occupancy status. If the *Polarity* property is *NORMAL* the occupied state corresponds to *ACTIVE*, while the unoccupied state corresponds to *INACTIVE*.

Status_Flags (Read-Only)

Of the four flags the flags IN_ALARM, FAULT, and OUT_OF_SERVICE are linked to the state of the corresponding properties *Event_State*, *Reliability* and *Out_Of_Service* as described by the standard.

OVERRIDDEN Always FALSE.

Reliability (Read-Only)

The *Reliability* property for this object type may have any of the following values:

NO_FAULT_DETECTED	No fault was detected.
NO_SENSOR	No sensor assigned or some failure reported by the DALI sensor (no occupancy value reported).
COMMUNICATION_FAILURE	Sensor offline.
UNRELIABLE_OTHER	Other failure detected.

Profile_Name (Read-only)

The value of this property is “178-http://www.loytec.com/xsd/DALIOccupancy_Sensor/v1”.

Debounce (Read/Write)

The value of this proprietary property (property ID 535) specifies the debouncing time in seconds (see Section 6.1.3.1).

Unoccupied_Delay (Read/Write)

The value of this proprietary property (property ID 536) determines the delay in seconds after which the state changes to unoccupied. The timer is armed each time the value reported by the sensor changes from occupied to unoccupied. A value of 0 disables the unoccupied delay.

Heartbeat (Read/Write)

The value of this proprietary property (property ID 558) determines the maximum period of time that expires before the object automatically updates its *Present_Value*. This allows using the *Present_Value* as occupancy event input to a constant light controller object.

6.2.4 Constant Light Controller

The L-DALI provides 16 constant light controller instances with built in occupancy controller functionality for each DALI channel. Every instance is represented by a BACnet Loop object.

6.2.4.1 Interaction with other BACnet Objects

When using local DALI sensors and/or DALI groups internal manual CLC bindings can be configured in the DALI Parameters tab of the LINX Configurator software (see LINX Configurator User Manual [2]) or the Web-Interface (see Section 6.3.1). The Web-Interface for CLC Bindings can also be used to verify the current status of all bindings (internal and NVs).

Alternatively, the Loop Object allows automatically retrieving its input values from and writing its output values to other BACnet server objects. To reference the property and server object it provides properties of type *BACnetObjectPropertyReference*. Specifically these are:

- *Manipulated_Variable_Reference*: Writing *Present_Value* (Constant Light Controller output, e.g. to Analog Output controlling DALI lights, see Section 6.2.2.11).
- *Controlled_Variable_Reference*: Reading lux level input (e.g. from DALI lux level sensor, see Section 6.2.3.2).

- *Setpoint_Reference*: Reading setpoint value.
- *Occupancy_Variable_Reference* (property ID 537): Reading occupancy input (e.g. from DALI occupancy sensor, see Section 6.2.3.3).

Note, that the referenced server object must be local.

6.2.4.2 Setpoint

The desired setpoint for the illumination level is configured via the property *Setpoint*.

6.2.4.3 Operating Modes

The operating mode of the constant light controller is set via the proprietary property *Mode* (property ID 539). Table 23 shows the different operating modes and under which conditions they are used:

Operating Mode	Description
REGULATOR (1)	A light sensor that measures the indoor illumination is installed. An occupancy sensor is installed.
CONTROL (2)	A light sensor that measures the outdoor illumination is installed. An occupancy sensor is installed.
UPDATER (3)	A DALI sensor with constant light controller functionality shall be mapped to the BACnet network. Only the setpoint shall be adjustable via the BACnet interface.
PRESENCE (4)	Based on occupancy the lights shall be switched on and off.
REGULATOR_NO_OCC (5)	A light sensor that measures the indoor illumination is installed. No occupancy sensor is installed.
CONTROL_NO_OCC (6)	A light sensor that measures the outdoor illumination is installed. No occupancy sensor is installed.
MANUAL_ON_AUTO_OFF (7)	Lights are switched on manually, but shall be switched off based on occupancy.
REGULATOR_AUTO (8)	Similar to REGULATOR, but a manual override is automatically relinquished when the room becomes unoccupied.
CONTROL_AUTO (9)	Similar to CONTROL, but a manual override is automatically relinquished when the room becomes unoccupied.
PRESENCE_AUTO (10)	Similar to PRESENCE, but a manual override is automatically relinquished when the room becomes unoccupied.
AMBIENT (11)	Effect or ambient lighting is switched on based on the measured illumination level (switching on ambient lights does not influence measured illumination level).
REGULATOR_BEDROOM (12)	Similar to REGULATOR_AUTO, but a manual override is not automatically relinquished when the lights are overridden to off.
CONTROL_BEDROOM (13)	Similar to CONTROL_AUTO, but a manual override is not automatically relinquished when the lights are overridden to off.
REGULATOR_MANUAL (14)	Similar to REGULATOR, but the automatic mode must be manually activated (e.g. via a button, not triggered by occupancy). Lights are switched off and automatic mode is disabled when turning unoccupied.
CONTROL_MANUAL (15)	Similar to CONTROL, but the automatic mode must be manually activated (e.g. via a button, not triggered by occupancy). Lights are switched off and automatic mode is disabled when turning unoccupied.
REGULATOR_MANUAL_LUX (16)	Similar to REGULATOR_MANUAL, but the automatic mode is disabled, whenever lights are switched off, either due to becoming unoccupied or due to enough natural light being available.
CONTROL_MANUAL_LUX (17)	Similar to CONTROL_MANUAL, but the automatic mode is disabled, whenever lights are switched off, either due to becoming unoccupied or due to enough natural light being available.
REGULATOR_NO_MANUAL	Similar to REGULATOR, but ignoring overrides via buttons or other DALI masters (see Section 6.2.4.10).
CONTROL_NO_MANUAL	Similar to CONTROL, but ignoring overrides via buttons or other DALI masters (see Section 6.2.4.10).

Operating Mode	Description
PRESENCE_NO_MANUAL	Similar to PRESENCE, but ignoring overrides via buttons or other DALI masters (see Section 6.2.4.10).

Table 23: Constant Light Controller Operation Modes

Regulator Mode

The REGULATOR mode has to be selected if the installed light sensor measures the indoor brightness. The constant light controller receives the current indoor lux level via the property *Controlled_Variable_Value* and adjusts the lamp level (from 0% to 100%) by means of a fuzzy control algorithm.

When the light is switched on the control algorithm selects a lamp value which results in a lux level close to the desired setpoint and then adjusts the lamp value in increments once every second until the configured setpoint is reached. The size of increments is adjusted dynamically but will never exceed the percentage value defined in the proprietary property *Step_Value* (property ID 544).

The regulator mode is available in different flavors:

- **With our without occupancy sensor:** If an occupancy sensor is installed and the room becomes unoccupied, the current light level is saved and the light is dimmed to unoccupied level (see Section 6.2.4.8). If the room becomes occupied before the light has reached the unoccupied level, the saved light level is restored.
- **With automatic relinquish:** A manual override will be automatically relinquished when the room becomes unoccupied. In a special bedroom mode the automatic relinquish will only take place if the lights are on. If they were switched off manually, the controller does not return to automatic mode when the area turns unoccupied.
- **With manual activation:** In this flavor, the automatic lighting control must be manually activated (e.g. via a button) and lights will not be switched on automatically when the room becomes occupied. To give the user some visual feedback lights will be switched on, even if the light level in the room is above the setpoint, whenever the automatic mode is activated (either via a data point or via a DALI button). When the room becomes unoccupied the automatic mode is deactivated. In the REGULATOR_MANUAL_LUX flavor, the automatic mode is deactivated whenever lights are switched off (e.g. due to the natural light being above the setpoint).

Control Mode

The CONTROL mode has to be selected if the installed light sensor measures the outdoor illumination. The constant light controller receives the current outdoor lux level via the property *Controlled_Variable_Value* and sets the lamp level (from 0% to 100%) accordingly (see Figure 75).

The proprietary property *Step_Value* (property ID 544) ensures that the light level does not change abruptly. Per second the light level is not changed more than the percentage value defined by this configuration property. When the light is switched on or off, *Step_Value* is not taken into account.

To ensure that the setpoint is reached under all weather conditions, the control curve shown Figure 75 has to be adjusted by calibrating the constant light controller.

The control mode is available in different flavors:

- **With our without occupancy sensor:** If an occupancy sensor is installed and the room becomes unoccupied, the current light level is saved and the light is dimmed to

unoccupied level (see Section 6.2.4.8). If the room becomes occupied before the light has reached the unoccupied level, the saved light level is restored.

- **With automatic relinquish:** A manual override will be automatically relinquished when the room becomes unoccupied. In a special bedroom mode the automatic relinquish will only take place if the lights are on. If they were switched off manually, the controller does not return to automatic mode when the area turns unoccupied.
- **With manual activation:** In this flavor, the automatic lighting control must be manually activated (e.g. via a button) and lights will not be switched on automatically when the room becomes occupied. To give the user some visual feedback lights will be switched on, even if the light level in the room is above the setpoint, whenever the automatic mode is activated (either via a data point or via a DALI button). When the room becomes unoccupied the automatic mode is deactivated. In the CONTROL_MANUAL_LUX flavor, the automatic mode is deactivated whenever lights are switched off (e.g. due to the natural light being above the setpoint).

Presence Mode

The PRESENCE mode has to be if the constant light controller shall operate as occupancy controller. In this mode the light is switched to the value specified in the proprietary property *Occupied_Level* (property ID 542) if the room is occupied and to the unoccupied level (see Section 6.2.4.8) if the room is unoccupied.

The light is switched to the value *Occupied_Level* only if the lux level is below *Setpoint* and the room is occupied.

The presence mode is available in different flavors:

- **With or without automatic relinquish:** If automatic relinquish is active a manual override will be automatically relinquished when the room becomes unoccupied.

Manual-On/Auto-Off Mode

The MANUAL_ON_AUTO_OFF mode is a variation of the PRESENCE mode. However, in this mode the constant light controller does not switch on the lights, when the room becomes occupied. Rather, it switches the lights to the unoccupied level (see Section 6.2.4.8) when the room becomes unoccupied, using the property *Hold_Time* similar to PRESENCE mode.

Lights can be switched on (or off) via some other DALI master (e.g. a DALI push-button).

Ambient Mode

The AMBIENT mode is used if effect lighting (e.g. lights in a shop window, facade lighting, floor lights etc.) has to be switched on or off depending on a measured light level. Lights are switched to the value specified in the proprietary property *Occupied_Level* (property ID 542) when the lux level is below *Setpoint* and to the unoccupied level (see Section 6.2.4.8) when lux level is higher than *Setpoint*.

Updater Mode

The UPDATER mode has to be selected when a DALI light/occupancy sensor with constant light controller functionality is installed on the DALI network. In this mode no light level computation is performed. The controller simply forwards the parameters to the DALI constant light controller and retrieves lamp setting from the DALI light sensor.

In general, LOYTEC does not recommend using UPDATER mode. Wherever possible use REGULATOR or CONTROL mode instead and use DALI sensors only as lux level and

occupancy information source via the corresponding sensor objects. These modes allow improved influence of the constant light controller's parameters via the fieldbus side.

6.2.4.4 Prioritized Control

Manual override of the constant light controller can be accomplished in multiple ways:

- Using the priority array of the controlled lamp actuator Analog Output object using a higher priority than the constant light controller.
- Using the *Override* property of the constant light controller Loop object.
- Using a DALI push-button device on groups linked to the constant light controller (see Section 6.2.4.10).
- With a scene recall on groups linked to the constant light controller (see Section 6.2.2.1).

To return to automatic mode the following options exist:

- Set the value of the *Override* property to -1 or invalid.
- Using the button function AUTO of a DALI push-button (e.g. LDALI-BM1) with the destination set to one of the constant light controllers groups (see Section 6.2.4.10).
- Recalling the scene "AUTOMATIC MODE" on the scene controller object of a group linked to the constant light controller (see Section 6.2.2.1).
- When using one of the modes with automatic override relinquish (xxx_AUTO or xxx_BEDROOM) the constant light controller will return to automatic mode when it changes its state to unoccupied.

Whether the constant light controller is in automatic mode or in manual/override mode is reflected by the property *Auto_Mode*.

6.2.4.5 Controlling Multiple Light Bands

The L-DALI constant light controller allows controlling two light bands (groups). The primary light band (Light Band 1) is near the inside of the building, the secondary light band (Light Band 2) is near the window front. Depending on the outdoor light intensity the primary light band has to be brighter than the secondary light band to illuminate the room evenly.

The primary light band is controlled by the *Present_Value* property of the Loop object. Further for both light bands internal bindings to local DALI groups and their corresponding Analog Output objects can be done (see Section 6.3.1).

The maximum difference between the two light bands can be configured via the configuration property *Lamp_2_Offset* as shown in Figure 89. The configuration property *Lamp_2_Limit* defines the light level above which the output values of light band 1 and 2 are identical.

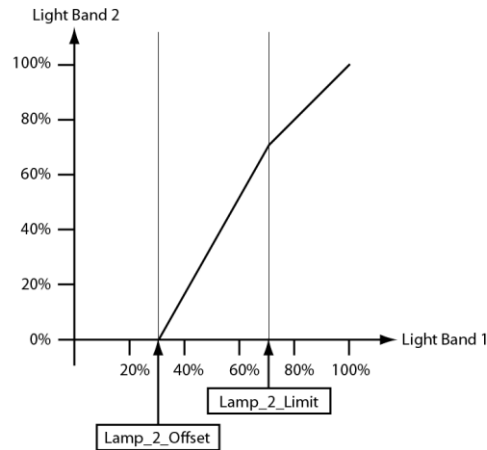

Figure 89: Secondary Light Band

6.2.4.6 Occupancy Detection

The constant light controller receives the occupancy information via the proprietary property *Occupancy_Variable_Value* (property ID 538). How this information is evaluated depends on the hold time configured in the proprietary property *Hold_Time* (property ID 540).

If a hold time is configured ($Hold_Time > 0$) occupancy evaluation is event based. That is, the constant light controller changes to the occupied state when the value OCCUPIED (1) is received. When the UNOCCUPIED (2) value is received the constant light controller remains in the occupied state until the hold time configured in *Hold_Time* has expired and then changes to the unoccupied state. Further, if no OCCUPIED is received for the time configured in *Hold_Time* the constant light controller changes to the unoccupied state, too.

This behavior typically requires the occupancy sensor to send OCCUPIED with a regular interval (heartbeat). It allows using multiple occupancy sensors with the same constant light controller (fan-in). It is the recommended mode if the occupancy information is received via the local DALI occupancy objects (see Section 6.2.3.3).

If no hold time is configured ($Hold_Time = 0$) occupancy evaluation is state based. That is, the constant light controller changes to the occupied state when the value OCCUPIED is received and to unoccupied state when the value UNOCCUPIED is received.

This behavior is typically required if the occupancy information is only propagated if the state changes (no heartbeat functionality). It does not allow using multiple occupancy (fan-in) sensors without additional logic (e.g. an Occupancy Controller). It is the recommended mode, when using occupancy information from other BACnet devices.

After the light has been switched off any updates on the *Occupancy_Variable_Value* input are ignored for the time specified in *Ignore_Time* (property ID 541).

The current occupancy state calculated by the constant light controller is available via the property *Occupancy_State* (property ID 562).

6.2.4.7 Timing Parameters

To avoid that the constant light controller switches the light on and off repeatedly if the measured lux value is near the setpoint, a hysteresis can be configured. The proprietary property *Off_Hysteresis* (property ID 546) defines the hysteresis for switching off the lamp and the proprietary property *On_Hysteresis* (property ID 545) defines the hysteresis for

switching on the lamp. In addition a delay can be configured before the lamp is switched on (*On_Delay*) or off (*Off_Delay*). Figure 90 illustrates these configuration parameters.

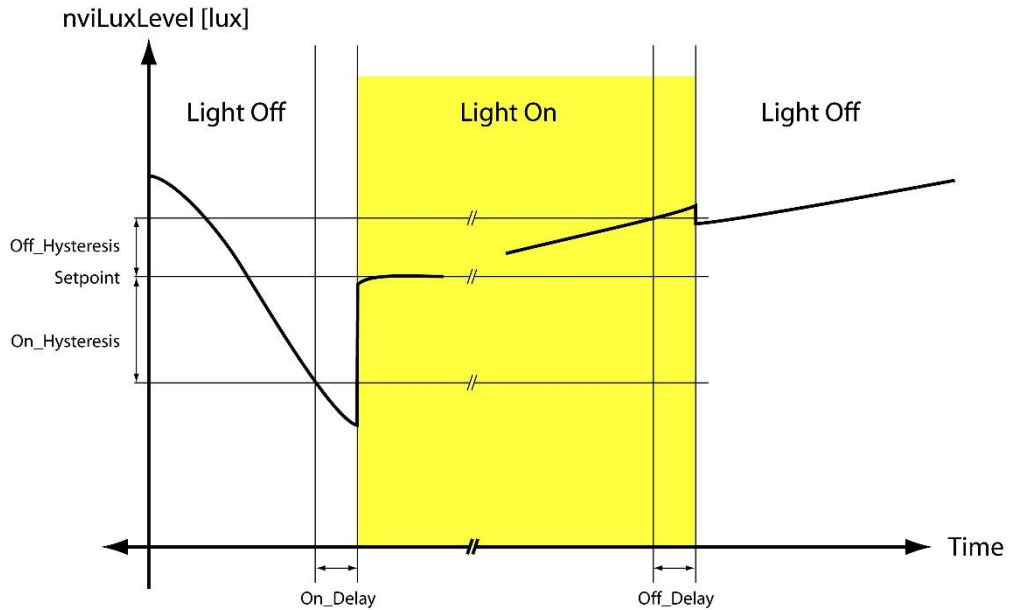

Figure 90: Constant Light Controller Timing.

6.2.4.8 Unoccupied Level

If the constant light controller enters unoccupied state (see Section 6.2.4.6) *Unoccupied_Level* (property ID 543) and *Off_Delay* (property ID 547) determine the behavior as shown in Table 24.

<i>Unoccupied_Level</i>	<i>Off_Delay</i>	Behavior
0	0	Dim down and switch off lights
> 0	0	Dim down lights to value defined in <i>Unoccupied_Level</i> .
0	> 0	Dim down to 0.5% and switch off lights after <i>Off_Delay</i> .
> 0	> 0	Dim down lights to value defined in <i>Unoccupied_Level</i> and switch off lights after <i>Off_Delay</i> .

Table 24: Behavior of constant light controller when entering unoccupied state.

6.2.4.9 Neighboring Controllers

In open office space applications, typically the different zones of the space are controlled by independent constant light controller instances. This ensures, that only the zones, which are still occupied are lit. To reduce the contrast between lit and unlit zones in case only a single zone is occupied amidst many unoccupied zones and to increase user comfort in such a scenario, unoccupied zones adjacent to occupied zones shall be lit up at a configurable low light level (*Unoccupied_Level*, property ID 543).

For this purpose each controller needs to know its neighboring controllers. A controller notifies the CLCs configured as neighbors whenever it switches its lights on. Now, the neighboring controllers, which are unoccupied, can switch to *Unoccupied_Level*. Once the CLC switches lights off (e.g. because it becomes unoccupied) it again notifies the configured neighbors, which in turn can switch off as well.

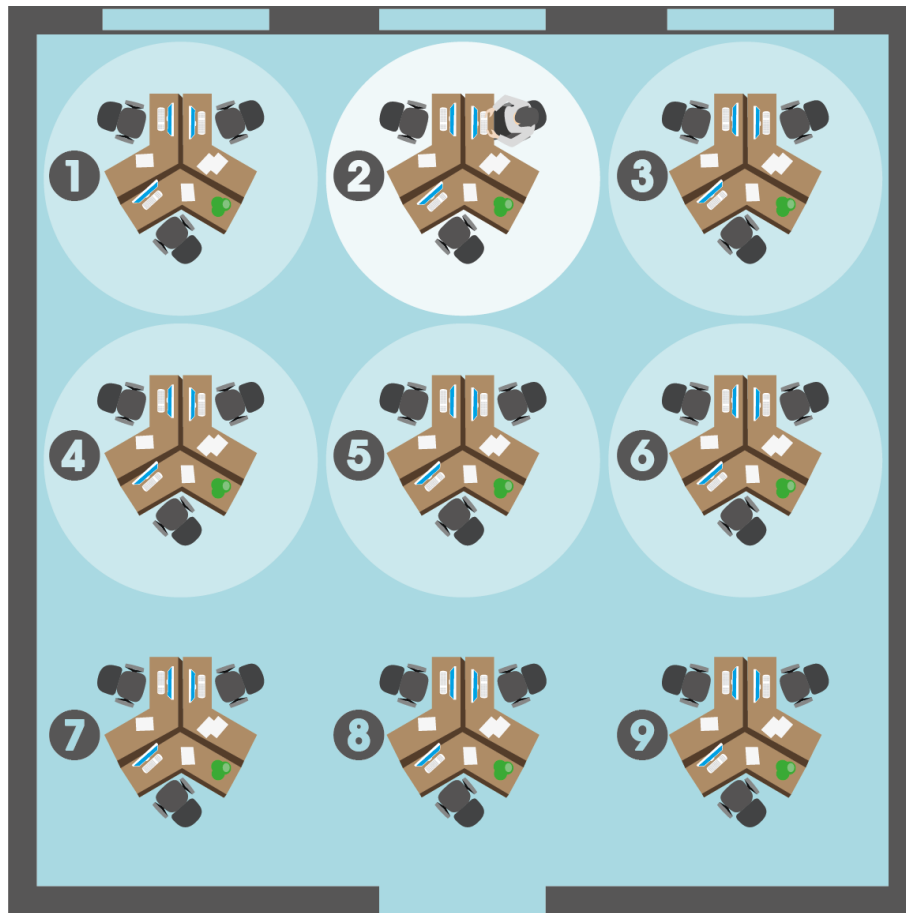

Figure 91: Different zones of an open office space.

Figure 91 shows an example of an open office space with nine zones controlled by independent constant light controller instances. In this example only zone 2 is occupied and fully lit. Zones 1 and 3 to 6 are configured as neighbors of zone 1 and therefore lit at a low dim level, while the remaining zones are switched off.

For each CLC instance up to 16 neighbors can be configured. The neighboring controllers can be configured either via the CLC Bindings page in the web UI (see Section 6.3.1) or via the DALI parameters tab in the LINX Configurator (see LINX Configurator User Manual [2])

6.2.4.10 Interaction with Buttons Functions

When internal CLC bindings are used to control DALI groups an override can also be performed using a button function (see Section 6.3.3) or some other DALI master (like push-buttons etc.) controlling the same groups as the constant light controller.

Whenever the light level of one of the ballasts controlled by the constant light controller is changed by operating a button the constant light controller will detect this and stop controlling the group and enter override mode. Furthermore, the *Present_Value* of the Constant Light Controllers Loop Object will be updated with the new feedback value of the group controlled by the button.

To disable the manual override via buttons and other DALI masters select the constant light controller operating mode `REGULATOR_NO_MANUAL`, `CONTROLLER_NO_MANUAL` or `PRESENCE_NO_MANUAL`, respectively. In this case the constant light controller application will continue control the group and enforce its output value.

See Section 6.3.3 on how to configure DALI button functions via the web interface and the LINX Configurator User Manual [2] how to configure them via the DALI Parameters tab of the LINX Configurator software.

6.2.4.11 Interacting with Sunblind Controller

One or more local sunblind controller objects can be linked to a constant light controller object. Typically sunblind controllers are linked to the constant light controller of the same room. If they change the sunblind's position or rotation the sunblind controllers inform the linked constant light controller. The constant light controller uses this information to "ignore" temporary changes of the rooms illumination levels due to the moving sunblinds and, thus, can avoid to switch on lights unnecessarily.

6.2.4.12 Museum Mode

The museum mode is activated by setting an upper limit for the lux level in the room using the proprietary property *Lux_Upper_Limit* (property ID 566). In museum mode the constant light controller cooperates with the linked sunblind controllers to ensure that the measured lux level stays between *Setpoint* and *Lux_Upper_Limit*. Therefore at least one sunblind controller has to be linked to the constant light controller.

If the light intensity in the room needs to be increased to reach the lower setpoint (*Setpoint*) there are two possibilities: Increase the lamp level or open the sunblinds. The proprietary property *Sblnd_Hyst* (property ID 568) defines how much the lamp level is increased or decreased before opening or closing the sunblinds respectively.

6.2.4.13 Loop Object – Constant Light Controller application

This object is used to represent a constant light controller instance (see Table 25). There are up to 16 instances per DALI channel available.

Property Identifier	Property ID	Property Datatype	Conformance Code	Data Point
Object_Identifier	75	BACnetObjectIdentifier	R	
Object_Name	77	CharacterString	R	✓
Object_Type	79	BACnetObjectType	R	
Present_Value	85	REAL	R	✓
Description	28	CharacterString	W	
Status_Flags	111	BACnetStatusFlags	R	
Event_State	36	BACnetEventState	R	✓
Reliability	103	BACnetReliability	R	✓
Out_Of_Service	81	BOOLEAN	W	
Output_Units	82	BACnetEngineeringUnits	R	
Manipulated_Variable_Reference	60	BACnetObjectPropertyReference	W	
Controlled_Variable_Reference	19	BACnetObjectPropertyReference	W	
Controlled_Variable_Value	21	REAL	W	✓
Controlled_Variable_Units	20	BACnetEngineeringUnits	R	
Setpoint_Reference	109	BACnetSetpointReference	W	
Setpoint	108	REAL	W	✓
Action	2	BACnetAction	R	
Priority_For_Writing	88	Unsigned	W	
COV_Increment	22	REAL	W	
Profile_Name	168	CharacterString	R	
Occupancy_Variable_Reference	537	BACnetObjectPropertyReference	W	
Occupancy_Variable_Value	538	BOOLEAN	W	✓
Mode	539	Unsigned	W	✓
Hold_Time	540	Unsigned	W	✓
Ignore_Time	541	Unsigned	W	✓
Occupied_Level	542	REAL	W	✓
Unoccupied_Level	543	REAL	W	✓
Step_Value	544	REAL	W	✓
On_Hysteresis	545	REAL	W	✓
Off_Hysteresis	546	REAL	W	✓
Off_Delay	547	Unsigned	W	✓
On_Delay	548	Unsigned	W	✓
Lamp_2_Offset	550	REAL	W	✓
Lamp_2_Limit	551	REAL	W	✓
Override	560	REAL	W	✓
Auto_Mode	561	BACnetBinaryPV	R	✓
Occupancy_State	562	BACnetBinaryPV	R	✓
Lux_Upper_Limit	566	REAL	W	✓
Sblnd_Hyst	568	REAL	W	✓

Table 25: Properties of the Loop object representing a Constant Light Controller Application.

Object_Identifier (Read-Only)

The default instance number is BCC, where “B” is the DALI interface number (0-3) in decimal, and “CC” is the Constant Light Controller instance on the channel (00-15).

Object_Name (Read-Only)

This property holds the name of the constant light controller.

Object_Type (Read-Only)

The value of this property is LOOP (12).

Present_Value (Read-Only)

This property, of type REAL, indicates the linearized percentage (0..100.00%) of the constant light controller output.

Description (Read/Write)

This property can be configured via BACnet. It serves documentation purposes only.

Reliability (Read-Only)

The *Reliability* property for this object type may have any of the following values:

NO_FAULT_DETECTED	No fault was detected.
OPEN_LOOP	The sensor value does not change when the output is controlled (CONTROL mode only).
COMMUNICATION_FAILURE	Communication with sensor or light output not working.
UNRELIABLE_OTHER	Other failure detected.

Output_Units (Read-Only)

The value of this property is 98 (percent).

Manipulated_Variable_Reference (Read/Write)

Specifies the object and property the value of the *Present_Value* property is written to.

Controlled_Variable_Reference (Read/Write)

Specifies the object and property the light sensor value is read from.

Controlled_Variable_Value (Read/Write)

This property holds the current light sensor value as read from *Controlled_Variable_Reference*.

Controlled_Variable_Units (Read-Only)

The value of this property is 37 (lux).

Setpoint_Reference (Read/Write)

Specifies the object and property the setpoint for the constant light controller algorithm is read from.

Setpoint (Read/Write)

This property holds the setpoint for the constant light controller algorithm.

Action (Read-Only)

The value of this property is DIRECT.

Profile_Name (Read-only)

The value of this property is “178-http://www.loytec.com/xsd/ConstantLightController/v1”.

Occupancy_Variable_Reference (Read/Write)

This proprietary property (property ID 537) specifies the object and property the occupancy sensor value is read from.

Occupancy_Variable_Value (Read/Write)

This proprietary property (property ID 538) holds the current occupancy sensor value as read from Occupancy_Variable_Reference.

Mode (Read/Write)

This proprietary property (property ID 539) holds the constant light controller operating mode (see Section 6.2.4.3).

Hold_Time (Read/Write)

This proprietary property (property ID 540) holds the hold time for the occupancy state in seconds. When the OCCUPIED (1) value is received via *Occupancy_Variable_Value* the constant light controller remains in the occupied state until the hold time has expired and then changes to the unoccupied state. If set to 0 the unoccupied state is entered when UNOCCUPIED (2) is received.

Ignore_Time (Read/Write)

This proprietary property (property ID 541) holds the occupancy ignore time after switching off the light in seconds.

Occupied_Level (Read/Write)

This proprietary property (property ID 542) holds the output levels adopted in the presence modes in occupied state.

Unoccupied_Level (Read/Write)

This proprietary property (property ID 543) holds the output levels adopted in the presence modes in unoccupied state.

Step_Value (Read/Write)

This proprietary property (property ID 544) holds the step value for constant light controller algorithm in percent. It defines the maximum step size that the constant light controller will take to approach the target illumination. Per second the light level is not changed more than the percentage value defined by this configuration property.

On_Hysteresis (Read/Write)

This proprietary property (property ID 545) holds the constant light controller algorithm hysteresis for switching lights on (percent).

The hysteresis is used in CONTROL or REGULATOR mode.

Off_Hysteresis (Read/Write)

This proprietary property (property ID 546) holds the constant light controller algorithm hysteresis for switching lights off (percent).

The hysteresis is used in CONTROL or REGULATOR mode.

Off_Delay (Read/Write)

This proprietary property (property ID 547) holds the constant light controller off delay in seconds.

On_Delay (Read/Write)

This proprietary property (property ID 548) holds the constant light controller on delay in seconds.

Lamp_2_Offset (Read/Write)

This proprietary property (property ID 550) defines the maximum offset between the output for the primary light band and the secondary light band (see Section 6.2.4.5).

Lamp_2_Limit (Read/Write)

This proprietary property (property ID 551) specifies the dim level at which the output for the secondary light band becomes identical to the primary output (see Section 6.2.4.5).

Override (Read/Write)

This proprietary property (property ID 560) can be used to manually override the constant light controller (see Section 6.2.4.4).

If a valid value is received (0-100%), the constant light controller is disabled and the output is set to the specified value. This also affects the light bands directly linked to the constant light controller. Lamp_2_Offset and Lamp_2_Limit are not considered.

If an invalid value or a value below 0 (e.g. -1) is received, the constant light controller returns to automatic mode.

When performing an override via a DALI button the data point will reflect the resulting feedback value of the group controlled by the DALI button (see Section 6.2.4.10).

Auto_Mode (Read-only)

This proprietary property (property ID 561) provides the current state of the constant light controller (see Section 6.2.4.4).

Inactive: The constant light controller is disabled or overridden by the data point *Override* or the DALI Mode button/LCD UI.

Active: The constant light controller is enabled and not overridden by the data point *Override* or the DALI Mode button/LCD UI.

Occupancy_State (Read-only)

This proprietary property (property ID 562) provides the current occupancy state calculated by the constant light controller (see Section 6.2.4.6).

Inactive (unoccupied): The area is unoccupied.

Active (occupied): The area is occupied.

Lux_Upper_Limit (Read/Write)

By setting the proprietary property (property ID 566) to a value greater than 0 the museum mode is activated. In museum mode the constant light controller cooperates with the sunblind controller to ensure that the measured lux level stays between *Setpoint* and *Lux_Upper_Limit*. Therefore sunblind controller objects have to be enabled and a sunblind controller has to be linked to the constant light controller by writing the constant light controller index to the parameter *Linked_CLC* of the sunblind controller for this property to become effective.

Sblnd_Hyst (Read/Write)

This proprietary property (property ID 568) applies only for museum mode. It defines by which percentage the lamp dim value is increased before letting more sunlight in by opening the sunblinds. Therefore sunblind controller objects have to be enabled and a sunblind controller has to be linked to the constant light controller by writing the constant light controller index to the parameter *Linked_CLC* of the sunblind controller for this property to become effective.

6.2.5 Button Objects

The current state of a DALI button input can be represented by a BACnet Binary Input object.

6.2.5.1 Creating BACnet Objects for DALI Button Inputs

To create BACnet Binary Input objects representing DALI button inputs proceed as follows:

1. Enable Button objects in the BACnet project settings in the LINX Configurator (see LINX Configurator User Manual [2]).

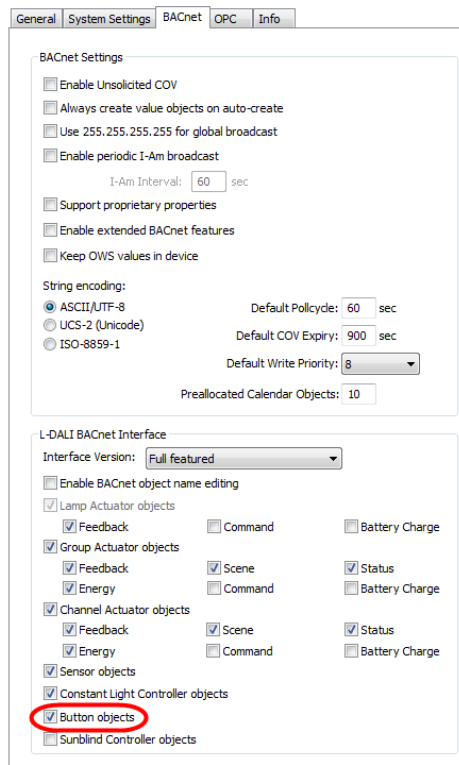

- Select the DALI button device type in the DALI Installation tab.

Button objects (0/64)

Button Name	Type	Status	Short Addr.	Serial Nr.
0 Button 00	LDALI-BM1	Unassigned (modified)	-	-
1 Button 01	unknown button	Unassigned	-	-
2 Button 02	unknown button	Unassigned	-	-
3 Button 03	unknown button	Unassigned	-	-
4 Button 04	unknown button	Unassigned	-	-
5 Button 05	unknown button	Unassigned	-	-
6 Button 06	unknown button	Unassigned	-	-
7 Button 07	unknown button	Unassigned	-	-
8 Button 08	unknown button	Unassigned	-	-
9 Button 09	unknown button	Unassigned	-	-

- In the DALI Parameters tab set the button function for the input to “Network Data Point”.

Button	Mode	Function
T1	push-button	Network data point
T2	push-button	Disabled
T3	push-button	Disabled
T4	push-button	Disabled

For each button input with the button function set to “Network Data Point” a separate Binary Input object will be created. All button inputs belonging to the same DALI button device will be grouped in a folder.

Note: BACnet objects for DALI button inputs can only be created in the LINX Configurator. Setting the button function to “Network Data Point” in the web interface will not create a BACnet object.

6.2.5.2 Binary Input Object – Button State

This object is used to represent the button state of DALI button input (see Table 22). The objects are created if required (see Section 6.2.5.1).

Property Identifier	Property ID	Property Datatype	Conformance Code	Data Point
Object_Identifier	75	BACnetObjectIdentifier	R	
Object_Name	77	CharacterString	R	✓
Object_Type	79	BACnetObjectType	R	
Present_Value	85	BACnetBinaryPV	R	✓
Status_Flags	111	BACnetStatusFlags	R	
Event_State	36	BACnetEventState	R	
Reliability	103	BACnetReliability	R	✓
Out_Of_Service	81	BOOLEAN	W	
Polarity	84	BACnetPolarity	W	
Inactive_Text	46	CharacterString	W	
Active_Text	4	CharacterString	W	
Profile_Name	168	CharacterString	R	

Table 26: Properties of the Binary Input object representing a DALI button input.

Object_Identifier (Read-Only)

The instance number is 1BCCDD, where “B” is the DALI interface number (0-3) in decimal, “CC” is the DALI device number (00-63) and “DD” is the input number (00-99). Example: Input “T2” of a LDALI-BM1 assigned to DALI button 4 on channel 2 has the instance number 110401.

Object_Name (Read-Only)

This property holds the value of the button device as configured in the LINX Configurator DALI Installation tab, complemented by the name of the button input (e.g. "T2").

Object_Type (Read-Only)

The value of this property is BINARY_INPUT (3).

Present_Value (Read-Only)

This property reports the button input status. If the *Polarity* property is *NORMAL* the value *ACTIVE* corresponds to a closed input, while the value *INACTIVE* corresponds to an open input.

Status_Flags (Read-Only)

Of the four flags the flags IN_ALARM, FAULT, and OUT_OF_SERVICE are linked to the state of the corresponding properties *Event_State*, *Reliability* and *Out_Of_Service* as described by the standard.

OVERRIDDEN Always FALSE.

Reliability (Read-Only)

The *Reliability* property for this object type may have any of the following values:

NO_FAULT_DETECTED No fault was detected.

NO_SENSOR No button assigned or some failure reported by the DALI button.

COMMUNICATION_FAILURE Button offline.

UNRELIABLE_OTHER Other failure detected.

Profile_Name (Read-only)

The value of this property is "178-http://www.loytec.com/xsd/DALIButton/v1".

6.2.6 Sunblind Controller Objects

The L-DALI models supporting SMI provide 16 sunblind controller instances for each DALI channel. The sunblind controller application can control sunblinds via a local SMI interface (e.g. LSMI-804) or via its BACnet interface.

6.2.6.1 Glare Protection

The sunblind controller can automatically control the connected sunblind actuator to provide glare protection. To do so the sunblind controller needs to know the geometry of the sunblind blades.

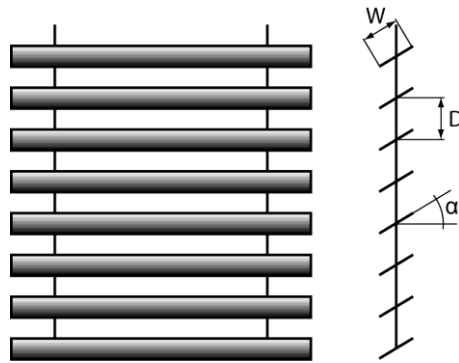

Figure 92: Sunblind Geometry

The blade distance (D) has to be configured in the configuration register *Blade_Distance* and the blade width in *Blade_Width*. The minimum and maximum rotation angle (α) is configured in *Min_Rotation* and *Max_Rotation*. Based on this geometry data and the current sun elevation (BACnet object *Sun_Elevation*) the glare protection algorithm calculates the rotation angle for the blades. The rotation angle can be optimized for a specific sunblind type by specifying an offset in the configuration register *Rotation_Offset*.

The following inputs and configuration parameters determine if glare protection is necessary:

- Sun Azimuth (BACnet object *Sun_Azimuth*): Depending on the orientation of the window, the sun can only shine into the room from a certain azimuth in the morning (configuration register *Min_Azimuth*) to a certain azimuth in the evening (configuration register *Max_Azimuth*).
- Outdoor lux level (BACnet object *Outdoor_Lux*): The glare protection will be activated if the measured outdoor lux level is above *Glare_Limit_High*. If the outdoor lux level falls below *Glare_Limit_Low* the glare protection will be deactivated. These two configuration registers implement a hysteresis.
- Surrounding buildings/objects: The BACnet Binary Value object *Glare* can be used to provide geometry information on surrounding buildings/objects. During times when the window is the shadow of a surrounding building/object *Glare* is set inactive, otherwise active.

6.2.6.2 View Protection

To protect rooms against prying eyes the sunblind can be closed automatically when the indoor light is switched on and the outdoor light level (BACnet object *Outdoor_Lux*) falls below the indoor light level (BACnet object *Indoor_Lux*). To avoid that the sunblind opens and closes repeatedly a hysteresis can be configured using the configuration register *View_Protection_Hysteresis*.

6.2.6.3 Heating/Cooling

If the room is not occupied, the L-DALI can close the sunblind to provide thermal isolation in order to save energy.

The Analog Value Object *Terminal_Load* is used to inform the controller of the current heating/cooling demand of the system. Positive values indicate that cooling energy is required, while negative values indicate that heating energy is required.

The algorithm takes the following parameters into account:

- **Outdoor lux level (BACnet object *Outdoor_Lux*):** The energy of the sun can be used to warm a room. The configuration register *Outdoor_Lux_Limit_High* defines the lux level above which the sun energy will make a noticeable contribution to warm the room if the sunblind is open. The configuration property *Outdoor_Lux_Limit_Low* define the lux level below which the sun energy is too low to warm the room. To avoid that the sunblind opens and closes repeatedly a hysteresis can be specified using the configuration register *Outdoor_Lux_Hysteresis*.
- **Temperature:** The outdoor temperature (BACnet object *Outdoor_Temp*) is compared with the indoor temperature (BACnet object *Indoor_Temp*). Depending on whether the system is in heating or in cooling mode and on the temperature difference the sunblinds are closed to increase thermal isolation of the room. To avoid that the sunblind opens and closes repeatedly a hysteresis can be specified using the configuration register *Outdoor_Temp_Hysteresis*.

6.2.6.4 Emergency Control

The sunblind controller offers the following emergency operating modes:

- **Wind Alarm:** If the *Present_Value* of the BACnet Analog Value object *Wind_Speed* is above the value of the configuration register *Wind_Limit* the sunblind controller will open the sunblinds. This measure prevents damage on sunblinds due to high winds.
- **Rain Alarm:** If the *Present_Value* of the BACnet Binary Value object *Rain* is active the sunblind controller will open the sunblinds. This measure prevents potential damage of the sunblinds due to becoming wet.
- **Frost Alarm:** If the *Present_Value* of the BACnet Binary Value object *Frost* is active the sunblind controller will stop movement and remain on its current position. This measure prevents potential damage of the sunblinds or the attached drive due to blades being frozen.
- **Weather Sensor Offline Alarm:** If no update was received on the *Present_Value* of the BACnet object *Wind_Speed*, *Rain* or *Frost* within the time configured in the configuration registers *Wind_Rcv_Timeout*, *Rain_Rcv_Timeout* or *Frost_Rcv_Timeout* respectively the sunblind controller will perform the action configured in the configuration register *Weather_Fail_Pos*. This allows monitoring weather sensor health and taking preventive measures in case a sensor fails.
- **Window Contact Alarm:** If the *Present_Value* of the BACnet Binary Value object *Window_Contact* is inactive the sunblind controller will stop movement and remain on its current position. This measure prevents injury due to moving sunblinds in case the window is opened.
- **Window Contact Offline Alarm:** If no update was received on the *Present_Value* of the BACnet object *Window_Contact_Speed* within the time configured in the configuration registers *Window_Rcv_Timeout* the sunblind controller will perform the action configured in the configuration register *Window_Contact_Fail_Pos*. This allows monitoring window contact sensor health and taking preventive measures in case a sensor fails.

6.2.6.5 Museum Mode

For the museum mode of the constant light controller (see Section 6.2.4.12) a sunblind controller must be linked to the constant light controller.

6.2.6.6 Occupancy Detection

The occupied/unoccupied status of the room can be determined by an occupancy sensor. To connect an occupancy sensor via the BACnet network the BACnet Binary Value object *Occupancy* is used. Its behavior is identical to the proprietary property *Occupancy_Variable_Value* of the Constant Light Controller object (see Section 6.2.4.6).

6.2.6.7 BACnet Object Interface

There is a set of objects representing the sunblind controller functionality on the BACnet interface.

Command Input

In general a sunblind is controlled by two values – Position and Rotation. Further, the sunblind can be controlled by directly commanding the target position and rotation or by relative commands (e.g. move up, down, open, close and stop). Therefore a set of BACnet Output objects representing the sunblind controller input is required:

- **Command (Multi-State):** Determines the type of sunblind movement requested. SET_STATE allows absolute positioning, while SET_UP, SET_DOWN and SET_STOP allows relative sunblind movements.
- **Position (Analog):** Determines the absolute position (SET_STATE) or the relative position increment or decrement (SET_UP and SET_DOWN respectively) in percent. 0% corresponds to open, while 100% corresponds to closed sunblinds.
- **Rotation (Analog):** Determines the absolute blind rotation (SET_STATE) or the relative rotation increment or decrement (SET_UP and SET_DOWN respectively) if supported by the sunblind.

To avoid a glitch in case not all three objects are written at once, the evaluation of the three independent BACnet objects is done as follows:

- If *Command* is SET_STATE and the *Present_Value* of all three objects are on the same priority changes of *Position* and *Rotation* are evaluated without delay.
- If *Command* is SET_STOP, it is only evaluated if *Position* and *Rotation* are on the same priority (even though they are not used for STOP).
- If *Command* is SET_UP or SET_DOWN, *Position* and *Rotation* are only evaluated if *Command* is written and all three data points are on the same priority. Further, no sunblind movement is triggered in case these values come in effect due to a higher priority value being relinquished. Thus, UP/DOWN commands are only executed when they are highest priority at the time they are written. This is necessary since the commands trigger a movement relative to the current position and are usually triggered by user inputs. Thus, they are only valid at the time they are given. If not executed instantly the command should be dropped.
- All other values or value combinations written are ignored and do not lead to any sunblind movement.

These three command input objects can be used for manual operation via BACnet, but are also used for automatic operation. Different control algorithms (e.g. glare protection, heating/cooling support, view protection, etc.) in the sunblind controller applications use different, configurable priorities (see Section 6.2.6.8). Thus, the BACnet priority array mechanism is used to determine the highest pending event.

Sunblind Feedback

To provide the current position and rotation as feedback via the BACnet interface the Analog Input objects *Position_Fb* and *Rotation_Fb* are available for each sunblind controller instance. If SMI sunblinds are connected via internal sunblind bindings, the *Present_Value* of these objects reflects the position and rotation reported by the SMI drives. Otherwise, the values correspond to the values provided with the latest SET_STATE command and are invalid if the position or rotation was changed by relative commands (SET_UP, SET_DOWN, SET_STOP).

Sunblind Controller Algorithm Inputs

The inputs used by the sunblind controller algorithm are also available as BACnet objects. There are two types of inputs:

- Inputs available for each sunblind controller instance (**individual**).
- Inputs available for a sunblind controller channel (**global**). A sunblind controller channel is a group of 16 sunblind controller instances, which share a common set of global inputs.

Sunblind Controller BACnet Objects (individual)

Table 27 shows a list of all BACnet objects belonging to a Sunblind Controller instance. The column Object ID contains the objects default instance number, where “B” is the Sunblind Controller channel number (0-3) in decimal, and “CC” is the Sunblind Controller instance on the channel (00-15).

Object Name Suffix	Object Type	Object ID	Description
Command	MO	10BCC	Sunblind controller command input.
Position	AO	10BCC	Sunblind controller position input.
Rotation	AO	11BCC	Sunblind controller rotation input.
Position_Fb	AI	10BCC	Sunblind controller current position.
Rotation_Fb	AI	11BCC	Sunblind controller current rotation.
Indoor_Temp	AV	10BCC	This object is used to provide the room temperature measured by a temperature sensor. This input is used if the sunblinds are used for heating/cooling (see Section 6.2.6.3).
Terminal_Load	AV	11BCC	This object is used if the sunblinds are used for heating/cooling (see Section 6.2.6.3). The input informs the controller of the current heating/cooling demand. Positive values indicate that cooling energy is required, while negative values indicate that heating energy is required.
Indoor_Lux	AV	12BCC	This object is used to provide the illumination level in the room. The input is used for view protection (see Section 6.2.6.2). If <i>Indoor_Lux</i> is higher than the <i>Outdoor_Lux</i> then the sunblind is closed to protect the room against prying eyes.
Window_Contact	BV	10BCC	This object is used to inform the controller if the window is open (inactive) or close (active). If the window is open, the sunblind stops moving (see Section 6.2.6.4).
Occupancy	BV	11BCC	This object is used to provide the occupancy state measured by an occupancy sensor. A hold time can be configured using the configuration register <i>Hold_Time</i> (see Section 6.2.6.6).
Glare	BV	12BCC	This object is used to activate the automatic glare protection for the sunblind controller instance (see Section 6.2.6.1). It can be used to deactivate the automatic glare protection, in case a structure (e.g. building, mountain, etc.) currently drops a shadow on the window.

Table 27: Sunblind Controller BACnet Objects (individual)

Sunblind Controller BACnet Objects (global)

Table 28 shows a list of all BACnet objects shared between all Sunblind Controller instances of a channel. The column Object ID contains the objects default instance number, where “B” is the Sunblind Controller channel number (0-3) in decimal.

Object Name Suffix	Object Type	Object ID	Description
Outdoor_Temp	AV	1900B	This object is used to provide the current outdoor temperature. This input is used when the sunblinds are used to support heating/cooling (see Section 6.2.6.3).
Outdoor_Lux	AV	1901B	This object is used to provide the current outdoor illumination measured by a light sensor. It is used for glare protection, view protection and heating/cooling support (see Sections 6.2.6.1, 6.2.6.2 and 6.2.6.3)
Wind_Speed	AV	1902B	This object is used to provide the current wind speed measured by a wind sensor. If the wind speed is higher than the value configured in <i>Wind_Limit</i> , the sunblinds must go up (see Section 6.2.6.4).
Rain	BV	1900B	This object is used to notify the sunblind controller, whether it rains (active) or not (inactive). If it is raining, the sunblinds must go up (see Section 6.2.6.4).
Frost	BV	1901B	This object is used to notify the sunblind controller, whether there is the risk to freezing (active) or not (inactive). If a frost condition is detected, the sunblinds must not move to prevent damage to the blades or the blind’s motor (see Section 6.2.6.4).
Sun_Elevation	AV	1903B	This object is used to provide provides the current sun elevation. The elevation is the angle between the horizon and the middle of the sun, considered out of the viewpoint of an observer. The values 0 – 90° are typically used (0= Sunrise/Sunset; 90 = zenith position). This value is used by the glare protection algorithm to calculate the blade angle (see Section 6.2.6.1).
Sun_Azimuth	AV	1904B	This object is used to provide provides the current sun azimuth. The values 0 – 359° are typically used (0 = NORTH, 90 = EAST, 180 = SOUTH, 270 = WEST). This value is used by the glare protection algorithm to determine whether there can be glare depending on the direction of the window (see Section 6.2.6.1).

Table 28: Sunblind Controller BACnet Objects (global)

6.2.6.8 Sunblind Controller Events and Priorities

The operation of the sunblind controller is influenced by a number of events. Table 29 describes the different events and shows their default BACnet priority.

The BACnet priority of events can be changed. Events can be deactivated by setting the priority to 0. Usually this is done on the DALI Parameters tab of the LINX Configurator (see LINX Configurator User Manual [2]).

The BACnet priority of an event is used when the Sunblind controller application writes a value originating from that event to the Command Input objects (see Section 6.2.6.7) of the sunblind controller instance.

Priority	Event	Description
1 (highest)	Weather sensor alarm*	<p>At least one of the (global) weather sensors failed:</p> <ul style="list-style-type: none"> No update has been received on <i>Wind_Speed</i> for longer than <i>Wind_Rcv_Timeout</i>. No update has been received on <i>Rain</i> for longer than <i>Rain_Rcv_Timeout</i>. No update has been received on <i>Frost</i> for longer than <i>Frost_Rcv_Timeout</i>. <p>In case of a weather sensor alarm the sunblind drives to the position defined by <i>Weather_Fail_Pos</i>.</p>
2	Window sensor alarm*	<p>Window sensor failed: No update has been received on <i>Window_Contact</i> for longer than <i>Window_Rcv_Timeout</i>.</p> <p>In case of a window sensor alarm the sunblind drives to the position defined by <i>Window_Contact_Fail_Pos</i>.</p>
3	Frost condition*	<p>The sunblind controller enters the frost state if the Binary Value object <i>Frost</i> is in active state. When <i>Frost</i> becomes inactive the sunblind controller remains in the frost state for the hold time configured in <i>Weather_Off_Delay</i>.</p> <p>The sunblind does not move as long as the sunblind controller is in the frost state.</p>
4	Wind*	<p>The sunblind controller enters the wind alarm state if the measured wind speed (<i>Wind_Speed</i>) exceeds the threshold configured in <i>Wind_Limit</i>. When the wind speed falls below the threshold the sunblind controller remains in the wind alarm state for the hold time configured in <i>Wind_Off_Delay</i>.</p> <p>The sunblind remains open while the sunblind controller is in the wind alarm state.</p>
5	Rain condition*	<p>The sunblind controller enters the rain state if the Binary Value object <i>Rain</i> is in active state. When <i>Rain</i> becomes inactive the sunblind controller remains in the rain state for the hold time configured in <i>Weather_Off_Delay</i>.</p> <p>The sunblind remains open while the sunblind controller is in the rain state.</p>
6	Window open*	<p>The window is open: The Binary Value object <i>Window_Contact</i> is in active state. The polarity of the window contacts can be changed via the configuration register <i>Invert_Window_Contact</i>.</p> <p>The sunblind does not move as long as the window is open.</p>
12	Anti-glare*	<p>The sunblind is controlled by the anti-glare algorithm. Only active if room is occupied. See Section 6.2.6.1 for detail.</p>
13	View protection*	<p>The sunblind is controlled by the view protection algorithm. Only active if room is occupied. See Section 6.2.6.2 for detail.</p>
14	Constant light request*	<p>The sunblind is linked to the constant light controller and is controlled by the museum mode algorithm. Only active if room is occupied. See Section 6.2.6.5 for detail.</p>
15	Up if occupied*	<p>The room is occupied. See Section 6.2.6.6 for detail.</p> <p>If the room is occupied the sunblind moves up.</p>
16 (lowest)	Heat/cool request*	<p>The sunblind is controlled by the heating/cooling algorithm. Only active if room is not occupied. See Section 6.2.6.3 for detail.</p>

Table 29: Sunblind Controller Events and Priority

For events marked with *) a minimum time can be configured via the configuration register *Auto_Event_Time*. These events will stay active for at least the configured time even if the event condition disappears before this time expires. In this way the sunblind controller ensures that the sunblind does not drive too frequently.

In case none of the events is active the sunblind remains in its current position.

6.2.6.9 Configuration Parameters

Table 30 lists all Sunblind Controller instance specific configuration parameters (individual), while Table 31 lists all configuration parameters shared between the Sunblind Controller instances of a channel (global). All configuration parameters are implemented as registers and are thus not available via the BACnet interface.

Parameter	Description
Window_Rcv_Timeout	This configuration register specifies the expected update interval of the <i>Present_Value</i> of the <i>Window_Contact</i> object. If the time elapses without an update an alarm is generated and the sunblind adopts the safe position defined by the <i>Window_Contact_Fail_Pos</i> (see Section 6.2.6.4).
Window_Contact_Fail_Pos	This configuration register defines the safety position of a sunblind when a failure of the window contact (<i>Window_Contact</i>) has been detected (see Section 6.2.6.4).
Drive_Delay	This configuration register defines the delay which the sunblind controller waits before it updates its outputs. If different drive delays are configured for the different sunblind controllers, the sunblinds will not drive at the same time avoiding a power peak. Drive delay is only applied for automatic operation.
Glare_Limit_High	This configuration register defines the high limit for the <i>Outdoor_Lux</i> input hysteresis as used by the automatic glare detection algorithm (see Section 6.2.6.1). If the lux level is above this value the glare protection algorithm is activated.
Glare_Limit_Low	This configuration register defines the low limit for the <i>Outdoor_Lux</i> input hysteresis as used by the automatic glare detection algorithm (see Section 6.2.6.1). If the lux level is above this value the glare protection algorithm is deactivated.
Min_Azimuth	This configuration property defines the minimum azimuth for the <i>Sun_Azimuth</i> input used by the automatic glare detection algorithm (see Section 6.2.6.1). It therefore defines the direction of the window (together with <i>Max_Azimuth</i>).
Max_Azimuth	This configuration property defines the maximum azimuth for the <i>Sun_Azimuth</i> input used by the automatic glare detection algorithm (see Section 6.2.6.1). It therefore defines the direction of the window (together with <i>Min_Azimuth</i>).
Blade_Distance	This configuration register defines the distance between sunblind blades (see Section 6.2.6.1).
Blade_Width	This configuration register defines the width of the sunblind blades (see Section 6.2.6.1).
Rotation_Offset	This configuration register defines the rotation offset for the glare protection algorithm (see Section 6.2.6.1).
Max_Rotation	This configuration register defines the maximum rotation for the glare protection algorithm (see Section 6.2.6.1).
Min_Rotation	This configuration register defines the minimum rotation for the glare protection algorithm (see Section 6.2.6.1).
Hold_Time	This configuration register defines the hold time for the occupied state. When the ACTIVE value is received via the <i>Present_Value</i> of the <i>Occupancy</i> object the sunblind controller remains in the occupied state until the hold time has expired and then changes to the unoccupied state. If set to 0 the unoccupied state is entered when value INACTIVE is received (Section 6.2.6.6).

Parameter	Description
Auto_Event_Time	<p>Use to specify the minimum time for the following events:</p> <ul style="list-style-type: none"> • Weather sensor alarm • Window sensor alarm • Frost condition • Wind • Rain condition • Window open • Anti-glare • View protection • Constant light request • Up if occupied • Heating/cooling request <p>The event will stay active for at least the configured time even if the event condition disappears before this time expires. In this way the sunblind controller ensures that the sunblind does not drive too frequently.</p>

Table 30: Sunblind Controller Configuration Parameters (individual).

Parameter	Description
Wind_Rcv_Timeout	This configuration register specifies the expected update interval of the <i>Present_Value</i> of the <i>Wind_Speed</i> object. If the time elapses without an update an alarm is generated and the sunblinds adopt the safe position defined by <i>Weather_Fail_Pos</i> (see Section 6.2.6.4).
Wind_Limit	This configuration register defines the maximum wind for the sunblinds. If the current wind speed (<i>Wind_Speed</i>) is greater than this the sunblinds must go up (see Section 6.2.6.4).
Wind_Off_Delay	This configuration register defines the time for which the current wind speed (<i>Wind_Speed</i>) must be below the critical wind speed (<i>Wind_Limit</i>) before the sunblind controller return to normal operation (see Section 6.2.6.4).
Rain_Rcv_Timeout	This configuration register specifies the expected update interval of the <i>Present_Value</i> of the <i>Rain</i> object. If the time elapses without an update of the variable an alarm is generated and the sunblinds adopt the safe position defined by <i>Weather_Fail_Pos</i> (see Section 6.2.6.4).
Frost_Rcv_Timeout	This configuration register specifies the expected update interval of the <i>Present_Value</i> of the <i>Frost</i> object. If the time elapses without an update of the variable an alarm is generated and the sunblinds adopt the safe position defined by <i>Weather_Fail_Pos</i> (see Section 6.2.6.4).
Weather_Off_Delay	This configuration register defines the time for which the rain/frost condition (<i>Rain/Frost</i>) has to be inactive before the sunblind controller returns to normal operation (see Section 6.2.6.4).
Weather_Fail_Pos	This configuration register defines the safety position of sunblinds when a failure of a safety relevant weather sensor (e.g. <i>Wind_Speed</i> , <i>Rain</i> or <i>Frost</i>) is detected (see Section 6.2.6.4).
Invert_Window_Contact	This configuration register allows inverting the window contact inputs (<i>Window_Contact</i>) of the sunblind controllers (see Section 6.2.6.4).
Outdoor_Temp_Hysteresis	This configuration register defines the hysteresis for the outdoor temperature (<i>Outdoor_Temp</i>). It is used for the heating/cooling algorithm (see Section 6.2.6.3).
Outdoor_Lux_Hysteresis	This configuration register defines the hysteresis for the outdoor lux level input (<i>Outdoor_Lux</i>). It is used by the heating/cooling algorithm (see Section 6.2.6.3).
Outdoor_Lux_Limit_High	This configuration register defines the high limit for the outdoor lux level input (<i>Outdoor_Lux</i>). It is used by the heating/cooling algorithm (see Section 6.2.6.3).
Outdoor_Lux_Limit_Low	This configuration register defines the low limit for the outdoor lux level input (<i>Outdoor_Lux</i>). It is used by the heating/cooling algorithm (see Section 6.2.6.3).

Parameter	Description
View_Protection_Hysteresis	This configuration register defines the hysteresis for the outdoor lux level input (<i>Outdoor_Lux</i>). It is used by the view protection algorithm (see Section 6.2.6.2).

Table 31: Sunblind Controller Configuration Parameters (global).

6.3 Web Interface

6.3.1 Constant Light Controller Bindings (Commission)

To determine which sensors (occupancy & lux) are used as inputs to and which light groups are controlled by a constant light controller instance and which constant light controller instances are linked together go to the **CLC Bindings** page (see Figure 93).

Again, selected the DALI channel by clicking on the different tabs at the top of the page labeled **Channel 1**, **Channel 2**, etc.

Click on the **+** symbol to add an input or output. Use the drop down box to select a sensor (occupancy/lux) instance or a data point.as input and a light group as output. Click on **×** symbol to remove an input or output.

The screenshot shows the 'CLC Bindings' page for Channel 1. The page has a sidebar on the left with navigation options: Device Info, Data, Commission (with sub-items: CLC Bindings, DALI Groups, DALI Installation, DALI Scene, EnOcean, OPC XML-DA Client, SBC Bindings), Config, Statistics, L-WEB, Documentation, Reset, Contact, and Logout. The main content area is titled 'CLC Bindings' and has tabs for Channel 1, Channel 2, Channel 3, and Channel 4. Below the tabs are 'Save' and 'Reload' buttons, and an 'Automatic internal binding' checkbox. The main table lists bindings for 'Constant Light Controller 0 (R302 Center)'. The table has columns for 'Type' and 'Binding'. The rows are: 'Lux sensor' (NV unbound) with a dropdown for 'Ch1: Light Sensor 0 (R302 Sensor Center)', a '-- lux' label, and 'Calibrate' and 'Wink' buttons; 'Occupancy' (NV unbound) with a dropdown for 'Ch1: Occupancy Sensor 0 (R302 Sensor Center)' and an 'unknown' label; 'Light Band 1' (NV unbound) with a dropdown for 'Ch1: Group Actuator 0 (R302 Center Window)' and a '0 %' label; 'Light Band 2' (NV unbound) with a dropdown for 'Ch1: Group Actuator 1 (R302 Center Corridor)' and a '0 %' label; and 'Neighboring Controller' with a dropdown for 'Ch1: Constant Light Controller 1 (R302 Left)' and 'Ch1: Constant Light Controller 2 (R302 Right)'. Each row has a '+' icon to add and a '-' icon to remove.

Figure 93: CLC Bindings.

For each constant light controller one lux level sensor, but up to 16 occupancy sensor inputs can be configured. Whenever at least one occupancy sensor reports occupancy the area controlled by the controller instance is considered occupied. The drop down box allows to select a DALI sensor (occupancy/lux) instance or a data point.

To select a data point select **Choose data point...** from the drop down box. The dialog shown in Figure 94 appears. Click on **Choose** and select the intended data point. Any analog data point can be selected as lux sensor, a binary data point as occupancy sensor. For the latter select, which value shall be considered as unoccupied and which as occupied.

Data Point	<input type="text" value="/EnOcean/test/PIR Status"/>	<input type="button" value="Choose"/>
Unoccupied value	<input type="text" value="PIR off"/>	
Occupied value	<input type="text" value="PIR on"/>	
		<input type="button" value="Cancel"/> <input type="button" value="Save"/>

Figure 94: Use data point as CLC input.

Similar for each of the two light bands up to 16 DALI groups can be selected as outputs. The primary light band is near the inside of the building, the secondary light band is near the window front. Depending on the outdoor light intensity the primary light band has to be brighter than the secondary light band to illuminate the room evenly.

In addition to inputs and outputs **Neighboring Controller** instances can be selected in open office space application scenarios. For additional information on the interaction of neighboring controller instances see Sections 6.1.4.9 and 6.2.4.9.

On the LDALI-10X NV bindings can be used in parallel to the internal CLC bindings. The binding status of the corresponding NV is displayed (NV bound/unbound). To enable manual internal CLC bindings the automatic binding algorithm has to be disabled by unchecking the **Automatic internal binding** checkbox. See Section 6.1.4.1 for details on the automatic internal binding algorithm.

On the LDALI-20X the BACnet **Write priority** for the outputs (light bands) can be configured. This priority will be used by the Constant Light Controller application to write to the corresponding Analog Output object controlling the light group.

Once at least one output is configured the button **Find sensors** appears. Click on the button to start a wizard, which automatically tries to find the DALI sensors belonging to the configured light bands. The wizard will switch the light bands on and off. All sensors, which change their lux level reading when switching lights on and off will be considered to belong to the constant light controller instance. The wizard will chose one of the sensors as lux sensor and will add all sensors as occupancy sensor.

Click on the name to jump to the data point configuration page of the fieldbus object corresponding to the Constant Light Controller instance. Once saved the current lux and occupancy sensor reading and the current light level output of the configured groups will be displayed.

To calibrate a lux level sensor click on the **Calibrate** button next to it. This will open the DALI Sensor Calibration page as described in the LOYTEC Devices User Manual [1], with the sensor's Constant Light Controller instance selected.

6.3.2 Sunblind Controller Bindings (Commission)

To determine which DALI sensors (occupancy & lux) are used as inputs to and which SMI drives are controlled by a sunblind controller instance go to the **SBC Bindings** page (see Figure 95).

Selected the sunblind controller channel by clicking on the different tabs at the top of the page labeled **Channel 1**, **Channel 2**, etc.

Click on the **+** symbol to add an input or output. Use the drop down box to select a DALI sensor (occupancy/lux) instance or a data point.as input and a SMI drive as output. SMI drives must be created in the LINX Configurator as described in the LINX Configurator User Manual [2] to be available for selection. To select a data point as input select **Choose data point...** from the drop down box. The dialog shown in Figure 94 appears. Click on **Choose** and select the intendet data point. Any analog data point can be selected as lux sensor, a binary data point as occupancy sensor. For the latter select, which value shall be considered as unoccupied and which as occupied. Click on **X** symbol to remove an input or output.

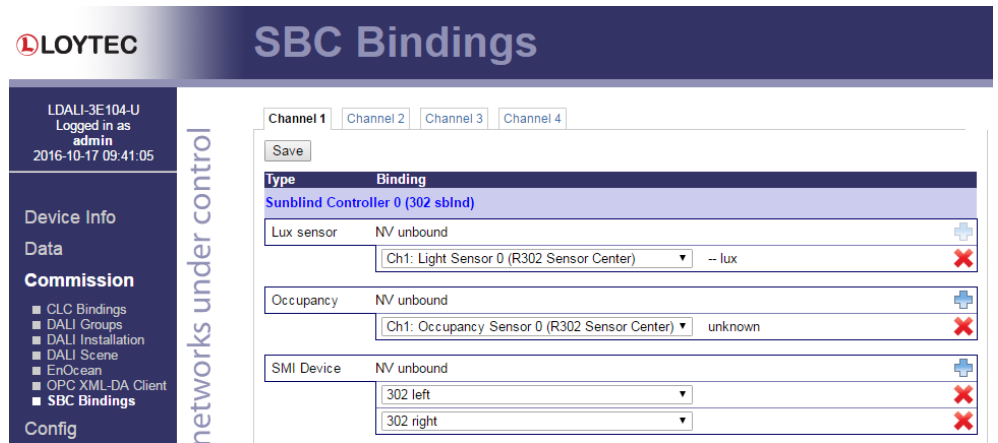

Figure 95: SBC Bindings.

For each sunblind controller one lux level sensor, but up to 16 occupancy sensor inputs can be configured. Whenever at least one occupancy sensor reports occupancy the area controlled by the controller instance is considered occupied. Similar up to 16 SMI drives can be selected as outputs for each sunblind controller instance.

On the LDALI-10X NV bindings can be used in parallel to the internal SBC bindings. The binding status of the corresponding NV is displayed (NV bound/unbound).

Click on the name to jump to the data point configuration page of the fieldbus object corresponding to the Sunblind Controller instance. Once saved the current lux and occupancy sensor reading will be displayed.

6.3.3 Configuration of Button Functions

To configure the function to be performed, when a button is pressed go to the **Buttons** page (see Figure 96).

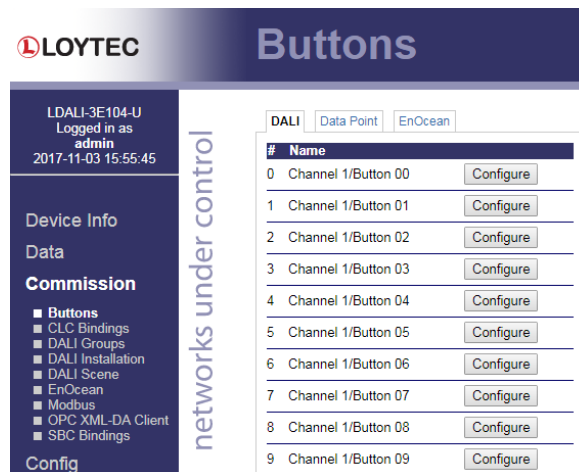

Figure 96: Button Functions.

Currently, button functions can be configured for the following entities:

- **DALI buttons:** See the DALI section in the LOYTEC Devices User Manual [1] for information on which DALI button devices are supported.
- **EnOcean buttons:** Profiles Rocker Switch, 2 Rocker (F6-01) and 4 Rocker (F6-03), and Position Switch (F6-04) are supported. EnOcean devices must be created in the

LINX Configurator before being available for button function configuration (see LINX Configurator User Manual [2]).

- **Data Points:** Any binary data point can be used to trigger button functions. Data points can be used to configure button functions for buttons created in L-WEB graphic projects, for buttons connected to digital inputs of remote IO modules (e.g. BACnet, LONMARK, etc.) and for DALI buttons connected to DALI channels on other L-DALI controllers. Data points must be selected as trigger for a button function in the LINX Configurator before being available for button function configuration (see LINX Configurator User Manual [2]).

On the **Buttons** page, first choose the click on the **Configure** button next to the button device that is to be configured. The dialog shown in Figure 97 appears.



Figure 97: Configure DALI button functions.

For buttons which can be operated as push-button or as switch the **Mode** drop down box allows to select whether a switch or a push button is connected to the button input. The **Function** drop down box allows selecting the function to be performed when the button is pressed. See Table 32 for a list of available function. If the function is used to control light, the **Destination** column allows selecting the DALI group or channel to be controlled. For functions to operate sunblinds the affected sunblind controller application instance can be chosen. If the function requires additional arguments (e.g. dim values or scene numbers) they are configured in the columns **Argument 1** and **Argument 2**.

If multiple buttons require identical or similar configuration those buttons can be selected in the **Copy settings to** selection box. Click on **Apply** to write the configuration to the button device, **Save** to save and close the dialog.

If buttons are used with L-DALI Constant Light Controller applications to allow manual and automatic operation please see Sections 6.1.4.10 and 6.2.4.10 on how buttons can interact with the Constant Light Controller application.

Button functions controlling sunblinds use the LONMARK NV *nviLocalControl* (LDALI-10X models, see Section 6.1.5.4) or the BACnet object *Command* (LDALI-20X models, see Section 6.2.6.7) with priority 8 (Manual Operation) to control the sunblinds.

Function	Description
Disabled	No action
Network data point	Button input status will be reflected by a data point.
On (maximum)	Switch on (recall maximum).
On (last value)	Switch on to last known value. <i>Note: Requires storing value when switching off.</i>
Auto	(Re-)activate L-DALI constant light controller of target group.
Off	Switch off.
Off (store value)	Store last value and switch off.
On/Off	Toggle between on and off whenever button is pressed or switch is changed depending on current status (changeover switch). Switch light on when it is off and switch light off when it is on.
Auto/Off	Toggle between active L-DALI constant light controller and off whenever button is pressed or switch is changed depending on current status (changeover switch). Switch light on when it is off and switch light off when it is on. Note: Switching off will deactivate the L-DALI constant light controller.
Up	Dim up while button is pressed. The dim speed is determined by the fade rate parameter of each ballast.
Down	Dim down while button is pressed. The dim speed is determined by the fade rate parameter of each ballast.
Up/Down	Toggle between dimming up and down whenever button is pressed. Dim as long as button is kept pressed. The dim speed is determined by fade rate parameter of each ballast.
On/Up	Switch on (recall maximum) if button is pressed shortly, dim up when button kept pressed. The dim speed is determined by the fade rate parameter of each ballast.
On (last value)/Up	Switch on to last known value if button is pressed shortly, dim up when button kept pressed. The dim speed is determined by the fade rate parameter of each ballast.
Auto/Up	(Re-)activate L-DALI constant light controller if button is pressed shortly, dim up when button kept pressed. The dim speed is determined by the fade rate parameter of each ballast. Note: Dimming up will deactivate the L-DALI constant light controller.
Off/Down	Switch off value if button is pressed shortly, dim down when button kept pressed. The dim speed is determined by the fade rate parameter of each ballast.
Off (store value)/Down	Store last value and switch off if button is pressed shortly, dim down when button kept pressed. The dim speed is determined by the fade rate parameter of each ballast.
On/Off and Up/Down	Toggle between on and off whenever button is pressed shortly depending on current status (changeover switch). Toggle between dimming up and down whenever button is pressed longer. Dim as long as button is kept pressed. The dim speed is determined by the fade rate parameter of each ballast.
Auto/Off and Up/Down	Toggle between active L-DALI constant light controller and off whenever button is pressed shortly depending on current status (changeover switch). Toggle between dimming up and down whenever button is pressed longer. Dim as long as button is kept pressed. The dim speed is determined by the fade rate parameter of each ballast. Note: Dimming up/down and switching off will deactivate the L-DALI constant light controller.
On (last value)/Off and Up/Down	Toggle between switching on to last value and off (including storing the last value) whenever button is pressed shortly depending on current status (changeover switch). Toggle between dimming up and down whenever button is pressed longer. Dim as long as button is kept pressed. The dim speed is determined by

Function	Description
	the fade rate parameter of each ballast.
Dim to	Dim to the value entered as argument 1.
Dim to (toggle)	Toggle between dim value entered as argument 1 and dim value entered as argument 2 whenever button is pressed or switch is changed.
Recall scene	Recall the scene configured with argument 1.
Recall scene (toggle)	Toggle between recalling scene configured with argument 1 and scene configured with argument 2 whenever button is pressed or switch is changed.
Colour warmer	Ramp up colour temperature as long as button is pressed. <i>Note: Requires ballasts of type colour control (device type 8) supporting the colour type colour temperature.</i>
Colour cooler	Ramp down colour temperature as long as button is pressed. <i>Note: Requires ballasts of type colour control (device type 8) supporting the colour type colour temperature.</i>
Sunblind Up	Short Press: Rotate sunblinds until completely open, then move up. Long Press: Drive to upper end position.
Sunblind Down	Short Press: Rotate sunblinds until completely closed, then move down. Long Press: Drive to lower end position.
Sunblind Auto	Relinquish manual override of sunblind controller application and resume automatic operation.
Sunblind Up/Down/Auto	Short Press: Toggle between moving sunblinds up and down, with stop in-between (each second button press). Long Press: Relinquish manual override of sunblind controller application and resume automatic operation.

Table 32: DALI button functions

6.3.4 Debug (Config)

Log messages can be activated for each LONMARK or BACnet Object present on the L-DALI to allow analyzing the light and the sunblind applications (see Figure 98).

The debug log allows recording all changes on inputs and outputs as well as all application internal transitions in case a fieldbus object does not behave as expected. Debug logs are stored in RAM. The messages logged are in most cases self-explanatory.

Further, LOYTEC support requires a debug log to be able to analyze any potential problems. Therefore, such a log should be created before contacting LOYTEC support.

To enable debugging on one or more objects, specify the desired object(s) by setting a filter using the **Type**, **Channel** and **Object Index** drop down boxes. Then check the **Log Input/Log Output/Log State** check boxes and click on the **Save** button.

LOYTEC Debug Mask

LDALI-3E104
Logged in as admin
2015-05-28 13:33:20

networks under control

Debug Log | **Debug Mask**

Edit Debug Mask

Type: all Channel: all Object Index: all

Log Inputs
 Log Outputs
 Log State

Save

Current Debug Mask

Type	Channel	Object	Input	Output	State
group_act	0.1		yes	yes	yes
group_act	0.2		yes	yes	yes
group_act	0.3		yes	yes	yes
group_act	0.4		yes	yes	yes
group_act	0.6		yes	yes	yes
group_act	0.7		yes	yes	yes
group_act	0.8		yes	yes	yes
group_act	0.9		yes	yes	yes
group_act	0.10		yes	yes	yes
group_act	0.11		yes	yes	yes
channel_act	0.0		yes	yes	yes
light_ssr	0.0		yes	yes	yes
light_ssr	0.1		yes	yes	yes
light_ssr	0.2		yes	yes	yes
occup_ssr	0.1		yes	yes	yes
occup_ssr	0.2		yes	yes	yes
light_ctrl	0.1		yes	yes	yes

Figure 98: Setup Debug Mask.

To disable debugging select the object(s) by specifying a filter like when enabling debugging, leave the checkboxes **Log Input/Log Output/Log State** unchecked and click on the **Save** button.

LOYTEC Debug Log

LDALI-3E104
Logged in as admin
2015-05-28 13:33:55

networks under control

Debug Log | **Debug Mask**

Adjust debug log file size (maximum size 1048576)
1048576 Save

Clear Log | Update Log | Save Log

```

2015-05-28 13:03:46.139 light_ctrl.0.6 (dpal_fb_input_cov_cb) nviOccup = OC_UNOCCUPIED
2015-05-28 13:03:46.313 light_ctrl.1.1 (dpal_fb_input_cov_cb) nviLuxLevel = 5866.00
2015-05-28 13:03:46.384 light_ssr.0.1 (dpal_dev_input_cov_cb) lux = 285.00
2015-05-28 13:03:46.386 light_ssr.0.1 (dpal_dev_input_cov_cb) change (407.89) > delta (83.55)
2015-05-28 13:03:46.388 light_ssr.0.1 (set_fb_lux_level) nvoLuxLevel = 3750.00
2015-05-28 13:03:46.562 light_ctrl.0.3 (dpal_fb_input_cov_cb) nviLuxLevel = 3750.00
2015-05-28 13:03:46.622 global.0.0 (dpal_global_input_cov_cb) nviRain = 0
2015-05-28 13:03:46.632 global.1.0 (dpal_global_input_cov_cb) nviRain = 0
2015-05-28 13:03:46.727 light_ctrl.1.8 (dpal_fb_input_cov_cb) nviLuxLevel = 5485.00
2015-05-28 13:03:46.818 global.0.0 (dpal_global_input_cov_cb) nviRain = 0
2015-05-28 13:03:46.825 global.1.0 (dpal_global_input_cov_cb) nviRain = 0
2015-05-28 13:03:47.298 light_ctrl.0.4 (dpal_fb_input_cov_cb) nviOccup = OC_OCCUPIED
2015-05-28 13:03:47.298 light_ctrl.0.4 (occupancy_update) start timer hold occ (event based occupied)
2015-05-28 13:03:47.692 sbind_ctrl.1.2 (dpal_fb_input_cov_cb) nviIllumLev = 1880.00
2015-05-28 13:03:47.628 light_ctrl.1.3 (dpal_fb_input_cov_cb) nviLuxLevel = 1880.00
2015-05-28 13:03:47.717 sbind_ctrl.1.3 (dpal_fb_input_cov_cb) nviIllumLev = 1880.00
2015-05-28 13:03:47.883 light_ctrl.2.0 (dpal_fb_input_cov_cb) nviLuxLevel = 3305.00
2015-05-28 13:03:47.968 light_ctrl.1.2.3 (dpal_fb_input_cov_cb) nviLuxLevel = 8047.00
2015-05-28 13:03:48.035 light_ctrl.0.5 (dpal_fb_input_cov_cb) nviLuxLevel = 1755.00
2015-05-28 13:03:48.106 global.0.0 (dpal_global_input_cov_cb) nviSunAzimuth = 185.70
2015-05-28 13:03:48.116 global.1.0 (dpal_global_input_cov_cb) nviSunAzimuth = 185.70
2015-05-28 13:03:48.706 light_ssr.0.0 (dpal_dev_input_cov_cb) lux = 476.00
2015-05-28 13:03:48.708 light_ssr.0.0 (dpal_dev_input_cov_cb) change (553.87) > delta (84.53)
2015-05-28 13:03:48.709 light_ssr.0.0 (set_fb_lux_level) nvoLuxLevel = 3934.93
    
```

Figure 99: Debug Log.

7 Security Hardening Guide

This guide contains security-relevant information for operating the product on IT networks. The information refers to the firmware version and the instructions found in the previous chapters of this User Manual.

7.1 Installation Instructions

Install the device over the Web interface:

- Set up the basic device functions and protocol settings as described in Section 3.1.2.
- Disable the FTP, and Telnet servers in the IP port configuration as described in the LOYTEC Device User Manual [1].

Connect a serial console cable:

- Connect to the console as described in the LOYTEC Device User Manual [1].
- Go to menu [3] system configuration.
- Disable the Web server in option [9].
- Save the settings by hitting [x] for exit and save.

7.2 Firmware

The device is equipped with one piece of software. This is the firmware image and its related firmware version. The firmware is distributed as a downloadable file. The device can be upgraded by placing the firmware image onto the device using the procedure described in the LOYTEC Device User Manual [1].

7.3 Ports

This Section lists all ports, which may be used by the device. The ports are default settings for their respective services. If not stated otherwise, the ports can be changed.

Required Ports:

- 80 tcp: This port is opened by the Web server and the OPC XML-DA server. It can be disabled if OPC XML-DA is not required. The port can be changed.
- 1628 udp/tcp: This is the data exchange port for CEA-852 (LON over IP). It is required for the primary function of the device to exchange control network data between routers over the IP network. Each device needs this port open. The port can be changed.

- 47808 udp: This is the data exchange port for BACnet/IP. It is required for the primary function of the device to exchange control network data between routers over the IP network. Each device needs this port open. The port can be changed.

Optional ports not necessary for the primary product function. They can be disabled as described in the installation instructions in Section 7.1:

- 21 tcp: This port is opened by the FTP server. The port can be changed and disabled.
- 23 tcp: This port is opened by the Telnet server. The port can be changed and disabled.

7.4 Services

Required services:

- CEA-852 (LON over IP): Primary function of the device. This service is in accordance with the standard ANSI/CEA-852-B.
- BACnet/IP: Primary function of the device. This service is in accordance with the standard ANSI/ASHRAE 135-2010.
- OPC XML-DA: This Web service provides access to data points over the OPC XML-DA standard.

Optional services not necessary for the primary product function. They can be disabled as described in the installation instructions in Section 7.1:

- HTTP: Web server. It provides a Web-based configuration UI. The Web UI can be disabled after setting up the device.
- FTP and Telnet: The FTP and Telnet server is used for connection to the device by the Configurator for configuration, firmware upgrade, and access to the log file. On devices without SSH these services must be enabled during device configuration.

7.5 Logging and Auditing

The device contains a log file, which can be read out over FTP or the Web server. This log contains information when the device started and when crucial communication errors occur. Other information such user log-on are not logged as they are not part of the primary services of this device.

Logged events:

- Time of the last power-on reset of the L-DALI device.
- Time and version of the last firmware upgrade.
- Time when the device configuration has been cleared or the device was reset to factory defaults.
- Commission of the CEA-709 nodes.
- Static errors in the device and data point configuration.
- System overload situations as one-time log messages since last power-on.
- Crucial communication errors as they occur.

8 Specifications

8.1 Physical Specifications

8.1.1 LDALI-3E10X-U/LDALI-ME20X-U

Operating Voltage	85-240 V AC, 50/ 60 Hz
Power Consumption	typ. 7,5 W
Operating Temperature (ambient)	0°C to + 40°C
Storage Temperature	10°C to +85°C
Humidity (non condensing) operating	10 to 90% RH
Humidity (non condensing) storage	10 to 90% RH
Enclosure	Installation enclosure 9 TE, DIN 43 880
Environmental Protection	IP 40 (enclosure); IP 20 (screw terminals)
Installation	DIN rail mounting (EN 50 022) or wall mounting

8.1.2 LDALI-3E10X/LDALI-ME204

Operating Voltage	12-35 VDC or 12-24 VAC \pm 10%
Power Consumption	typ. 3 W
In rush current	up to 950 mA @ 24 VAC
Operating Temperature (ambient)	0°C to + 50°C
Storage Temperature	10°C to +85°C
Humidity (non condensing) operating	10 to 90% RH
Humidity (non condensing) storage	10 to 90% RH
Enclosure	Installation enclosure 9 TE, DIN 43 880
Environmental Protection	IP 40 (enclosure); IP 20 (screw terminals)

Installation DIN rail mounting (EN 50 022) or wall mounting

8.1.3 LDALI-3101-U/LDALI-E101-U/LDALI-E201-U

Operating Voltage 85-240 VAC 50/60 Hz

Power Consumption typ. 7.5 W

Operating Temperature (ambient) 0°C to + 40°C

Storage Temperature 10°C to +85°C

Humidity (non condensing) operating 10 to 90% RH

Humidity (non condensing) storage 10 to 90% RH

Enclosure Installation enclosure 6 TE, DIN 43 880

Environmental Protection IP 40 (enclosure); IP 20 (screw terminals)

Installation DIN rail mounting (EN 50 022) or wall mounting

8.2 Resource Limits

Table 33 and Table 34 specify the resource limits of the different L-DALI models.

Limits	Model						
	3E102	3E104	3101-U	E101-U	3E101-U	3E102-U	3E104-U
OPC Tags	2000	2000	-	2000	10000	10000	10000
User Registers	1000	1000	1000	1000	2000	2000	2000
Address table entries/legacy ¹	512/15	512/15	512/15	512/15	512/15	512/15	512/15
Alias NVs ¹	1000	1000	1000	1000	1000	1000	1000
LONMARK Calendar objects/patterns per object	2/10	4/10	1/10	1/10	4/10	4/10	4/10
LONMARK Scheduler objects	32	64	16	16	64	64	64
LONMARK Alarm Servers	2	4	1	1	4	4	4
Trend Logs	50	100	25	25	512	512	512
Total trended data points	256	256	256	256	1000	1000	1000
Total aggregated size	1MB	1MB	1MB	1MB	60MB	60MB	60MB
E-mail templates	100	100	100	100	100	100	100
Math objects	100	100	100	100	100	100	100
Alarm Logs	10	10	10	10	10	10	10
L-WEB Clients (concurrent)	8	8	-	8	32	32	32
Connections (local)	1000	1000	1000	1000	2000	2000	2000
Connections (global)	250	250	-	250	250	250	250

Table 33: Resource limits of different LDALI-10X models

¹ Per CEA-709 interface.

Limits \ Model	Model			
	ME204	E201-U	ME201-U	ME204-U
OPC Tags	2000	2000	10000	10000
User Registers	1000	1000	2000	2000
BACnet client mappings	1000	1000	1000	1000
BACnet scheduler objects	64	16	16	16
BACnet calendar objects	8	8	8	8
BACnet notification classes	16	4	4	4
Trend Logs	100	25	512	512
Total trended data points	256	256	1000	1000
Total aggregated size	1MB	1MB	60MB	60MB
E-mail templates	100	100	100	100
Math objects	100	100	100	100
Alarm Logs	10	10	10	10
L-WEB Clients (concurrent)	8	8	32	32
Connections (local)	1000	1000	2000	2000
Connections (global)	250	250	250	250

Table 34: Resource limits of different LDALI-20X models.

8.3 FCC Warning

This device has been tested and found to comply with limits for a Class B digital device, pursuant to Part 2 and 15 of FCC Rules. These limits are designed to provide reasonable protection against harmful interference when the equipment is operated in a commercial environment. This equipment generates and radiates radio frequency energy and, if not installed and used in accordance with the user's manual, it may cause interference in which case users will be required to correct interference at their own expenses.

8.4 CE Warning

This is a Class B product. In a domestic environment, this product may cause radio interference in which case the user may be required to take adequate measures.

9 References

- [1] LOYTEC Device User Manual 6.4, LOYTEC electronics GmbH, Document № 88086505, May 2018.
- [2] LINX Configurator User Manual 6.4, LOYTEC electronics GmbH, Document № 88086705, May 2018.
- [3] NIC User Manual 4.2, LOYTEC electronics GmbH, Document № 88067217, April 2013.
- [4] LWEB-802/803 User Manual 3.0, LOYTEC electronics GmbH, Document № 88074219, April 2018.
- [5] LWEB-900 User Manual 2.2, LOYTEC electronics GmbH, Document № 88081507, June 2017.
- [6] L-VIS User Manual 6.2, LOYTEC electronics GmbH, Document № 88068522, August 2017.
- [7] LIOB-10X/x5x User Manual 6.2, LOYTEC electronics GmbH, Document № 88078511, April 2017.
- [8] L-IP User Manual 6.1, LOYTEC electronics GmbH, Document № 88065912, October 2015.
- [9] LIP-ME20X User Manual 5.3, LOYTEC electronics GmbH, Document № 88073508, July 2015.
- [10] AN011E L-DALI Compatibility List, LOYTEC electronics GmbH, Document № 86002008, May 2018.

10 Revision History

Date	Version	Author	Description
07-05-2010	1.0	AD	Initial revision V1.0
15-06-2010	1.0.1	JB	Minor corrections
08-11-2010	1.1	JB	Updated for L-DALI firmware 2.1 and Configurator 1.1
16-09-2011	2.0	JB	Cover LDALI-ME20X (BACnet) firmware 2.2 Minor improvements related to LDALI-3E10X documentation
14-11-2011	2.0.1	JB	Minor corrections and improvements
29-06-2012	3.0	JB	Cover LDALI-3E10X firmware 3.0 and LDALI Configurator 3.0
07-09-2012	3.0.1	JB	Minor corrections
11-10-2013	3.1	JB	Cover LDALI-10X/20X firmware 3.1 and LDALI Configurator 3.1. Cover LDALI-E101-U, LDALI-3101-U and LDALI-E201-U.
13.08.2014	3.2	JB	Cover LDALI-10X/20X firmware 3.2 and LDALI Configurator 3.2. Cover LDALI-E101-U, LDALI-3101-U and LDALI-E201-U versions with Dual-Ethernet and internal DALI PS which can be switched off.
27.05.2015	5.2	JB	Cover LDALI-10X/20X firmware 5.2 and LINX Configurator 5.2 (replacing LDALI Configurator). Cover LDALI-MS1 and LDALI-BM1. Added more info on DALI basics and troubleshooting info. Added Property IDs for BACnet standard properties.
25.03.2016	6.0	JB	Re-organized User Manual structure, branched out common parts into LOYTEC Device User Manual and LINX Configurator User Manual. Cover LDALI-10X/20X firmware 6.0 and LINX Configurator 6.0. Cover LDALI-3E10X-U and LDALI-ME20X-U models.
21.09.2016	6.1	JB	Cover LDALI-10X/20X firmware 6.1.
31.10.2017	6.3	JB	Cover LDALI-10X/20X firmware 6.3.
21.05.2018	6.4	JB	Cover LDALI-10X/20X firmware 6.4. Added colour control via data points.