

# **PELCO**

by **Schneider** Electric

## **NET5501-I VIDEO ENCODER Installation/Operation Manual**



**Copyright**

All rights reserved. No part of this manual may be reproduced, distributed, or transmitted without the prior written permission of the manufacturer.

# Content

---

## OVERVIEW

4

- 4 Important Safety Instructions
- 5 Caution
- 6 Important Notices
- 8 Network Topology Statement
- 8 Legal Notice (Audio Notice)
- 8 Introduction
- 9 Package Contents
- 10 Front Panel Description
- 11 Rear Panel Description

## INSTALLATION

12

- 12 Wall Bracket Installation
- 13 Factory Default
- 14 Connecting to an External Device

## WEB VIEWER

18

- 18 What is the Web Viewer?
- 21 Live
- 23 System Setting
- 26 Network Setting
- 29 Camera Configuration
- 31 A/V Streams Setting
- 32 User Setting
- 34 Events Setting
- 35 Help

## APPENDIX

36

- 36 Product Specification
- 38 Troubleshooting (FAQ)
- 38 Pelco Troubleshooting Contact Information
- 39 Product Overview
- 40 Open Source License Report on the Product

# Overview

---

## IMPORTANT SAFETY INSTRUCTIONS

---

1. Read these instructions.
2. Keep these instructions.
3. Heed all warnings.
4. Follow all instructions.
5. Do not use this apparatus near water.
6. Clean only with dry cloth.
7. Do not block any ventilation openings. Install in accordance with the manufacturer's instructions.
8. Do not install near any heat sources such as radiators, heat registers, stoves, or other apparatus (including amplifiers) that produce heat.
9. Do not defeat the safety purpose of the polarized or grounding-type plug. A polarized plug has two blades with one wider than the other. A grounding plug has two blades and a third grounding prong. The wide blade or the third prong are provided for your safety. If the provided plug does not fit into your outlet consult an electrician for replacement of the obsolete outlet.
10. Protect the power cord from being walked on or pinched particularly at plugs, convenience receptacles, and the points where they exit from the apparatus.
11. Only use attachments/accessories specified by the manufacturer.
12. Use only with the cart, stand, tripod, bracket, or table specified by the manufacturer, or sold with the apparatus. When a cart is used, use caution when moving the cart/apparatus combination to avoid injury from tip-over.
13. Unplug this apparatus during lightning storms or when unused for long periods of time.
14. Refer all servicing to qualified service personnel. Servicing is required when the apparatus has been damaged in any way, such as power-supply cord or plug is damaged, liquid has been spilled or objects have fallen into the apparatus, the apparatus has been exposed to rain or moisture, does not operate normally, or has been dropped.
15. Apparatus shall not be exposed to dripping or splashing and that no objects filled with liquids, such as vases shall be placed on the apparatus.
16. **WARNING** : To reduce the risk of fire or electric shock, do not expose this apparatus to rain or moisture.
17. Installation should be done only by qualified personnel and conform to all local codes.
18. Unless the unit is specifically marked as a NEMA Type 3, 3R, 3S, 4, 4X, 6, or 6P enclosure, it is designed for indoor use only and it must not be installed where exposed to rain and moisture.
19. Use only installation methods and materials capable of supporting four times the maximum specified load.
20. A readily accessible disconnect device shall be incorporated in the building installation wiring.
21. A CCC approved power cord must be used to power this equipment when used in China.





## CAUTION

---



This symbol indicates that there are important operating and maintenance instructions in the literature accompanying this unit.



**WARNING :** This product is sensitive to Electrostatic Discharge (ESD). To avoid ESD damage to this product, use ESD safe practices during installation. Before touching, adjusting or handling this product, correctly attach an ESD wrist strap to your wrist and appropriately discharge your body and tools. For more information about ESD control and safe handling practices of electronics, please refer to ANSI/ESD S20.20-1999 or contact the Electrostatic Discharge Association ([www.esda.org](http://www.esda.org)).

# Overview

---

## IMPORTANT NOTICES

---

### REGULATORY NOTICES

This device complies with Part 15 of the FCC Rules. Operation is subject to the following two conditions: (1) this device may not cause harmful interference, and (2) this device must accept any interference received, including interference that may cause undesired operation.

### RADIO AND TELEVISION INTERFERENCE

This equipment has been tested and found to comply with the limits of a Class A digital device, pursuant to Part 15 of the FCC rules. These limits are designed to provide reasonable protection against harmful interference when the equipment is operated in a commercial environment. This equipment generates, uses, and can radiate radio frequency energy and, if not installed and used in accordance with the instruction manual, may cause harmful interference to radio communications. Operation of this equipment in a residential area is likely to cause harmful interference in which case the user will be required to correct the interference at his own expense.

Changes and Modifications not expressly approved by the manufacturer or registrant of this equipment can void your authority to operate this equipment under Federal Communications Commission's rules.

### CAN ICES-3(A)/NMB-3(A)

### LEGAL NOTICE [Audio Notice]

SOME PELCO EQUIPMENT CONTAINS, AND THE SOFTWARE ENABLES, AUDIO/VISUAL AND RECORDING CAPABILITIES, THE IMPROPER USE OF WHICH MAY SUBJECT YOU TO CIVIL AND CRIMINAL PENALTIES. APPLICABLE LAWS REGARDING THE USE OF SUCH CAPABILITIES VARY BETWEEN JURISDICTIONS AND MAY REQUIRE, AMONG OTHER THINGS, EXPRESS WRITTEN CONSENT FROM RECORDED SUBJECTS. YOU ARE SOLELY RESPONSIBLE FOR INSURING STRICT COMPLIANCE WITH SUCH LAWS AND FOR STRICT ADHERENCE TO ANY/ALL RIGHTS OF PRIVACY AND PERSONALTY. USE OF THIS EQUIPMENT AND/OR SOFTWARE FOR ILLEGAL SURVEILLANCE OR MONITORING SHALL BE DEEMED UNAUTHORIZED USE IN VIOLATION OF THE END USER SOFTWARE AGREEMENT AND RESULT IN THE IMMEDIATE TERMINATION OF YOUR LICENSE RIGHTS THEREUNDER.

### VIDEO QUALITY CAUTION

#### FRAME RATE NOTICE REGARDING USER SELECTED OPTIONS

Pelco systems are capable of providing high quality video for both live viewing and playback. However, the systems can be used in lower quality modes, which can degrade picture quality, to allow for a slower rate of data transfer and to reduce the amount of video data stored. The picture quality can be degraded by either lowering the resolution, reducing the picture rate, or both. A picture degraded by having a reduced resolution may result in an image that is less clear or even indiscernible. A picture degraded by reducing the picture rate has fewer frames per second, which can result in images that appear to jump or move more quickly than normal during playback. Lower frame rates may result in a key event not being recorded by the system.

Judgment as to the suitability of the products for users' purposes is solely the users' responsibility. Users shall determine the suitability of the products for their own intended application, picture rate and picture quality. In the event users intend to use the video for evidentiary purposes in a judicial proceeding or otherwise, users should consult with their attorney regarding any particular requirements for such use.

## OPEN SOURCE SOFTWARE

This product includes certain open source or other software originated from third parties that is subject to the GNU General Public License (GPL), GNU Library/Lesser General Public License (LGPL) and different and/or additional copyright licenses, disclaimers, and notices.

The exact terms of GPL, LGPL, and some other licenses are provided to you with this product. Please refer to the exact terms of the GPL and LGPL at <http://www.fsf.org> (Free Software Foundation) or <http://www.opensource.org> (Open Source Initiative) regarding your rights under said license. You may obtain a complete corresponding machine-readable copy of the source code of such software under the GPL or LGPL by sending your request to [digitalsupport@pelco.com](mailto:digitalsupport@pelco.com); the subject line should read Source Code Request. You will then receive an email with a link for you to download the source code.

This offer is valid for a period of three (3) years from the date of the distribution of this product by Pelco.

## CCC POWER CORD STATEMENT

Models shipped to China do not include power cords.

**Note** : A CCC approved power cord must be used to power the equipment when used in China.

## Korean Class A EMC

이 기기는 업무용 (A급) 전자파 적합기기로서 판매자 또는 사용자는 이 점을 주의하시길 바라며, 가정 외의 지역에서 사용하는 것을 목적으로 합니다.

This is a Class A product. In a domestic environment this product may cause radio interference in which case the user may be required to take adequate measures.

## ESD WARNING



**WARNING:** This product is sensitive to Electrostatic Discharge (ESD). To avoid ESD damage to this product, use ESD safe practices during installation. Before touching, adjusting or handling this product, correctly attach an ESD wrist strap to your wrist and appropriately discharge your body and tools. For more information about ESD control and safe handling practices of electronics, please refer to ANSI/ESD S20.20-1999 or contact the Electrostatic Discharge Association ([www.esda.org](http://www.esda.org)).

## Warranty

For information about Pelco's product warranty and thereto related information, refer to [www.pelco.com/warranty](http://www.pelco.com/warranty).

# Overview

---

## NETWORK TOPOLOGY STATEMENT

---

**IMPORTANT NOTE. PLEASE READ.** The network implementation is shown as a general representation only and is not intended to show a detailed network topology. Your actual network will differ, requiring changes or perhaps additional network equipment to accommodate the system as illustrated. Please contact your local Pelco representative to discuss your specific requirements.

## LEGAL NOTICE (AUDIO NOTICE)

---

**!** Improper use of audio/visual recording equipment may subject you to civil and criminal penalties. Applicable laws regarding the use of such capabilities vary between jurisdictions and may require, among other things, express written consent from the recorded subjects. You are solely responsible for insuring strict compliance with such laws and for strict adherence to any/all right of privacy and personalty.

## INTRODUCTION

---

The NET5501-I video encoder is a network-based channel encoder with a built-in, Web-based viewer for live streaming to a standard Web browser (Microsoft® Internet Explorer®, Chrome®, Safari® or Mozilla® Firefox®). The encoder is built upon open standards and is part of an Endura® system for recording, managing, administering, and viewing video streams.

The encoder supports H.264 and MJPEG compression. It can generate two independently configurable H.264 streams, each up to D1 resolution (720 x 480 for NTSC, 720 x 576 for PAL) and 30/25 images per second (ips) in addition to an MJPEG stream for Web viewing.

The NET5501-I can be configured for one video channel. When an alarm event is triggered, the unit can send a message to an operator.

The unit also supports motion detection for the video channel. You can configure one motion zone, with its own independent sensitivity and threshold settings. When the NET5501-I detects activity in any of these areas, it can trigger an alarm event.

The NET5501-I supports control of remote peripherals such as pan/tilt/zoom (PTZ) cameras by way of D-Protocol, P-Protocol, and Coaxitron® protocols.

## FEATURES

- Open standards-based architecture
- H.264 baseline, main, or high profile compression
- Dual-stream at up to D1, 30/25 images per second (ips) per stream
- Integrated D-Protocol, P-Protocol, and Coaxitron protocols
- Support for multicast transmissions

# PACKAGE CONTENTS

---

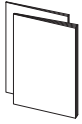

Installation Manual, Safety Instruction  
(2ea)

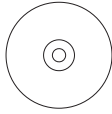

Resource Disc



4-Pin Terminal Block (1ea)



Screw (4ea) for Wall bracket binding 2  
plus 2 spare

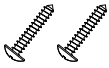

Screw (2ea) for Wall mounting



Anchor (2ea) for Wall mounting

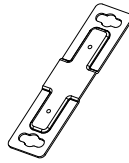





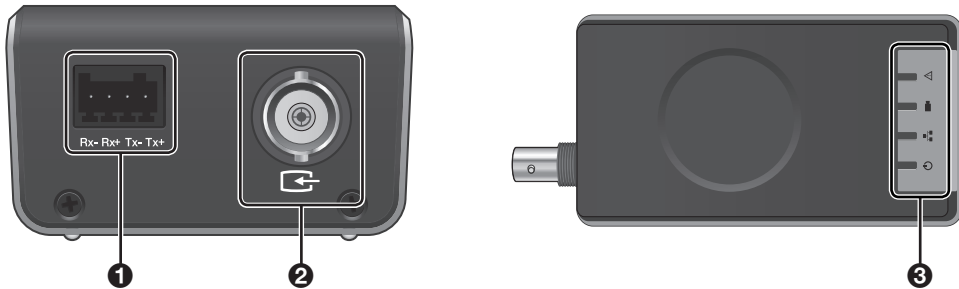

Wall Mount Bracket (1ea)

# Overview

## FRONT PANEL DESCRIPTION





No.	Name	Description
1	RX+/RX-	RS-422 RX Data line <b>!</b> Disabled in RS-485 mode.
	TX+/TX-	RS-422/RS-485 Data line
2		Video input BNC terminal.
3	Top Panel Indicators	 Displays power On/Off status. It glows blue when the unit has power.
		 Displays network status (connection and speed). <b>Off</b> : The unit is not connected to the network. <b>Solid amber</b> : The unit is connected to the network using the 100 Mbps standard. <b>Solid red</b> : The unit is connected to the network using the 10 Mbps standard. <b>Solid green</b> : The unit is connected to the network using the 1 Gbps standard.
		 A blinking light indicates network activity corresponding to the speed based on the color.
		 Displays camera connection status. <b>Not Lit</b> : A camera has not been connected yet. <b>Green</b> : Camera video is present at the video in connector. <b>Red</b> : Video is no longer present, the camera is not functioning properly.
		 Displays unit status. <b>Green</b> : The unit is functioning normally. <b>Red</b> : The unit is in an error condition.

## PTZ Pin Assignments

Label	Lead	Label	Lead
RX-	RS-422 Data RX-	TX-	RS-422 Data TX-
RX+	RS-422 Data RX+	TX+	RS-422 Data TX+

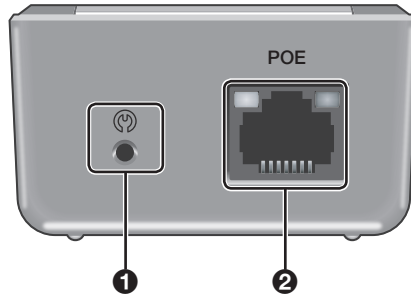
## REAR PANEL DESCRIPTION



No.	Name	Description
1		Press this switch to reset device to the factory default. If you perform the factory reset, all your settings to device will be lost. For more information, please see Factory Default (Page 13).
2	PoE	Connects to the network and supplies power through Ethernet cable.

# Installation

---

## WALL BRACKET INSTALLATION

---

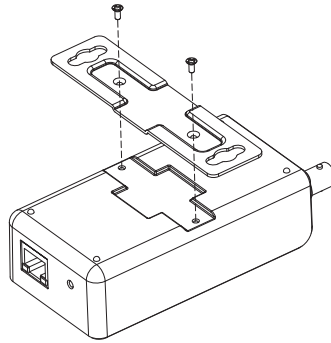

7. Align the product with the bracket holes. Insert and tighten the provided screws to attach the product to the bracket.

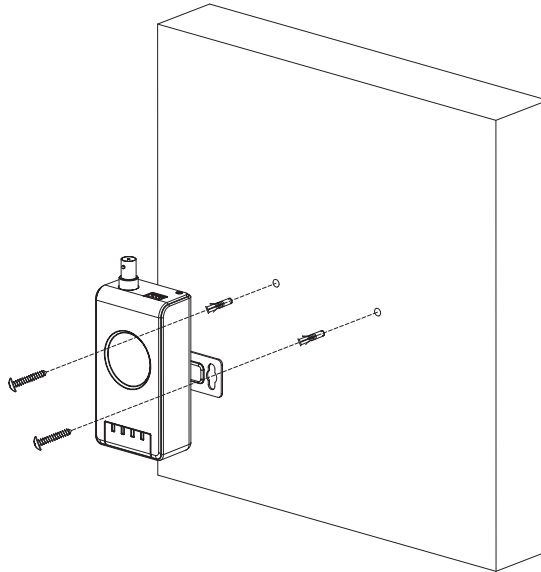



2. Use drill bit of 5 mm (0.20 in.) diameter and drill on the marked positions, drill to have 3 cm (1.18 in.) deep holes. Clean the holes after drilling.
  3. Insert an anchor for each hole. Fully insert anchors by lightly hammering the anchor head with a hammer/rubber hammer.
  4. Place the wall-mount bracket on the desired wall and fasten screws through the 2 holes using a screwdriver.
- !** Use the provided screws when installing the bracket on the product. If you use any other screws, it may cause damage to the product.

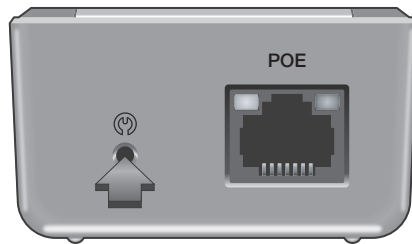

## FACTORY DEFAULT

---



1. Press and hold the Reset switch with a pointed object such as a paper clip before powering on.
2. Power on.
3. Release the Reset switch when the power LED [  ] on the top panel is turned on. (about 8 seconds).
4. When the encoder reset is completed, the system will restart by the factory default.

# Installation

## CONNECTING TO AN EXTERNAL DEVICE

### Connecting the Video

Connect the [  ] port of the encoder to the video output port of the camera.

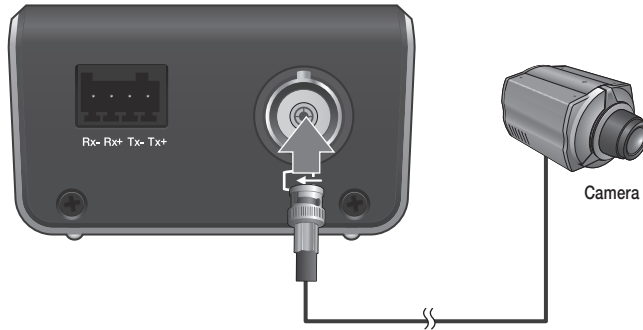

### Connecting the terminal block

The terminal block has tension clamps instead of screw terminals. Use a small screwdriver to open the clamp for a particular lead.

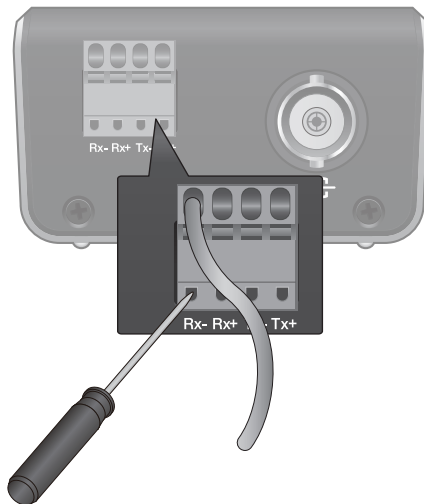

## Connecting the RS-422/RS-485 Device

Connect the external device to the [RS-422/RS-485 Data line] ports.  
You can connect and control PTZ camera that supports RS-422/RS-485 communication.

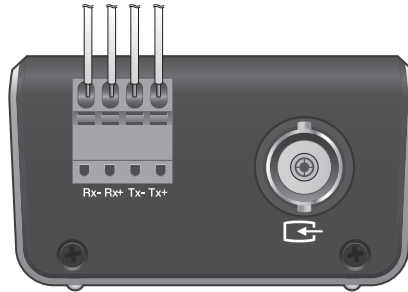

# Installation

## Network Connection

### PC Connection in the Local Network

You can connect the encoder to a PC in the same network and control or manipulate it on the PC monitor.

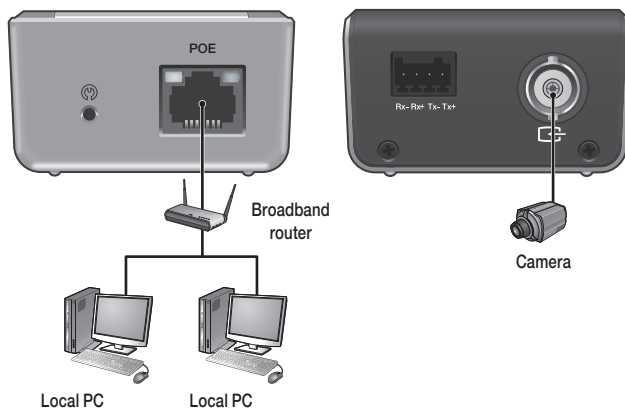

1. Connect the network port in the rear panel to the router or hub.

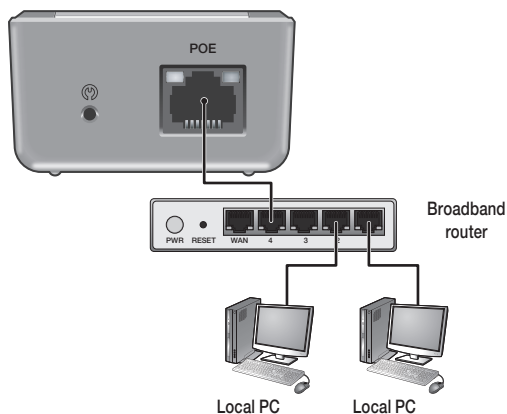

2. Connect the local PC to the router or hub.
3. Enter the address in the address bar (web browser) of the local PC or of the dedicated software program in the format of **"http://IP address:web service port"**.  
(Ex : http://192.168.0.23:80) From the Network Setup screen, you can change the port number.
  - ✓ If you do not know the camera's IP address, you can locate it using the Pelco Device Utility Software.
4. Provide the ID and password before logging in. Then, you can view the monitoring screen.  
Access ID (factory default) : admin, P/W : admin.
  - ! For security purposes, change the password right after you purchase the product.

## PC Connection From a Remote Network

You can connect the encoder to a PC or mobile device in the same remote network and control or manipulate it on the monitor of the PC or mobile device

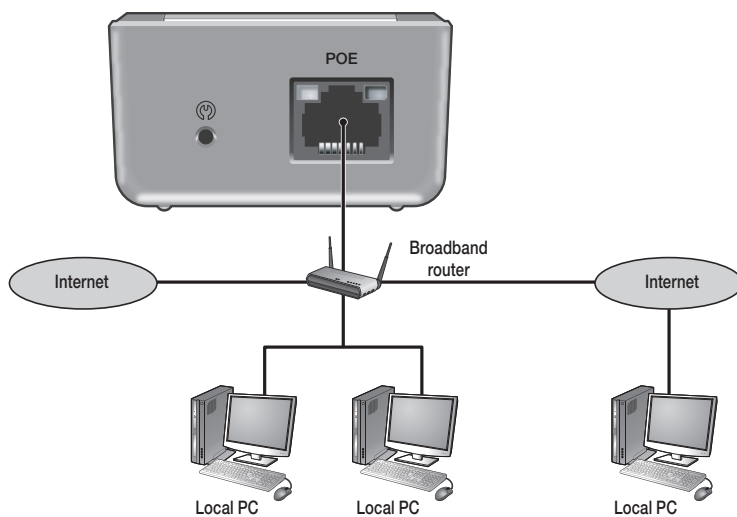

1. Connect the network port in the rear panel to the router.

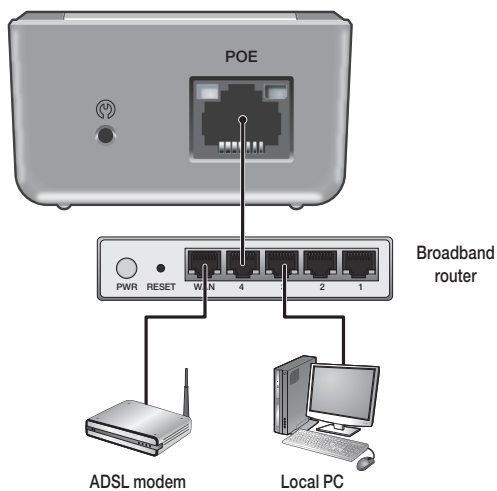

2. Connect the [NETWORK] port of the router directly to the fixed IP LAN cable, or connect it to the ADSL modem.

# Web Viewer

---

## WHAT IS THE WEB VIEWER?

---

### Minimum PC Requirement

CPU	P4 3.0 or Higher
RAM	512MB or Higher
VGA	GeForce MS 400, Radeon 7500 or higher GeForce 8 series or higher
VGA MEMORY	64MB
MONITOR	1280 X 1024
BROWSER	Internet Explorer, Firefox, Chrome, Safari
IE VERSION	IE8.0 or higher
NETWORK	10/100 Bps

### Accessing the Encoder and Attached Cameras

The first time you access the camera, the live video page appears. By default, you are viewing the video as a public user and only have access to the single stream live view.

If, for security purposes, users should not be allowed to view video without first logging on to the camera, change the permissions for public users.

## Pelco Media Player Installation

To view videos after accessing the Web viewer, the Pelco Media Player plug-in must be installed. Install Pelco Media Player from the CD included with the player.

- ✓ The Pelco Media Player 1.9.5 or higher is required for multiple channels.

1. Run InstallPelcoMediaPlayer.msi.
2. Click the **[Next>]** button to start installation.

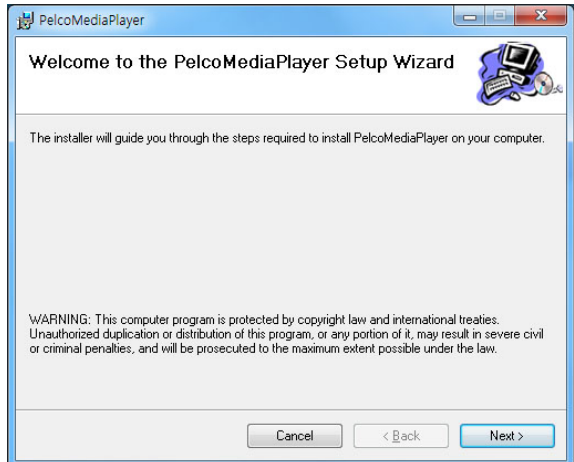

3. Click the **[Close]** button.  
Pelco Media Player Installation is complete.

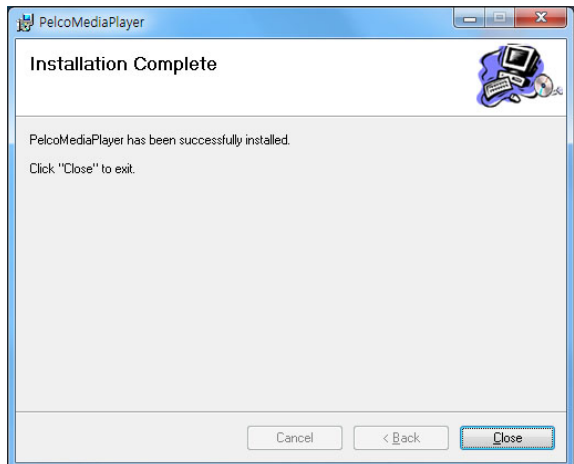

# Web Viewer

## Logging In

Entering the IP address of the camera as a URL into the web browser will immediately bring up the Live Mode screen if the encoder is not setup to require authentication (Open Authentication option).

If the camera is setup to require authentication, then the user will be prompted for a Username and Password before being able to see the live video feed.

1. Click <Login> on the live screen.

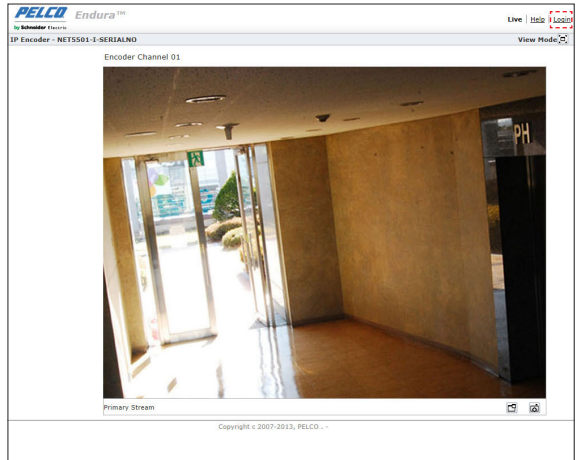

2. Enter your <Username> and <Password>.

✓ Default username : admin, Password : admin

3. Click the <Login> button.

✓ The Open Authentication option is configured on the Settings > Users > General Settings screen.

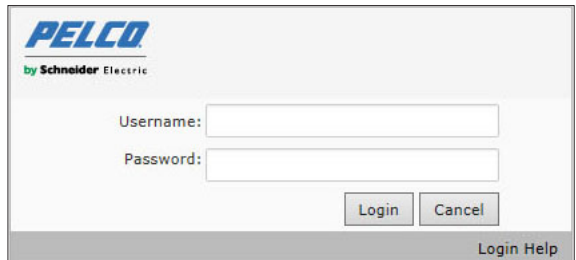

## Change Your Password

Please change the password for your security.

1. Click <admin> from the live screen.

2. Enter your new password.

3. Click the <Save> button.

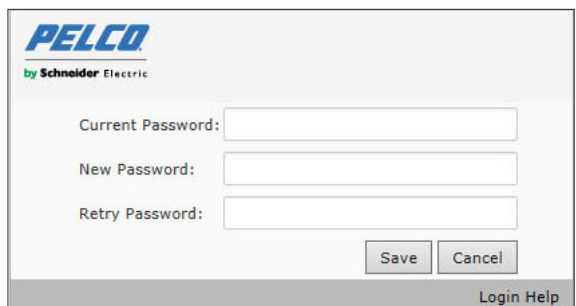



## Live Screen Overview

Live Mode Screen Components



No.	Name	Description
1	Channel Name	Displays the name assigned to the channel selected.
2	Multi-Function Image Button	▲ Tilt Up
		▼ Tilt Down
		▶ Pan Right
		◀ Pan Left
		🏠 Home Preset
3	Control the Zoom	[-] [Q] [+] Activates Zoom in (-) / Zoom out (+) features.
4	Control the Focus	[-] [E] [+] Activates Near (-) / Far (+) features.
5	Control the Iris	[-] [R] [+] Adjusts the camera brightness.
6	Move to Presets	Moves to the preset selected.
7	Pattern	Activates the pattern selected.

# Web Viewer

No.	Name	Description
8	Stream Selection	Selects the viewable video stream that displays in live view (Primary, Secondary, QuickView) and selects unicast or multicast and throttle settings. ✓ It will not be presented to users who are designated as Viewers.
9	View the Selected Tab	Composed of Live, Settings, Help, and Logout settings menus.
10	Maximize Viewing Area	Scales the image to the full size of the browser. To resize the video pane to normal view, click the Show Toolbar button in the upper-right corner of the window.
11	Take a Snapshot	Captures the image displayed in the video pane and saves it as a JPEG file.
12	Open Stream in New Window	Opens the video in a scalable, independent window. Opening the video in a separate window allows you to view the video while other applications are running. This window can be minimized, maximized, or closed using the title bar buttons of the active window. The window can also be resized by dragging a corner of the window.
13	Pan/Tilt/Zoom	Control the encoder and the pan (left/right) and tilt (up/down) of the connected camera by dragging the mouse. Also, zoom using the scroll wheel on the mouse. ✓ These icons are always available when using the Pelco Media Player. If you are using QuickTime®, PTZ overlay is only available with PMP player.

## Selecting a Stream

1. Click  from the live screen. Move to the Stream settings screen.

2. Select one of the following streams.

- Primary STREAM : To select this stream, click the button next to Primary Stream.
- Secondary STREAM : To select this stream, click the button next to Secondary Stream.
- QuickView STREAM : To select this stream, click the button next to QuickView Stream.  
 ✓ If the secondary stream has not been configured, only Primary Stream, and QuickView Stream are available.

3. Select the transmission.

- Unicast : A unicast transmission sends a separate video stream to each user that is requesting data. Although multiple users might request the same data from the encoder at the same time, duplicate video streams are transmitted to each user. Every unicast user that connects to the encoder consumes additional processing power, which limits the number of simultaneous users who can access the camera.
- Multicast : A multicast transmission sends data to multiple users at the same time using one transmission stream. Each multicast user that connects to the camera consumes no additional processing power; therefore, multicast video streams can be sent to an unlimited number of simultaneous users. The multicast transmission setting is available in the primary and secondary stream display settings.

4. Select the Player.

5. Click the **<Select>** button.

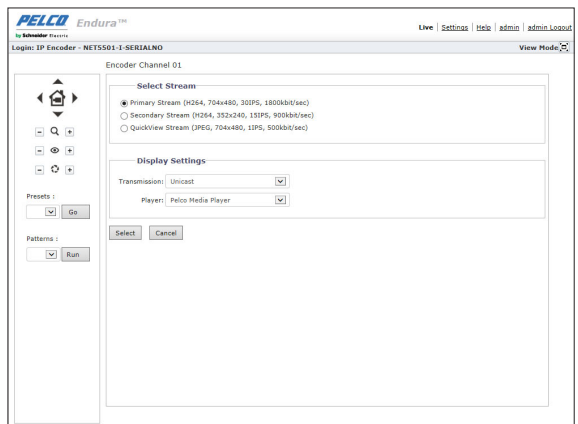

# SYSTEM SETTING

## General Settings

Modify the system default settings of the encoder.

### General Settings

- Device Name : Set the name to use for the encoder.
  - ✓ The device name must be at least two (2) characters and no more than 63 characters.

### Time Settings

- Time Server : Set the time to apply to the encoder.
  - None : Specify no time setting for the encoder.
  - DHCP : Specify the time from the DHCP server.
  - Manual : Select whether the encoder is to be set to the domain of the IP address or NTP server.
- Time Zone : Set the time zone relative to standard time (GMT).
- Current Date : Display the date and time set.

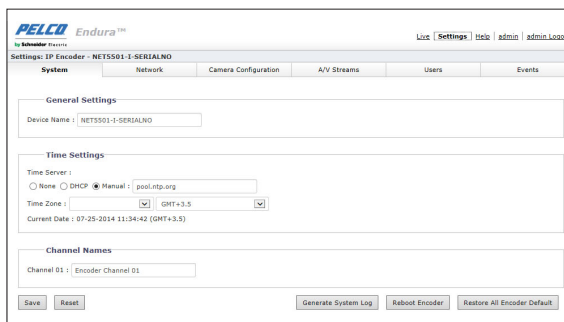

### Channel Names

One input field for the channel on the encoder to allow specification of channel / camera name.

### Generate System Log

It will create a system log file that can be used by Pelco Product Support for troubleshooting. The System Log file will be automatically downloaded using the web browser. The user will not be prompted for a file name. The downloaded file will be a tar compressed file with a file extension of .tgz. The file name will be comprised of the characters “\_log” appended to the encoder serial number.

### Reboot Encoder

Restart the encoder.

### Restore All Encoder Defaults

All settings will be restored to the factory default settings.

# Web Viewer

## Analog Input

You can set the type of the encoder analog video output.

## Analog Video Input Standard

Set the video output type.

- Auto : Automatic conversion according to the video input type connected.
- NTSC : Select to force the video mode if the transfer method supports NTSC.
- PAL : Select to force the video mode if the transfer method supports PAL.

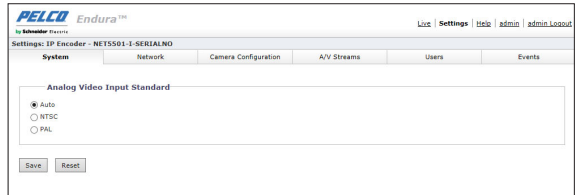

## Backup & Restore

You can backup or restore settings. The system will restart automatically after backup or restoration.

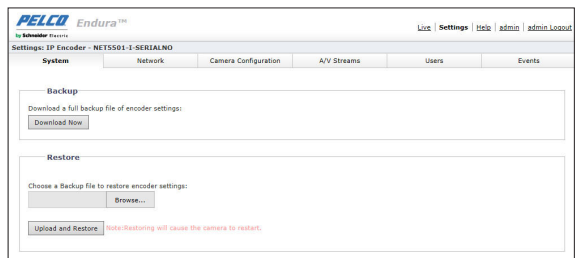

## Backup Current Settings

1. Click the [Download Now] button. The File path setting window will appear.

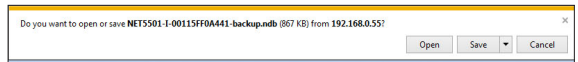

2. Select the backup path, enter a name, and then click the [Save] button. Information about the current settings will be saved in ".ndb" file format in the designated location.

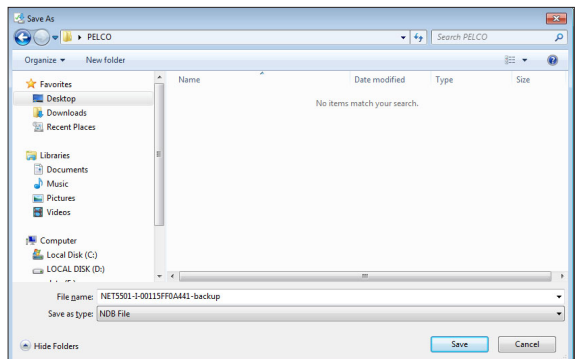

## Restore Backup Settings

1. Click the **[Browse...]** button to restore backup settings.
2. Select the desired backup file and click the **[Open]** button.
3. Click the **[Upload and Restore]** button.

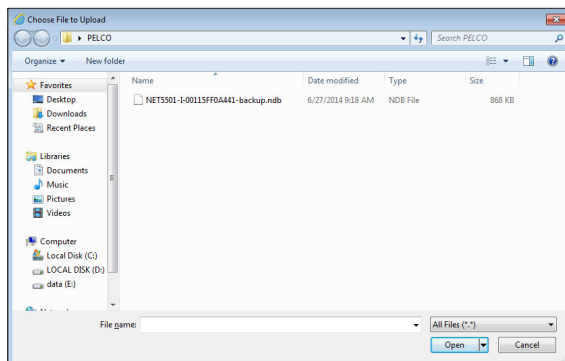

## Information

Check the encoder's system information.

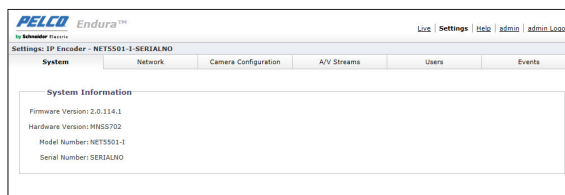

## Firmware

You can upgrade the encoder's firmware.

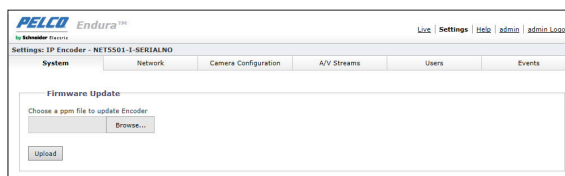

# Web Viewer

## NETWORK SETTING

### General

Modify the network default settings of the encoder.

### System Settings

Set the system hostname and port.

- **Hardware Address** : Presents the MAC Address of the encoder device.
- **Hostname** : A user-friendly name into the Hostname box (1 to 21 characters) using alphanumeric characters should be specified.  
A user-friendly name makes it easier to recognize the device on the network. Numeric-only names are not allowed.
- **HTTP Port** : The HTTP port used to access the encoder from a web browser. Default value is 80 (TCP).
- **HTTPS Port** : Security enhanced version of the web communication protocol, HTTP.  
Used to set HTTPS mode in SSL; the default value is 443 (TCP).
- **RTSP Port** : Port number used to support remote connection to the encoder from the client software.

The screenshot shows the 'Settings: IP Encoder - NET5501-0-SERIALNO' page. The 'Network' tab is selected. Under 'System Settings', the 'Hardware Address' is 00:11:3F:7D:A4:43. The 'Hostname' is NET5501-0-SERIALNO. The 'HTTP Port' is 80, 'HTTPS Port' is 443, and 'RTSP Port' is 554. Under 'IPv4 Settings', 'DHCP' is turned 'On'. The 'IP Address' is 192.168.0.55, 'Subnet Mask' is 255.255.255.0, 'Gateway' is 192.168.0.1, 'Primary DNS' is 168.126.63.1, and 'Secondary DNS' is 168.126.63.2. 'Save' and 'Reset' buttons are at the bottom.

### IPv4 Settings

Set the IPv4 of the encoder.

- **IP Address** : Displays the currently set IP address.
- **Subnet Mask** : Displays the IP address set for the <Subnet Mask>.
- **Gateway** : Displays the IP address set for the <Gateway>.
- **Primary DNS/Secondary DNS** : Sets a valid IP address for the DNS server.  
Settable when DHCP is not selected.

## SSL

You can either select the security access method for the encoder or install an accreditation certificate.

### SSL Configuration

Select a security access method.

#### Certificate

Install an accreditation certificate.

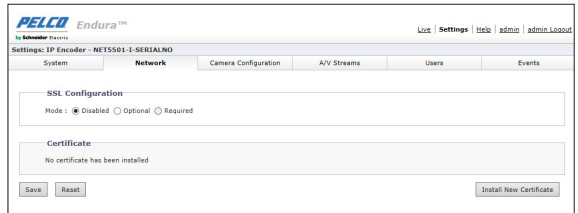

### To Install an Accreditation Certificate

1. Click <Install New Certificate>.
2. Select a certificate to install.
3. Click <Next>.
4. Select the accreditation certificate and key file to install.
5. Click the <Generate Certificate> button.

- ✓ To delete the accreditation certificate installed, select the certificate and click <Delete Certificate>.

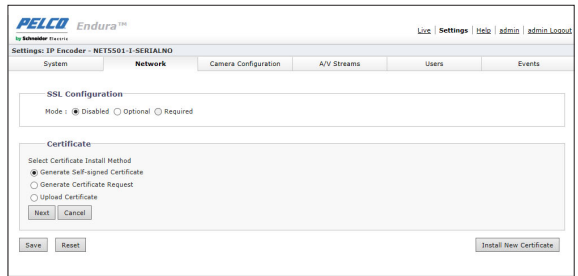

## SSH

The SSH settings page enables or disables SSH access to the camera. SSH is a user-enabled protocol that allows Pelco Product Support to log onto and service the camera for advanced troubleshooting purposes. From the SSH settings page, users with the appropriate permissions can enable or disable SSH access to the camera.

### SSH Settings

Set SSH accessibility on the encoder.

- Username : This attribute has a fixed value of "root" and cannot be changed.
- Password : SSH Password must be between 4 and 64 characters.
- Re-type Password : Enter your password again.

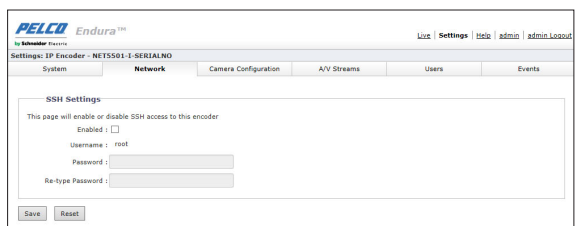

# Web Viewer

## 802.1x

When connected to a network, select 802.1x protocol to install the certificate.

### 802.1x Port Security

- Protocol : Specify the 802.1x protocol.
- Username : Enter the client certificate ID.
- Password : Enter the certificate key password. If the key file used is not encrypted, you don't need to enter it.

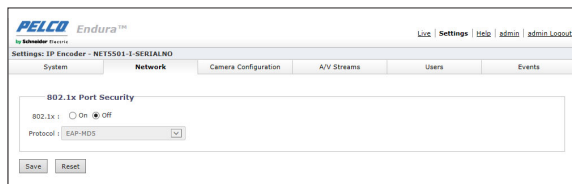

## SNMP

The system or network manager can use the SNMP protocol to monitor network equipment or operate environment settings and other tasks remotely.

### SNMP Configuration

- SNMP v2c : Use SNMP version 2.
- SNMP V3 : Use SNMP version 3.

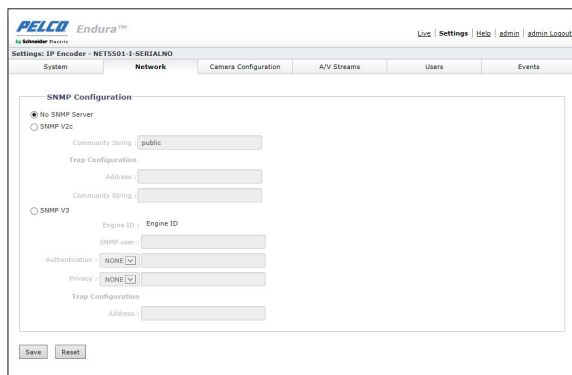



# CAMERA CONFIGURATION

Choose number 1 to the number of channels on the encoder.

## General

Setup the camera connected to the encoder.

## Digital Processing

Adjust each camera channel video input.

- Saturation Adjust : Adjust video saturation.
  - Contrast Adjust : Adjust video contrast.
  - Brightness Adjust : Adjust video brightness.
  - Hue Adjust : Adjust video tint.
- ✓ Click **<Restore Settings to Defaults>** to restore the factory settings.

## Live Preview

Check videos of the selected video channel.

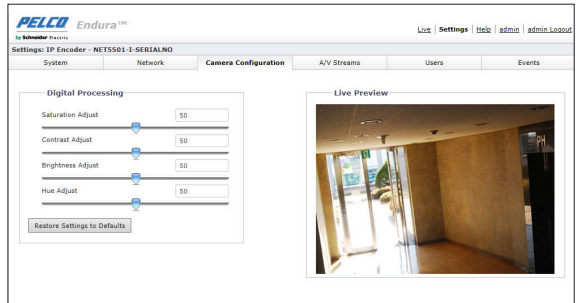

## OSD

Use the arrow keys on your keyboard to navigate through the menus then press the Enter key to make your selection.

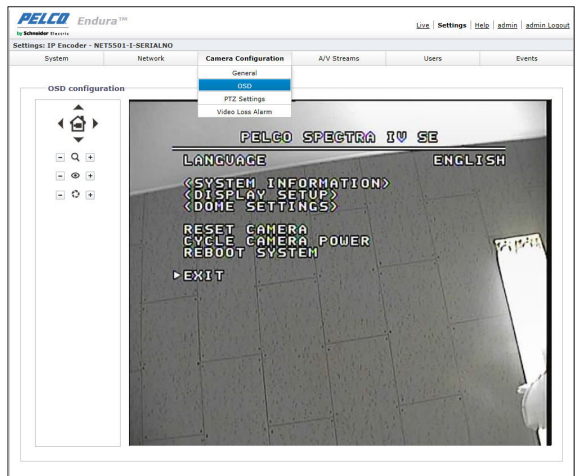

# Web Viewer

## Configuration and operation for presets and patterns

Patterns and presets can be configured directly from the OSD for third-party cameras that support these features.

1. Access the OSD from the Settings page.
2. Using the arrow keys select Dome Settings, and then press the Enter key.
3. Using the arrow keys select Presets or Patterns, and then press the Enter key.
4. Proceed to program presets and patterns. Refer to the Installation/Operation manual for the appropriate Product from Camera Solutions.

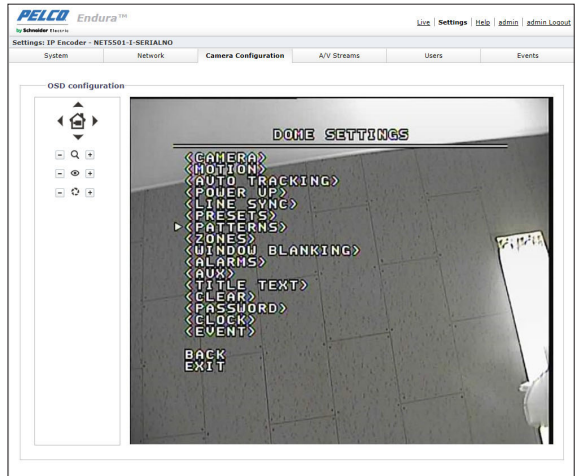

## PTZ Settings

Set up each camera's PTZ settings.

- Protocol : Select a supported PTZ protocol.
- Address : Enter the D or P protocol address of the connected PTZ.
- Baud Rate : Select the transfer speed of the connected PTZ.

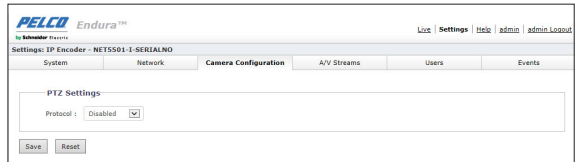

## Video Loss Alarm

Set whether to activate the alarm if video is no longer present. The camera is not functioning properly.

### Delay before alarm

Set the period of video loss, in seconds, that will trigger a video loss alarm.



# AV STREAMS SETTING

## Video Configuration

Set the video streaming of the channel connected to the encoder.

### Select Preset

Select a preset for seamless streaming.

### Primary Stream/Secondary Stream

Select **<Custom>** as preset to set up detailed settings

✔ Click **<Show All Configurations>** to check the current video streaming information.

The screenshot displays the 'A/V Streams' configuration page in the PELCO Endura web interface. The page is titled 'Settings: IP Encoder - NET5501-1-SERIALNO' and includes navigation tabs for System, Network, Camera Configuration, A/V Streams, Users, and Events. The 'A/V Streams' tab is active, showing the 'Video Stream Configuration' section.

**Select Preset**

Presets are fully-configured video configurations that offer a good balance of video performance to bandwidth. These presets may also be used as a starting point for a custom configuration.

- High | Primary Stream H264, 30FPS, 704x480, 1,800 kbit/sec | Secondary Stream H264, 15FPS, 352x240, 900 kbit/sec
- Medium | Primary Stream H264, 30FPS, 704x480, 1,100 kbit/sec | Secondary Stream H264, 15FPS, 352x240, 700 kbit/sec
- Low | Primary Stream H264, 15FPS, 352x240, 650 kbit/sec | Secondary Stream H264, 15FPS, 352x240, 700 kbit/sec
- Custom | User specified settings for Primary and Secondary Streams

**Primary Stream**

H264, 30 FPS, 704x480, 1800 kbit/sec, Baseline

Name: Primary Stream | QoS (DSCP) Codepoint: 34 | Clear

Compression Standard: H264 | Endura Signing:  (Lower framerate possible when Endura Signing ON)

Resolution: 704x480 | Profile: Baseline

Image Rate: 30 | Bit Rate (kbit/sec): 1800

I-frame Interval: 30

**Secondary Stream**

H264, 15 FPS, 352x240, 900 kbit/sec, Baseline

Name: Secondary Stream | QoS (DSCP) Codepoint: 34 | Clear

Compression Standard: H264 | Endura Signing:  (Lower framerate possible when Endura Signing ON)

Resolution: 352x240 | Profile: Baseline

Image Rate: 15 | Bit Rate (kbit/sec): 900

I-frame Interval: 15

Buttons: Save, Reset

# Web Viewer

## USER SETTING

### General Settings

Set up user authentication mode and local/remote information.

### Authentication Mode

Set public/private settings of the authentication mode.

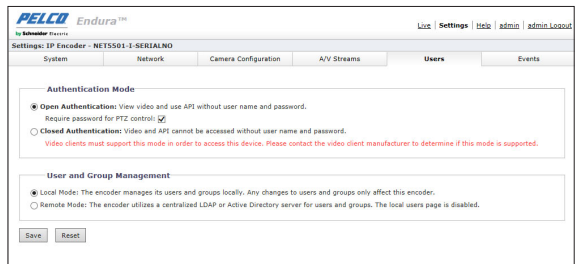

### User and Group Management

- Local Mode : The default setting is local mode. Any changes to users and groups affect only the camera that you are accessing.
- Remote Mode : Set remote mode for users connected through LDAP or the Active Directory server.
- LDAP Server : Specify the IP address or hostname of the LDAP server.
- LDAP Port : Specify the port over which the encoder will communicate with the LDAP server. The default port for LDAP Communications is 389.
- Base DN : Type the distinguished name (DN) that is the basis for LDAP searches.
- Bind DN Template : Provide the template to format the username (provided when the user logs on to the encoder) for searches in the LDAP .
- Search Template : Provide the LDAP search query for users found in the Base DN. The search must match an entry in the LDAP user record to the bind name (username).
- Admins : Remote server Group Mapping value to be used for Admin designated users.
- Managers : Remote server Group Mapping value to be used for Manager designated users.
- Operators : Remote server Group Mapping value to be used for Operator designated users.
- Viewers : Remote server Group Mapping value to be used for Viewer designated users.
- User : Input the username credential of a user who can be authenticated through the LDAP server.
- Password : LDAP Server password.

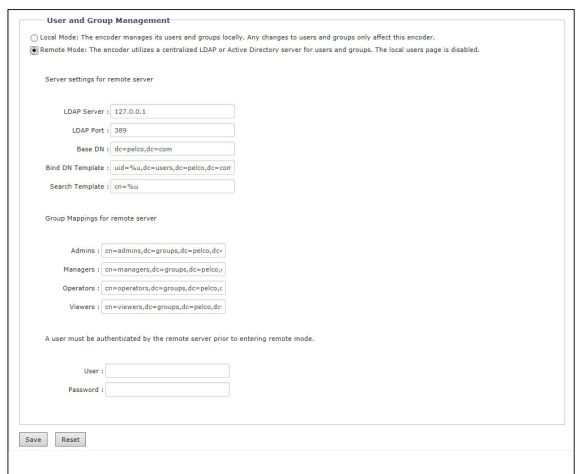

## Users

Set up settings relating to user management and rights.

### To Add a User Account

1. At the bottom left screen click the **<New User>** button.
2. Select **<New User>**.
  - Access Level : Set the rights for the account.
    - Admins : Permissions include access to all camera settings.
    - Managers : Permissions include access to all settings except this user cannot modify user permissions or restore factory default settings.
    - Operators : Permissions include view video, use PTZ functions, and use the API.
    - Viewers : Permissions include view video and use the API.
  - Username : Specify the user name.
  - Password : Specify the password.

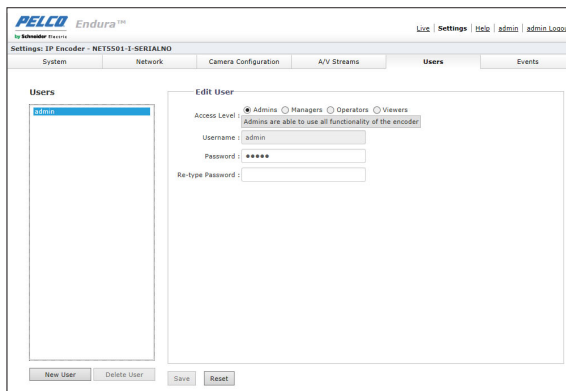

### To Change User Account Information

1. Select from the user list the username to be changed.
2. Modify the desired fields and click **<Save>**.

### To Delete a User Account

1. Select from the user list the username to be deleted.
2. Click **<Delete User>**.

# Web Viewer

## EVENTS SETTING

### Motion Detection

You can select the event signal to be given if a movement is detected.

#### To Set Motion Detection

1. Select Video Channel and Sensitivity.
2. Drag the mouse over the Live Preview screen and set the motion detection area.
  - Select All : Select all areas.
  - Deselect All : Deselect all areas.

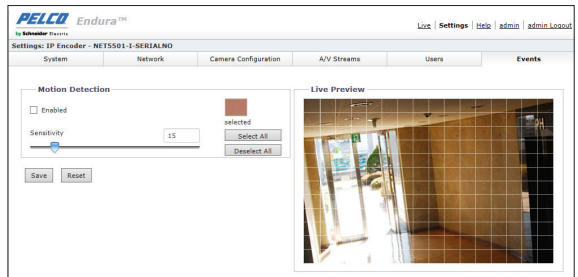

### Sabotage Detection

You can select the event signal to go off when tampering with a camera (covering the lens, change in camera position, etc.) is detected.

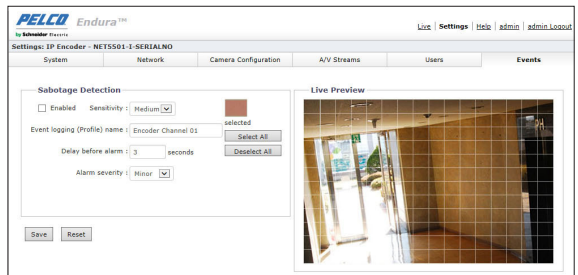

# SMTP Notification Handler

A message will be sent to the e-mail address registered in the SMTP server when an alarm is set off.

The screenshot shows the 'SMTP Notification Handler' configuration page in the Pelco Endura web interface. The page is titled 'Settings: IP Encoder - NET5501-1-SERIALNO' and includes navigation tabs for 'System', 'Network', 'Camera Configuration', 'A/V Streams', 'Users', and 'Events'. The 'SMTP Notification Handler' section has an 'Enabled' checkbox. Below it is a 'Message' text area with a 'Maximum of 512 characters allowed' note, and 'From' and 'Subject' input fields. There is also an 'Attach JPEG Snapshot' checkbox. The 'SMTP Server' section includes 'Host Address', 'Port' (set to 25), 'Username', and 'Password' fields, with an 'Authentication' dropdown set to 'NO\_AUTH'. The 'E-mail Address List' section contains a table with columns for 'Enable', 'No.', 'Address', 'Motion', and 'Sabotage', listing 10 entries. At the bottom are 'Save' and 'Reset' buttons.

Web Viewer

# HELP

Click the <Help> tab to check Web viewer information.

The screenshot shows the 'Help Resources' page in the Pelco Endura web interface. The page is titled 'IP Encoder - NET5501-1-SERIALNO' and includes navigation tabs for 'Live', 'Settings', 'Help', 'Admin', and 'Admin Logout'. The 'Help Resources' section contains the following text: 'For help with this encoder, please consult the following resources.' Under 'Manuals', it states: 'The manuals for this product are available online from the Pelco website, on the resource CD that came with your encoder, or in printed form. The most up-to-date manuals are available on the Pelco website.' It lists two sources: 1. Website and 2. The manuals are also available on the CD that shipped with your encoder. Under 'Contact Us', it says: 'Can't find what you're looking for? Please contact Pelco Product Support either via email or telephone.' It lists two contact methods: 1. E-mail and 2. Telephone: +1 800 289 9100.

# Appendix

---

## PRODUCT SPECIFICATION

---

### SUPPLIED ACCESSORIES

Power Adapter	PoE
Power Cord / AC PLUG	-
Terminal Block	4-pin terminal blocks x 1
Rack Mount / Wall Mount	1, Wall Mount
Rubber Feet	-

### VIDEO / AUDIO

Video Standards	NTSC / PAL	
Video Encoding	H.264, Main profile	
Video Resolutions		
Analog Cameras	NTSC	PAL
D1	720 x 480	720 x 576
4CIF	704 x 480	704 x 576
2CIF	704 x 240	704 x 288
CIF	352 x 240	352 x 288
Video Input	1 BNC video inputs	
Video Output	-	
Audio Input	-	
Audio Format	-	
Sampling Resolution	-	
Sampling Frequency	-	

### PTZ CONTROL

Interface	Two RS-422/RS-485, video in
Protocol	Pelco P and Pelco D

### ALARMS / RELAYS

Alarms In	-
Relays Out	-

### POWER

Power Consumption	
Input Voltage	PoE 802.3af, Class 0
Current	79 mA
Power (Maximum $\pm 5\%$ )	3.792 W



**FRONT PANEL INDICATORS**

Video presence	<b>Not Lit</b> : A camera has not been connected yet <b>Green</b> : Camera video is present at the video in connector <b>Red</b> : Video is no longer present; the camera is not functioning properly
Network status	<b>Off</b> : The unit is not connected to the network <b>Solid amber</b> : The unit is connected to the network using the 100Mbps standard <b>Solid red</b> : The unit is connected to the network using the 10Mbps standard <b>Solid green</b> : The unit is connected to the network using the 1Gbps standard
Pelco badge(power)	The Pelco badge glows blue when the unit has power
Unit status	<b>Green</b> : The unit is functioning normally <b>Red</b> : The unit is in an error condition

**ENVIRONMENTAL**

Operating Temperature	0 to 45°C
Operating Humidity	80% maximum relative humidity, noncondensing

**PHYSICAL**

Dimensions(mm)	56(W) x 104(D) x 32(H)
Unit Weight(Kg)	0.13

# Appendix

## TROUBLESHOOTING (FAQ)

Problem	Action
The product does not turn on in any way.	<ul style="list-style-type: none"><li>• If you use the PoE power, you can verify that you have sufficient power.</li></ul>
No monitoring video is displayed at all.	<ul style="list-style-type: none"><li>• Check whether the video cable of the camera is connected properly.</li><li>• Check the power of the camera.</li><li>• Check the settings of the camera lens.</li></ul>
I failed to connect the PC to the Encoder.	<ul style="list-style-type: none"><li>• Check whether the LAN cable and the hub are connected properly to the Encoder.</li><li>• If the network settings of the Encoder contain DHCP, check the change history of the DHCP server (router).</li><li>• Use Device Utility or Endura Utilities to check if the network settings of the Encoder have changed in any way.</li></ul>
I cannot access the Encoder because I forgot the admin ID and the password.	<ul style="list-style-type: none"><li>• Reset the Encoder to the factory default as instructed on page 13 of the user manual.</li><li>• When the reset is completed, the default access information is: ID:admin and Password:admin.</li></ul>
Access by the Web has failed.	<ul style="list-style-type: none"><li>• Check whether the network cable for Internet connection is properly connected to the LAN port of the product.</li><li>• If the Encoder is connected to the router, use the IP address of the router.</li></ul>
I can access the Web but still no video image is displayed.	<ul style="list-style-type: none"><li>• This may happen when the communications provider or network administrator has blocked the service port of the Encoder.</li><li>• Try to access the Web using the new port numbers.</li></ul>

## PELCO TROUBLESHOOTING CONTACT INFORMATION

If the instructions provided fail to solve your problem, contact Pelco Product Support at 1-800-289-9100 (USA and Canada) or +1-559-292-1981 (international) for assistance. Be sure to have the serial number available when calling.

Do not try to repair the unit yourself. Leave maintenance and repairs to qualified technical personnel only.

# PRODUCT OVERVIEW

Unit : cm (inch)

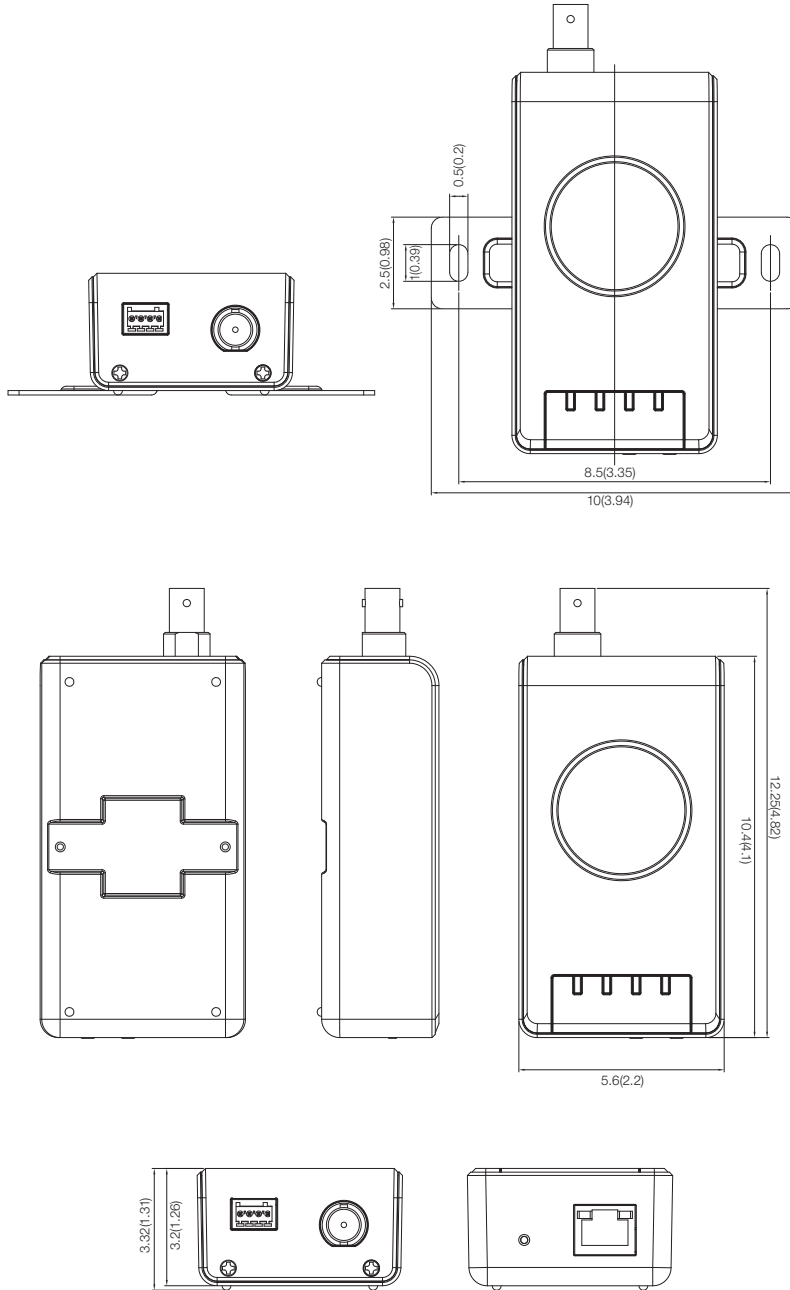

**NOTE :** VALUES IN PARENTHESES ARE INCHES; ALL OTHERS ARE CENTIMETERS.

# OPEN SOURCE LICENSE REPORT ON THE PRODUCT

---

The software included in this product contains copyrighted software that is licensed under the GPL/LGPL.

- GPL Software : linux kernel, busybox, cdrtools, dvd+rw-tools, smartctl, uboot, bash, udev, sysklogd
- LGPL Software : glibc, vmstat, glib, gtk, libESMTP, iconv, gstreamer, pango,
- OpenSSL License : OpenSSL

## GNU GENERAL PUBLIC LICENSE

Version 2, June 1991

Copyright (C) 1989, 1991 Free Software Foundation, Inc.

51 Franklin Street, Fifth Floor, Boston, MA 02110-1301, USA

Everyone is permitted to copy and distribute verbatim copies of this license document, but changing it is not allowed.

### Preamble

The licenses for most software are designed to take away your freedom to share and change it. By contrast, the GNU General Public License is intended to guarantee your freedom to share and change free software to make sure the software is free for all its users. This General Public License applies to most of the Free Software Foundation's software and to any other program whose authors commit to using it. (Some other Free Software Foundation software is covered by the GNU Lesser General Public License instead.) You can apply it to your programs, too.

When we speak of free software, we are referring to freedom, not price. Our General Public Licenses are designed to make sure that you have the freedom to distribute copies of free software (and charge for this service if you wish), that you receive source code or can get it if you want it, that you can change the software or use pieces of it in new free programs; and that you know you can do these things.

To protect your rights, we need to make restrictions that forbid anyone to deny you these rights or to ask you to surrender the rights. These restrictions translate to certain responsibilities for you if you distribute copies of the software, or if you modify it.

For example, if you distribute copies of such a program, whether gratis or for a fee, you must give the recipients all the rights that you have. You must make sure that they, too, receive or can get the source code. And you must show them these terms so they know their rights.

We protect your rights with two steps:

(1) copyright the software, and (2) offer you this license which gives you legal permission to copy, distribute and/or modify the software.

Also, for each author's protection and ours, we want to make certain that everyone understands that there is no warranty for this free software. If the software is modified by someone else and passed on, we want its recipients to know that what they have is not the original, so that any problems introduced by others will not reflect on the original authors' reputations.

Finally, any free program is threatened constantly by software patents. We wish to avoid the danger that redistributors of a free program will individually obtain patent licenses, in effect making the program proprietary. To prevent this, we have made it clear that any patent must be licensed for everyone's free use or not licensed at all. The precise terms and conditions for copying, distribution and modification follow.

## TERMS AND CONDITIONS FOR COPYING, DISTRIBUTION AND MODIFICATION

Version 2, June 1991

Copyright (C) 1989, 1991 Free Software Foundation, Inc.

51 Franklin S

**0.** This License applies to any program or other work which contains a notice placed by the copyright holder saying it may be distributed under the terms of this General Public License. The "Program", below, refers to any such program or work, and a "work based on the Program" means either the Program or any derivative work under copyright law: that is to say, a work containing the Program or a portion of it, either verbatim or with modifications and/or translated into another language. (Hereinafter, translation is included without limitation in the term "modification".) Each licensee is addressed as "you".

Activities other than copying, distribution and modification are not covered by this License; they are outside its scope. The act of running the Program is not restricted, and the output from the Program is covered only if its contents constitute a work based on the Program (independent of having been made by running the Program). Whether that is true depends on what the Program does.

**1.** You may copy and distribute verbatim copies of the Program's source code as you receive it, in any medium, provided that you conspicuously and appropriately publish on each copy an appropriate copyright notice and disclaimer of warranty; keep intact all the notices that refer to this License and to the absence of any warranty; and give any other recipients of the Program a copy of this License along with the Program.

You may charge a fee for the physical act of transferring a copy, and you may at your option offer warranty protection in exchange for a fee.

**2.** You may modify your copy or copies of the Program or any portion of it, thus forming a work based on the Program, and copy and distribute such modifications or work under the terms of Section 1 above, provided that you also meet all of these conditions:

- a) You must cause the modified files to carry prominent notices stating that you changed the files and the date of any change.
- b) You must cause any work that you distribute or publish, that in whole or in part contains or is derived from the Program or any part thereof, to be licensed as a whole at no charge to all third parties under the terms of this License.
- c) If the modified program normally reads commands interactively when run, you must cause it, when started running for such interactive use in the most ordinary way, to print or display an announcement including an appropriate copyright notice and a notice that there is no warranty (or else, saying that you provide a warranty) and that users may redistribute the program under these conditions, and telling the user how to view a copy of this License. (Exception: if the Program itself is interactive but does not normally print such an announcement, your work based on the Program is not required to print an announcement.)

These requirements apply to the modified work as a whole. If identifiable sections of that work are not derived from the Program, and can be reasonably considered independent and separate works in themselves, then this License, and its terms, do not apply to those sections when you distribute them as separate works. But when you distribute the same sections as part of a whole which is a work based on the Program, the distribution of the whole must be on the terms of this License, whose permissions for other licensees extend to the entire whole, and thus to each and every part regardless of who wrote it.

Thus, it is not the intent of this section to claim rights or contest your rights to work written entirely by you; rather, the intent is to exercise the right to control the distribution of derivative or collective works based on the Program.

In addition, mere aggregation of another work not based on the Program with the Program (or with a work based on the Program) on a volume of a storage or distribution medium does not bring the other work under the scope of this License.

**3.** You may copy and distribute the Program (or a work based on it, under Section 2) in object code or executable form under the terms of Sections 1 and 2 above provided that you also do one of the following:

- a) Accompany it with the complete corresponding machine-readable source code, which must be distributed under the terms of Sections 1 and 2 above on a medium customarily used for software interchange; or,
- b) Accompany it with a written offer, valid for at least three years, to give any third party, for a charge no more than your cost of physically performing source distribution, a complete machine-readable copy of the corresponding source code, to be distributed under the terms of Sections 1 and 2 above on a medium customarily used for software interchange; or,

- c) Accompany it with the information you received as to the offer to distribute corresponding source code. (This alternative is allowed only for noncommercial distribution and only if you received the program in object code or executable form with such an offer, in accord with Subsection b above.)

The source code for a work means the preferred form of the work for making modifications to it. For an executable work, complete source code means all the source code for all modules it contains, plus any associated interface definition files, plus the scripts used to control compilation and installation of the executable. However, as a special exception, the source code distributed need not include anything that is normally distributed (in either source or binary form) with the major components (compiler, kernel, and so on) of the operating system on which the executable runs, unless that component itself accompanies the executable.

If distribution of executable or object code is made by offering access to copy from a designated place, then offering equivalent access to copy the source code from the same place counts as distribution of the source code, even though third parties are not compelled to copy the source along with the object code.

4. You may not copy, modify, sublicense, or distribute the Program except as expressly provided under this License. Any attempt otherwise to copy, modify, sublicense or distribute the Program is void, and will automatically terminate your rights under this License. However, parties who have received copies, or rights, from you under this License will not have their licenses terminated so long as such parties remain in full compliance.

5. You are not required to accept this License, since you have not signed it. However, nothing else grants you permission to modify or distribute the Program or its derivative works. These actions are prohibited by law if you do not accept this License. Therefore, by modifying or distributing the Program (or any work based on the Program), you indicate your acceptance of this License to do so, and all its terms and conditions for copying, distributing or modifying the Program or works based on it.

6. Each time you redistribute the Program (or any work based on the Program), the recipient automatically receives a license from the original licensor to copy, distribute or modify the Program subject to these terms and conditions. You may not impose any further restrictions on the recipients' exercise of the rights granted herein. You are not responsible for enforcing compliance by third parties to this License.

7. If, as a consequence of a court judgment or allegation of patent infringement or for any other reason (not limited to patent issues), conditions are imposed on you (whether by court order, agreement or otherwise) that contradict the conditions of this License, they do not excuse you from the conditions of this License. If you cannot distribute so as to satisfy simultaneously your obligations under this License and any other pertinent obligations, then as a consequence you may not distribute the Program at all. For example, if a patent license would not permit royalty-free redistribution of the Program by all those who receive copies directly or indirectly through you, then the only way you could satisfy both it and this License would be to refrain entirely from distribution of the Program.

If any portion of this section is held invalid or unenforceable under any particular circumstance, the balance of the section is intended to apply and the section as a whole is intended to apply in other circumstances.

It is not the purpose of this section to induce you to infringe any patents or other property right claims or to contest validity of any such claims; this section has the sole purpose of protecting the integrity of the free software distribution system, which is implemented by public license practices. Many people have made generous contributions to the wide range of software distributed through that system in reliance on consistent application of that system; it is up to the author/donor to decide if he or she is willing to distribute software through any other system and a licensee cannot impose that choice.

This section is intended to make thoroughly clear what is believed to be a consequence of the rest of this License.

8. If the distribution and/or use of the Program is restricted in certain countries either by patents or by copyrighted interfaces, the original copyright holder who places the Program under this License may add an explicit geographical distribution limitation excluding those countries, so that distribution is permitted only in or among countries not thus excluded. In such case, this License incorporates the limitation as if written in the body of this License.

9. The Free Software Foundation may publish revised and/or new versions of the General Public License from time to time. Such new versions will be similar in spirit to the present version, but may differ in detail to address new problems or concerns.

Each version is given a distinguishing version number. If the Program specifies a version number of this License which applies to it and "any later version", you have the option of following the terms and conditions either of that version or of any later version published by the Free Software Foundation. If the Program does not specify a version number of this License, you may choose any version ever published by the Free Software Foundation.

10. If you wish to incorporate parts of the Program into other free programs whose distribution conditions are different, write to the author to ask for permission. For software which is copyrighted by the Free Software Foundation, write to the Free Software Foundation; we sometimes make exceptions for this. Our decision will be guided by the two goals of preserving the free status of all derivatives of our free software and of promoting the sharing and reuse of software generally.

## NO WARRANTY

11. BECAUSE THE PROGRAM IS LICENSED FREE OF CHARGE, THERE IS NO WARRANTY FOR THE PROGRAM, TO THE EXTENT PERMITTED BY APPLICABLE LAW. EXCEPT WHEN OTHERWISE STATED IN WRITING THE COPYRIGHT HOLDERS AND/OR OTHER PARTIES PROVIDE THE PROGRAM "AS IS" WITHOUT WARRANTY OF ANY KIND, EITHER EXPRESSED OR IMPLIED, INCLUDING, BUT NOT LIMITED TO, THE IMPLIED WARRANTIES OF MERCHANTABILITY AND FITNESS FOR A PARTICULAR PURPOSE. THE ENTIRE RISK AS TO THE QUALITY AND PERFORMANCE OF THE PROGRAM IS WITH YOU. SHOULD THE PROGRAM PROVE DEFECTIVE, YOU ASSUME THE COST OF ALL NECESSARY SERVICING, REPAIR OR CORRECTION.

12. IN NO EVENT UNLESS REQUIRED BY APPLICABLE LAW OR AGREED TO IN WRITING WILL ANY COPYRIGHT HOLDER, OR ANY OTHER PARTY WHO MAY MODIFY AND/OR REDISTRIBUTE THE PROGRAM AS PERMITTED ABOVE, BE LIABLE TO YOU FOR DAMAGES, INCLUDING ANY GENERAL, SPECIAL, INCIDENTAL OR CONSEQUENTIAL DAMAGES ARISING OUT OF THE USE OR INABILITY TO USE THE PROGRAM (INCLUDING BUT NOT LIMITED TO LOSS OF DATA OR DATA BEING RENDERED INACCURATE OR LOSSES SUSTAINED BY YOU OR THIRD PARTIES OR A FAILURE OF THE PROGRAM TO OPERATE WITH ANY OTHER PROGRAMS), EVEN IF SUCH HOLDER OR OTHER PARTY HAS BEEN ADVISED OF THE POSSIBILITY OF SUCH DAMAGES.

## END OF TERMS AND CONDITIONS

### How to Apply These Terms to Your New Programs

If you develop a new program, and you want it to be of the greatest possible use to the public, the best way to achieve this is to make it free software which everyone can redistribute and change under these terms.

To do so, attach the following notices to the program. It is safest to attach them to the start of each source file to most effectively convey the exclusion of warranty; and each file should have at least the "copyright" line and a pointer to where the full notice is found.

one line to give the program's name and an idea of what it does.

Copyright (C) yyyy name of author

This program is free software; you can redistribute it and/or modify it under the terms of the GNU General Public License as published by the Free Software Foundation; either version 2 of the License, or (at your option) any later version.

This program is distributed in the hope that it will be useful, but WITHOUT ANY WARRANTY; without even the implied warranty of MERCHANTABILITY or FITNESS FOR A PARTICULAR PURPOSE. See the GNU General Public License for more details.

You should have received a copy of the GNU General Public License along with this program; if not, write to the Free Software Foundation, Inc., 51 Franklin Street, Fifth Floor, Boston, MA 02110-1301, USA.

Also add information on how to contact you by electronic and paper mail. If the program is interactive, make it output a short notice like this when it starts in an interactive mode:

Gnomovision version 69, Copyright (C) year name of author Gnomovision comes with ABSOLUTELY NO WARRANTY; for details type 'show w'. This is free software, and you are welcome to redistribute it under certain conditions; type 'show c' for details.

The hypothetical commands 'show w' and 'show c' should show the appropriate parts of the General Public License. Of course, the commands you use may be called something other than 'show w' and 'show c'; they could even be mouse-clicks or menu items--whatever suits your program.

You should also get your employer (if you work as a programmer) or your school, if any, to sign a "copyright disclaimer" for the program, if necessary. Here is a sample; alter the names:

Yoyodyne, Inc., hereby disclaims all copyright interest in the program 'Gnomovision' (which makes passes at compilers) written by James Hacker.

signature of Ty Coon, 1 April 1989 Ty Coon, President of Vice This General Public License does not permit incorporating your program into proprietary programs. If your program is a subroutine library, you may consider it more useful to permit linking proprietary applications with the library. If this is what you want to do, use the GNU Lesser General Public License instead of this License.

## GNU GENERAL PUBLIC LICENSE

Version 3, 29 June 2007

Copyright © 2007 Free Software Foundation, Inc. <<http://fsf.org/>>

Everyone is permitted to copy and distribute verbatim copies of this license document, but changing it is not allowed.

### Preamble

The GNU General Public License is a free, copyleft license for software and other kinds of works.

The licenses for most software and other practical works are designed to take away your freedom to share and change the works. By contrast, the GNU General Public License is intended to guarantee your freedom to share and change all versions of a program--to make sure it remains free software for all its users. We, the Free Software Foundation, use the GNU General Public License for most of our software; it applies also to any other work released this way by its authors. You can apply it to your programs, too.

When we speak of free software, we are referring to freedom, not price. Our General Public Licenses are designed to make sure that you have the freedom to distribute copies of free software (and charge for them if you wish), that you receive source code or can get it if you want it, that you can change the software or use pieces of it in new free programs, and that you know you can do these things.

To protect your rights, we need to prevent others from denying you these rights or asking you to surrender the rights. Therefore, you have certain responsibilities if you distribute copies of the software, or if you modify it: responsibilities to respect the freedom of others.

For example, if you distribute copies of such a program, whether gratis or for a fee, you must pass on to the recipients the same freedoms that you received. You must make sure that they, too, receive or can get the source code. And you must show them these terms so they know their rights.

Developers that use the GNU GPL protect your rights with two steps: (1) assert copyright on the software, and (2) offer you this License giving you legal permission to copy, distribute and/or modify it.

For the developers' and authors' protection, the GPL clearly explains that there is no warranty for this free software. For both users' and authors' sake, the GPL requires that modified versions be marked as changed, so that their problems will not be attributed erroneously to authors of previous versions.

Some devices are designed to deny users access to install or run modified versions of the software inside them, although the manufacturer can do so. This is fundamentally incompatible with the aim of protecting users' freedom to change the software. The systematic pattern of such abuse occurs in the area of products for individuals to use, which is precisely where it is most unacceptable. Therefore, we have designed this version of the GPL to prohibit the practice for those products. If such problems arise substantially in other domains, we stand ready to extend this provision to those domains in future versions of the GPL, as needed to protect the freedom of users.

Finally, every program is threatened constantly by software patents. States should not allow patents to restrict development and use of software on general-purpose computers, but in those that do, we wish to avoid the special danger that patents applied to a free program could make it effectively proprietary. To prevent this, the GPL assures that patents cannot be used to render the program non-free.

The precise terms and conditions for copying, distribution and modification follow.

## TERMS AND CONDITIONS

### 0. Definitions.

"This License" refers to version 3 of the GNU General Public License.

"Copyright" also means copyright-like laws that apply to other kinds of works, such as semiconductor masks.

"The Program" refers to any copyrightable work licensed under this License. Each licensee is addressed as "you". "Licensees" and "recipients" may be individuals or organizations.

To "modify" a work means to copy from or adapt all or part of the work in a fashion requiring copyright permission, other than the making of an exact copy. The resulting work is called a "modified version" of the earlier work or a work "based on" the earlier work.

A "covered work" means either the unmodified Program or a work based on the Program.

To "propagate" a work means to do anything with it that, without permission, would make you directly or secondarily liable for infringement under applicable copyright law, except executing it on a computer or modifying a private copy. Propagation includes copying, distribution (with or without modification), making available to the public, and in some countries other activities as well.

To "convey" a work means any kind of propagation that enables other parties to make or receive copies. Mere interaction with a user through a computer network, with no transfer of a copy, is not conveying.

An interactive user interface displays "Appropriate Legal Notices" to the extent that it includes a convenient and prominently visible feature that (1) displays an appropriate copyright notice, and (2) tells the user that there is no warranty for the work (except to the extent that warranties are provided), that licensees may convey the work under this License, and how to view a copy of this License. If the interface presents a list of user commands or options, such as a menu, a prominent item in the list meets this criterion.

### 1. Source Code.

The "source code" for a work means the preferred form of the work for making modifications to it. "Object code" means any non-source form of a work.

A "Standard Interface" means an interface that either is an official standard defined by a recognized standards body, or, in the case of interfaces specified for a particular programming language, one that is widely used among developers working in that language.

The "System Libraries" of an executable work include anything, other than the work as a whole, that (a) is included in the normal form of packaging a Major Component, but which is not part of that Major Component, and (b) serves only to enable use of the work with that Major Component, or to implement a Standard Interface for which an implementation is available to the public in source code form. A "Major Component", in this context, means a major essential component (kernel, window system, and so on) of the specific operating system (if any) on which the executable work runs, or a compiler used to produce the work, or an object code interpreter used to run it.

The "Corresponding Source" for a work in object code form means all the source code needed to generate, install, and (for an executable work) run the object code and to modify the work, including scripts to control those activities. However, it does not include the work's System Libraries, or general-purpose tools or generally available free programs which are used unmodified in performing those activities but which are not part of the work. For example, Corresponding Source includes interface definition files associated with source files for the work, and the source code for shared libraries and dynamically linked subprograms that the work is specifically designed to require, such as by intimate data communication or control flow between those subprograms and other parts of the work.

The Corresponding Source need not include anything that users can regenerate automatically from other parts of the Corresponding Source.

The Corresponding Source for a work in source code form is that same work.

## 2. Basic Permissions.

All rights granted under this License are granted for the term of copyright on the Program, and are irrevocable provided the stated conditions are met. This License explicitly affirms your unlimited permission to run the unmodified Program. The output from running a covered work is covered by this License only if the output, given its content, constitutes a covered work. This License acknowledges your rights of fair use or other equivalent, as provided by copyright law.

You may make, run and propagate covered works that you do not convey, without conditions so long as your license otherwise remains in force. You may convey covered works to others for the sole purpose of having them make modifications exclusively for you, or provide you with facilities for running those works, provided that you comply with the terms of this License in conveying all material for which you do not control copyright. Those thus making or running the covered works for you must do so exclusively on your behalf, under your direction and control, on terms that prohibit them from making any copies of your copyrighted material outside their relationship with you.

Conveying under any other circumstances is permitted solely under the conditions stated below. Sublicensing is not allowed; section 10 makes it unnecessary.

## 3. Protecting Users' Legal Rights From Anti-Circumvention Law.

No covered work shall be deemed part of an effective technological measure under any applicable law fulfilling obligations under article 11 of the WIPO copyright treaty adopted on 20 December 1996, or similar laws prohibiting or restricting circumvention of such measures.

When you convey a covered work, you waive any legal power to forbid circumvention of technological measures to the extent such circumvention is effected by exercising rights under this License with respect to the covered work, and you disclaim any intention to limit operation or modification of the work as a means of enforcing, against the work's users, your or third parties' legal rights to forbid circumvention of technological measures.

## 4. Conveying Verbatim Copies.

You may convey verbatim copies of the Program's source code as you receive it, in any medium, provided that you conspicuously and appropriately publish on each copy an appropriate copyright notice; keep intact all notices stating that this License and any non-permissive terms added in accord with section 7 apply to the code; keep intact all notices of the absence of any warranty; and give all recipients a copy of this License along with the Program.

You may charge any price or no price for each copy that you convey, and you may offer support or warranty protection for a fee.

## 5. Conveying Modified Source Versions.

You may convey a work based on the Program, or the modifications to produce it from the Program, in the form of source code under the terms of section 4, provided that you also meet all of these conditions:

- a) The work must carry prominent notices stating that you modified it, and giving a relevant date.
- b) The work must carry prominent notices stating that it is released under this License and any conditions added under section 7. This requirement modifies the requirement in section 4 to "keep intact all notices".
- c) You must license the entire work, as a whole, under this License to anyone who comes into possession of a copy. This License will therefore apply, along with any applicable section 7 additional terms, to the whole of the work, and all its parts, regardless of how they are packaged. This License gives no permission to license the work in any other way, but it does not invalidate such permission if you have separately received it.
- d) If the work has interactive user interfaces, each must display Appropriate Legal Notices; however, if the Program has interactive interfaces that do not display Appropriate Legal Notices, your work need not make them do so.

A compilation of a covered work with other separate and independent works, which are not by their nature extensions of the covered work, and which are not combined with it such as to form a larger program, in or on a volume of a storage or distribution medium, is called an "aggregate" if the compilation and its resulting copyright are not used to limit the access or legal rights of the compilation's users beyond what the individual works permit. Inclusion of a covered work in an aggregate does not cause this License to apply to the other parts of the aggregate.

## 6. Conveying Non-Source Forms.

You may convey a covered work in object code form under the terms of sections 4 and 5, provided that you also convey the machine-readable Corresponding Source under the terms of this License, in one of these ways:

- a) Convey the object code in, or embodied in, a physical product (including a physical distribution medium), accompanied by the Corresponding Source fixed on a durable physical medium customarily used for software interchange.
- b) Convey the object code in, or embodied in, a physical product (including a physical distribution medium), accompanied by a written offer, valid for at least three years and valid for as long as you offer spare parts or customer support for that product model, to give anyone who possesses the object code either (1) a copy of the Corresponding Source for all the software in the product that is covered by this License, on a durable physical medium customarily used for software interchange, for a price no more than your reasonable cost of physically performing this conveying of source, or (2) access to copy the Corresponding Source from a network server at no charge.
- c) Convey individual copies of the object code with a copy of the written offer to provide the Corresponding Source. This alternative is allowed only occasionally and noncommercially, and only if you received the object code with such an offer, in accord with subsection 6b.



- d) Convey the object code by offering access from a designated place (gratis or for a charge), and offer equivalent access to the Corresponding Source in the same way through the same place at no further charge. You need not require recipients to copy the Corresponding Source along with the object code. If the place to copy the object code is a network server, the Corresponding Source may be on a different server (operated by you or a third party) that supports equivalent copying facilities, provided you maintain clear directions next to the object code saying where to find the Corresponding Source. Regardless of what server hosts the Corresponding Source, you remain obligated to ensure that it is available for as long as needed to satisfy these requirements.
- e) Convey the object code using peer-to-peer transmission, provided you inform other peers where the object code and Corresponding Source of the work are being offered to the general public at no charge under subsection 6d.

A separable portion of the object code, whose source code is excluded from the Corresponding Source as a System Library, need not be included in conveying the object code work.

A "User Product" is either (1) a "consumer product", which means any tangible personal property which is normally used for personal, family, or household purposes, or (2) anything designed or sold for incorporation into a dwelling. In determining whether a product is a consumer product, doubtful cases shall be resolved in favor of coverage. For a particular product received by a particular user, "normally used" refers to a typical or common use of that class of product, regardless of the status of the particular user or of the way in which the particular user actually uses, or expects or is expected to use, the product. A product is a consumer product regardless of whether the product has substantial commercial, industrial or non-consumer uses, unless such uses represent the only significant mode of use of the product.

"Installation Information" for a User Product means any methods, procedures, authorization keys, or other information required to install and execute modified versions of a covered work in that User Product from a modified version of its Corresponding Source. The information must suffice to ensure that the continued functioning of the modified object code is in no case prevented or interfered with solely because modification has been made.

If you convey an object code work under this section in, or with, or specifically for use in, a User Product, and the conveying occurs as part of a transaction in which the right of possession and use of the User Product is transferred to the recipient in perpetuity or for a fixed term (regardless of how the transaction is characterized), the Corresponding Source conveyed under this section must be accompanied by the Installation Information. But this requirement does not apply if neither you nor any third party retains the ability to install modified object code on the User Product (for example, the work has been installed in ROM).

The requirement to provide Installation Information does not include a requirement to continue to provide support service, warranty, or updates for a work that has been modified or installed by the recipient, or for the User Product in which it has been modified or installed. Access to a network may be denied when the modification itself materially and adversely affects the operation of the network or violates the rules and protocols for communication across the network.

Corresponding Source conveyed, and Installation Information provided, in accord with this section must be in a format that is publicly documented (and with an implementation available to the public in source code form), and must require no special password or key for unpacking, reading or copying.

## 7. Additional Terms.

"Additional permissions" are terms that supplement the terms of this License by making exceptions from one or more of its conditions. Additional permissions that are applicable to the entire Program shall be treated as though they were included in this License, to the extent that they are valid under applicable law. If additional permissions apply only to part of the Program, that part may be used separately under those permissions, but the entire Program remains governed by this License without regard to the additional permissions.

When you convey a copy of a covered work, you may at your option remove any additional permissions from that copy, or from any part of it. (Additional permissions may be written to require their own removal in certain cases when you modify the work.) You may place additional permissions on material, added by you to a covered work, for which you have or can give appropriate copyright permission.

Notwithstanding any other provision of this License, for material you add to a covered work, you may (if authorized by the copyright holders of that material) supplement the terms of this License with terms:

- a) Disclaiming warranty or limiting liability differently from the terms of sections 15 and 16 of this License; or
- b) Requiring preservation of specified reasonable legal notices or author attributions in that material or in the Appropriate Legal Notices displayed by works containing it; or
- c) Prohibiting misrepresentation of the origin of that material, or requiring that modified versions of such material be marked in reasonable ways as different from the original version; or
- d) Limiting the use for publicity purposes of names of licensors or authors of the material; or
- e) Declining to grant rights under trademark law for use of some trade names, trademarks, or service marks; or
- f) Requiring indemnification of licensors and authors of that material by anyone who conveys the material (or modified versions of it) with contractual assumptions of liability to the recipient, for any liability that these contractual assumptions directly impose on those licensors and authors.

All other non-permissive additional terms are considered "further restrictions" within the meaning of section 10. If the Program as you received it, or any part of it, contains a notice stating that it is governed by this License along with a term that is a further restriction, you may remove that term. If a license document contains a further restriction but permits relicensing or conveying under this License, you may add to a covered work material governed by the terms of that license document, provided that the further restriction does not survive such relicensing or conveying.

If you add terms to a covered work in accord with this section, you must place, in the relevant source files, a statement of the additional terms that apply to those files, or a notice indicating where to find the applicable terms.

Additional terms, permissive or non-permissive, may be stated in the form of a separately written license, or stated as exceptions; the above requirements apply either way.

## 8. Termination.

You may not propagate or modify a covered work except as expressly provided under this License. Any attempt otherwise to propagate or modify it is void, and will automatically terminate your rights under this License (including any patent licenses granted under the third paragraph of section 11).

However, if you cease all violation of this License, then your license from a particular copyright holder is reinstated (a) provisionally, unless and until the copyright holder explicitly and finally terminates your license, and (b) permanently, if the copyright holder fails to notify you of the violation by some reasonable means prior to 60 days after the cessation.

Moreover, your license from a particular copyright holder is reinstated permanently if the copyright holder notifies you of the violation by some reasonable means, this is the first time you have received notice of violation of this License (for any work) from that copyright holder, and you cure the violation prior to 30 days after your receipt of the notice.

Termination of your rights under this section does not terminate the licenses of parties who have received copies or rights from you under this License. If your rights have been terminated and not permanently reinstated, you do not qualify to receive new licenses for the same material under section 10.



## 9. Acceptance Not Required for Having Copies.

You are not required to accept this License in order to receive or run a copy of the Program. Ancillary propagation of a covered work occurring solely as a consequence of using peer-to-peer transmission to receive a copy likewise does not require acceptance. However, nothing other than this License grants you permission to propagate or modify any covered work. These actions infringe copyright if you do not accept this License. Therefore, by modifying or propagating a covered work, you indicate your acceptance of this License to do so.

## 10. Automatic Licensing of Downstream Recipients.

Each time you convey a covered work, the recipient automatically receives a license from the original licensors, to run, modify and propagate that work, subject to this License. You are not responsible for enforcing compliance by third parties with this License.

An "entity transaction" is a transaction transferring control of an organization, or substantially all assets of one, or subdividing an organization, or merging organizations. If propagation of a covered work results from an entity transaction, each party to that transaction who receives a copy of the work also receives whatever licenses to the work the party's predecessor in interest had or could give under the previous paragraph, plus a right to possession of the Corresponding Source of the work from the predecessor in interest, if the predecessor has it or can get it with reasonable efforts.

You may not impose any further restrictions on the exercise of the rights granted or affirmed under this License. For example, you may not impose a license fee, royalty, or other charge for exercise of rights granted under this License, and you may not initiate litigation (including a cross-claim or counterclaim in a lawsuit) alleging that any patent claim is infringed by making, using, selling, offering for sale, or importing the Program or any portion of it.

## 11. Patents.

A "contributor" is a copyright holder who authorizes use under this License of the Program or a work on which the Program is based. The work thus licensed is called the contributor's "contributor version".

A contributor's "essential patent claims" are all patent claims owned or controlled by the contributor, whether already acquired or hereafter acquired, that would be infringed by some manner, permitted by this License, of making, using, or selling its contributor version, but do not include claims that would be infringed only as a consequence of further modification of the contributor version. For purposes of this definition, "control" includes the right to grant patent sublicenses in a manner consistent with the requirements of this License.

Each contributor grants you a non-exclusive, worldwide, royalty-free patent license under the contributor's essential patent claims, to make, use, sell, offer for sale, import and otherwise run, modify and propagate the contents of its contributor version.

In the following three paragraphs, a "patent license" is any express agreement or commitment, however denominated, not to enforce a patent (such as an express permission to practice a patent or covenant not to sue for patent infringement). To "grant" such a patent license to a party means to make such an agreement or commitment not to enforce a patent against the party.

If you convey a covered work, knowingly relying on a patent license, and the Corresponding Source of the work is not available for anyone to copy, free of charge and under the terms of this License, through a publicly available network server or other readily accessible means, then you must either (1) cause the Corresponding Source to be so available, or (2) arrange to deprive yourself of the benefit of the patent license for this particular work, or (3) arrange, in a manner consistent with the requirements of this License, to extend the patent license to downstream recipients. "Knowingly relying" means you have actual knowledge that, but for the patent license, your conveying the covered work in a country, or your recipient's use of the covered work in a country, would infringe one or more identifiable patents in that country that you have reason to believe are valid.

If, pursuant to or in connection with a single transaction or arrangement, you convey, or propagate by procuring conveyance of, a covered work, and grant a patent license to some of the parties receiving the covered work authorizing them to use, propagate, modify or convey a specific copy of the covered work, then the patent license you grant is automatically extended to all recipients of the covered work and works based on it.

A patent license is "discriminatory" if it does not include within the scope of its coverage, prohibits the exercise of, or is conditioned on the non-exercise of one or more of the rights that are specifically granted under this License. You may not convey a covered work if you are a party to an arrangement with a third party that is in the business of distributing software, under which you make payment to the third party based on the extent of your activity of conveying the work, and under which the third party grants, to any of the parties who would receive the covered work from you, a discriminatory patent license (a) in connection with copies of the covered work conveyed by you (or copies made from those copies), or (b) primarily for and in connection with specific products or compilations that contain the covered work, unless you entered into that arrangement, or that patent license was granted, prior to 28 March 2007.

Nothing in this License shall be construed as excluding or limiting any implied license or other defenses to infringement that may otherwise be available to you under applicable patent law.

## 12. No Surrender of Others' Freedom.

If conditions are imposed on you (whether by court order, agreement or otherwise) that contradict the conditions of this License, they do not excuse you from the conditions of this License. If you cannot convey a covered work so as to satisfy simultaneously your obligations under this License and any other pertinent obligations, then as a consequence you may not convey it at all. For example, if you agree to terms that obligate you to collect a royalty for further conveying from those to whom you convey the Program, the only way you could satisfy both those terms and this License would be to refrain entirely from conveying the Program.

## 13. Use with the GNU Affero General Public License.

Notwithstanding any other provision of this License, you have permission to link or combine any covered work with a work licensed under version 3 of the GNU Affero General Public License into a single combined work, and to convey the resulting work. The terms of this License will continue to apply to the part which is the covered work, but the special requirements of the GNU Affero General Public License, section 13, concerning interaction through a network will apply to the combination as such.

## 14. Revised Versions of this License.

The Free Software Foundation may publish revised and/or new versions of the GNU General Public License from time to time. Such new versions will be similar in spirit to the present version, but may differ in detail to address new problems or concerns.

Each version is given a distinguishing version number. If the Program specifies that a certain numbered version of the GNU General Public License "or any later version" applies to it, you have the option of following the terms and conditions either of that numbered version or of any later version published by the Free Software Foundation. If the Program does not specify a version number of the GNU General Public License, you may choose any version ever published by the Free Software Foundation.

If the Program specifies that a proxy can decide which future versions of the GNU General Public License can be used, that proxy's public statement of acceptance of a version permanently authorizes you to choose that version for the Program.

Later license versions may give you additional or different permissions. However, no additional obligations are imposed on any author or copyright holder as a result of your choosing to follow a later version.

## 15. Disclaimer of Warranty.

THERE IS NO WARRANTY FOR THE PROGRAM, TO THE EXTENT PERMITTED BY APPLICABLE LAW. EXCEPT WHEN OTHERWISE STATED IN WRITING THE COPYRIGHT HOLDERS AND/OR OTHER PARTIES PROVIDE THE PROGRAM "AS IS" WITHOUT WARRANTY OF ANY KIND, EITHER EXPRESSED OR IMPLIED, INCLUDING, BUT NOT LIMITED TO, THE IMPLIED WARRANTIES OF MERCHANTABILITY AND FITNESS FOR A PARTICULAR PURPOSE. THE ENTIRE RISK AS TO THE QUALITY AND PERFORMANCE OF THE PROGRAM IS WITH YOU. SHOULD THE PROGRAM PROVE DEFECTIVE, YOU ASSUME THE COST OF ALL NECESSARY SERVICING, REPAIR OR CORRECTION.

## 16. Limitation of Liability.

IN NO EVENT UNLESS REQUIRED BY APPLICABLE LAW OR AGREED TO IN WRITING WILL ANY COPYRIGHT HOLDER, OR ANY OTHER PARTY WHO MODIFIES AND/OR CONVEYS THE PROGRAM AS PERMITTED ABOVE, BE LIABLE TO YOU FOR DAMAGES, INCLUDING ANY GENERAL, SPECIAL, INCIDENTAL OR CONSEQUENTIAL DAMAGES ARISING OUT OF THE USE OR INABILITY TO USE THE PROGRAM (INCLUDING BUT NOT LIMITED TO LOSS OF DATA OR DATA BEING RENDERED INACCURATE OR LOSSES SUSTAINED BY YOU OR THIRD PARTIES OR A FAILURE OF THE PROGRAM TO OPERATE WITH ANY OTHER PROGRAMS), EVEN IF SUCH HOLDER OR OTHER PARTY HAS BEEN ADVISED OF THE POSSIBILITY OF SUCH DAMAGES.

## 17. Interpretation of Sections 15 and 16.

If the disclaimer of warranty and limitation of liability provided above cannot be given local legal effect according to their terms, reviewing courts shall apply local law that most closely approximates an absolute waiver of all civil liability in connection with the Program, unless a warranty or assumption of liability accompanies a copy of the Program in return for a fee.

END OF TERMS AND CONDITIONS

## GNU LESSER GENERAL PUBLIC LICENSE

Version 2.1, February 1999

Copyright (C) 1991, 1999 Free Software Foundation, Inc.

51 Franklin Street, Fifth Floor, Boston, MA 02110-1301 USA

Everyone is permitted to copy and distribute verbatim copies of this license document, but changing it is not allowed.

[This is the first released version of the Lesser GPL.

It also counts as the successor of the GNU Library Public License, version 2, hence the version number 2.1.]

## Preamble

The licenses for most software are designed to take away your freedom to share and change it. By contrast, the GNU General Public Licenses are intended to guarantee your freedom to share and change free software to make sure the software is free for all its users.

This license, the Lesser General Public License, applies to some specially designated software packages--typically libraries--of the Free Software Foundation and other authors who decide to use it. You can use it too, but we suggest you first think carefully about whether this license or the ordinary General Public License is the better strategy to use in any particular case, based on the explanations below.

When we speak of free software, we are referring to freedom of use, not price. Our General Public Licenses are designed to make sure that you have the freedom to distribute copies of free software (and charge for this service if you wish); that you receive source code or can get it if you want it; that you can change the software and use pieces of it in new free

programs; and that you are informed that you can do these things.

To protect your rights, we need to make restrictions that forbid distributors to deny you these rights or to ask you to surrender these rights. These restrictions translate to certain responsibilities for you if you distribute copies of the library or if you modify it.

For example, if you distribute copies of the library, whether gratis or for a fee, you must give the recipients all the rights that we gave you. You must make sure that they, too, receive or can get the source code. If you link other code with the library, you must provide complete object files to the recipients, so that they can relink them with the library after making changes to the library and recompiling it. And you must show them these terms so they know their rights.

We protect your rights with a two-step method: (1) we copyright the library, and (2) we offer you this license, which gives you legal permission to copy, distribute and/or modify the library.

To protect each distributor, we want to make it very clear that there is no warranty for the free library. Also, if the library is modified by someone else and passed on, the recipients should know that what they have is not the original version, so that the original author's reputation will not be affected by problems that might be introduced by others.

Finally, software patents pose a constant threat to the existence of any free program. We wish to make sure that a company cannot effectively restrict the users of a free program by obtaining a restrictive license from a patent holder. Therefore, we insist that any patent license obtained for a version of the library must be consistent with the full freedom of use specified in this license.

Most GNU software, including some libraries, is covered by the ordinary GNU General Public License. This license, the GNU Lesser General Public License, applies to certain designated libraries, and is quite different from the ordinary General Public License. We use this license for certain libraries in order to permit linking those libraries into non-free programs.

When a program is linked with a library, whether statically or using a shared library, the combination of the two is legally speaking a combined work, a derivative of the original library. The ordinary General Public License therefore permits such linking only if the entire combination fits its criteria of freedom. The Lesser General Public License permits more lax criteria for linking other code with the library.

We call this license the "Lesser" General Public License because it does Less to protect the user's freedom than the ordinary General Public License. It also provides other free software developers Less of an advantage over competing non-free programs. These disadvantages are the reason we use the ordinary General Public License for many libraries. However, the Lesser license provides advantages in certain special circumstances.

For example, on rare occasions, there may be a special need to encourage the widest possible use of a certain library, so that it becomes a de-facto standard. To achieve this, non-free programs must be allowed to use the library. A more frequent case is that a free library does the same job as widely used non-free libraries. In this case, there is little to gain by limiting the free library to free software only, so we use the Lesser General Public License.

In other cases, permission to use a particular library in non-free programs enables a greater number of people to use a large body of free software. For example, permission to use the GNU C Library in non-free programs enables many more people to use the whole GNU operating system, as well as its variant, the GNU/Linux operating system.

Although the Lesser General Public License is Less protective of the users' freedom, it does ensure that the user of a program that is linked with the Library has the freedom and the wherewithal to run that program using a modified version of the Library.

The precise terms and conditions for copying, distribution and modification follow. Pay close attention to the difference between a "work based on the library" and a "work that uses the library". The former contains code derived from the library, whereas the latter must be combined with the library in order to run.

## TERMS AND CONDITIONS FOR COPYING, DISTRIBUTION AND MODIFICATION

**0.** This License Agreement applies to any software library or other program which contains a notice placed by the copyright holder or other authorized party saying it may be distributed under the terms of this Lesser General Public License (also called "this License"). Each licensee is addressed as "you".

A "library" means a collection of software functions and/or data prepared so as to be conveniently linked with application programs (which use some of those functions and data) to form executables.

The "Library", below, refers to any such software library or work which has been distributed under these terms. A "work based on the Library" means either the Library or any derivative work under copyright law: that is to say, a work containing the Library or a portion of it, either verbatim or with modifications and/or translated straightforwardly into another language. (Hereinafter, translation is included without limitation in the term "modification".)

"Source code" for a work means the preferred form of the work for making modifications to it. For a library, complete source code means all the source code for all modules it contains, plus any associated interface definition files, plus the scripts used to control compilation and installation of the library.

Activities other than copying, distribution and modification are not covered by this License; they are outside its scope. The act of running a program using the Library is not restricted, and output from such a program is covered only if its contents constitute a work based on the Library (independent of the use of the Library in a tool for writing it). Whether that is true depends on what the Library does and what the program that uses the Library does.

**1.** You may copy and distribute verbatim copies of the Library's complete source code as you receive it, in any medium, provided that you conspicuously and appropriately publish on each copy an appropriate copyright notice and disclaimer of warranty; keep intact all the notices that refer to this License and to the absence of any warranty; and distribute a copy of this License along with the Library.

You may charge a fee for the physical act of transferring a copy, and you may at your option offer warranty protection in exchange for a fee.

**2.** You may modify your copy or copies of the Library or any portion of it, thus forming a work based on the Library, and copy and distribute such modifications or work under the terms of Section 1 above, provided that you also meet all of these conditions:

- a) The modified work must itself be a software library.
- b) You must cause the files modified to carry prominent notices stating that you changed the files and the date of any change.
- c) You must cause the whole of the work to be licensed at no charge to all third parties under the terms of this License.
- d) If a facility in the modified Library refers to a function or a table of data to be supplied by an application program that uses the facility, other than as an argument passed when the facility is invoked, then you must make a good faith effort to ensure that, in the event an application does not supply such function or table, the facility still operates, and performs whatever part of its purpose remains meaningful.

(For example, a function in a library to compute square roots has a purpose that is entirely well-defined independent of the application. Therefore, Subsection 2d requires that any application-supplied function or table used by this function must be optional: if the application does not supply it, the square root function must still compute square roots.)

These requirements apply to the modified work as a whole. If identifiable sections of that work are not derived from the Library, and can be reasonably considered independent and separate works in themselves, then this License, and its terms, do not apply to those sections when you distribute them as separate works. But when you distribute the same sections as part of a whole which is a work based on the Library, the distribution of the whole must be on the terms of this License, whose permissions for other licensees extend to the entire whole, and thus to each and every part regardless of who wrote it.

Thus, it is not the intent of this section to claim rights or contest your rights to work written entirely by you; rather, the intent is to exercise the right to control the distribution of derivative or collective works based on the Library.

In addition, mere aggregation of another work not based on the Library with the Library (or with a work based on the Library) on a volume of a storage or distribution medium does not bring the other work under the scope of this License.

**3.** You may opt to apply the terms of the ordinary GNU General Public License instead of this License to a given copy of the Library. To do this, you must alter all the notices that refer to this License, so that they refer to

the ordinary GNU General Public License, version 2, instead of to this License. (If a newer version than version 2 of the ordinary GNU General Public License has appeared, then you can specify that version instead if you wish.) Do not make any other change in these notices.

Once this change is made in a given copy, it is irreversible for that copy, so the ordinary GNU General Public License applies to all subsequent copies and derivative works made from that copy.

This option is useful when you wish to copy part of the code of the Library into a program that is not a library.

**4.** You may copy and distribute the Library (or a portion or derivative of it, under Section 2) in object code or executable form under the terms of Sections 1 and 2 above provided that you accompany it with the complete corresponding machine-readable source code, which must be distributed under the terms of Sections 1 and 2 above on a medium customarily used for software interchange.

If distribution of object code is made by offering access to copy from a designated place, then offering equivalent access to copy the source code from the same place satisfies the requirement to distribute the source code, even though third parties are not compelled to copy the source along with the object code.

**5.** A program that contains no derivative of any portion of the Library, but is designed to work with the Library by being compiled or linked with it, is called a "work that uses the Library". Such a work, in isolation, is not a derivative work of the Library, and therefore falls outside the scope of this License.

However, linking a "work that uses the Library" with the Library creates an executable that is a derivative of the Library (because it contains portions of the Library), rather than a "work that uses the library". The executable is therefore covered by this License. Section 6 states terms for distribution of such executables.

When a "work that uses the Library" uses material from a header file that is part of the Library, the object code for the work may be a derivative work of the Library even though the source code is not. Whether this is true is especially significant if the work can be linked without the Library, or if the work is itself a library. The threshold for this to be true is not precisely defined by law.

If such an object file uses only numerical parameters, data structure layouts and accessors, and small macros and small inline functions (ten lines or less in length), then the use of the object file is unrestricted, regardless of whether it is legally a derivative work. (Executables containing this object code plus portions of the Library will still fall under Section 6.)

Otherwise, if the work is a derivative of the Library, you may distribute the object code for the work under the terms of Section 6. Any executables containing that work also fall under Section 6, whether or not they are linked directly with the Library itself.

**6.** As an exception to the Sections above, you may also combine or link a "work that uses the Library" with the Library to produce a work containing portions of the Library, and distribute that work under terms of your choice, provided that the terms permit modification of the work for the customer's own use and reverse engineering for debugging such modifications.

You must give prominent notice with each copy of the work that the Library is used in it and that the Library and its use are covered by this License. You must supply a copy of this License. If the work during execution displays copyright notices, you must include the copyright notice for the Library among them, as well as a reference directing the user to the copy of this License. Also, you must do one of these things:

- a) Accompany the work with the complete corresponding machine-readable source code for the Library including whatever changes were used in the work (which must be distributed under Sections 1 and 2 above); and, if the work is an executable linked with the Library, with the complete machine readable "work that uses the Library", as object code and/or source code, so that the user can modify the Library and then relink to produce a modified executable containing the modified Library. (It is understood that the user who changes the contents of definitions files in the Library will not necessarily be able to recompile the application to use the modified definitions.)

- b) Use a suitable shared library mechanism for linking with the Library. A suitable mechanism is one that (1) uses at run time a copy of the library already present on the user's computer system, rather than copying library functions into the executable, and (2) will operate properly with a modified version of the library, if the user installs one, as long as the modified version is interface-compatible with the version that the work was made with.
- c) Accompany the work with a written offer, valid for at least three years, to give the same user the materials specified in Subsection 6a, above, for a charge no more than the cost of performing this distribution.
- d) If distribution of the work is made by offering access to copy from a designated place, offer equivalent access to copy the above specified materials from the same place.
- e) Verify that the user has already received a copy of these materials or that you have already sent this user a copy.

For an executable, the required form of the "work that uses the Library" must include any data and utility programs needed for reproducing the executable from it. However, as a special exception, the materials to be distributed need not include anything that is normally distributed (in either source or binary form) with the major components (compiler, kernel, and so on) of the operating system on which the executable runs, unless that component itself accompanies the executable.

It may happen that this requirement contradicts the license restrictions of other proprietary libraries that do not normally accompany the operating system. Such a contradiction means you cannot use both them and the Library together in an executable that you distribute.

**7.** You may place library facilities that are a work based on the Library side-by-side in a single library together with other library facilities not covered by this License, and distribute such a combined library, provided that the separate distribution of the work based on the Library and of the other library facilities is otherwise permitted, and provided that you do these two things:

- a) Accompany the combined library with a copy of the same work based on the Library, uncombined with any other library facilities. This must be distributed under the terms of the Sections above.
- b) Give prominent notice with the combined library of the fact that part of it is a work based on the Library, and explaining where to find the accompanying uncombined form of the same work.

**8.** You may not copy, modify, sublicense, link with, or distribute the Library except as expressly provided under this License. Any attempt otherwise to copy, modify, sublicense, link with, or distribute the Library is void, and will automatically terminate your rights under this License. However, parties who have received copies, or rights, from you under this License will not have their licenses terminated so long as such parties remain in full compliance.

**9.** You are not required to accept this License, since you have not signed it. However, nothing else grants you permission to modify or distribute the Library or its derivative works. These actions are prohibited by law if you do not accept this License. Therefore, by modifying or distributing the Library (or any work based on the Library), you indicate your acceptance of this License to do so, and all its terms and conditions for copying, distributing or modifying the Library or works based on it.

**10.** Each time you redistribute the Library (or any work based on the Library), the recipient automatically receives a license from the original licensor to copy, distribute, link with or modify the Library subject to these terms and conditions. You may not impose any further restrictions on the recipients' exercise of the rights granted herein. You are not responsible for enforcing compliance by third parties with this License.

**11.** If, as a consequence of a court judgment or allegation of patent infringement or for any other reason (not limited to patent issues), conditions are imposed on you (whether by court order, agreement or otherwise) that contradict the conditions of this License, they do not excuse you from the conditions of this License. If you cannot distribute so as to satisfy simultaneously your obligations under this License and any other pertinent obligations, then as a consequence you may not distribute

the Library at all. For example, if a patent license would not permit royalty free redistribution of the Library by all those who receive copies directly or indirectly through you, then the only way you could satisfy both it and this License would be to refrain entirely from distribution of the Library.

If any portion of this section is held invalid or unenforceable under any particular circumstance, the balance of the section is intended to apply, and the section as a whole is intended to apply in other circumstances.

It is not the purpose of this section to induce you to infringe any patents or other property right claims or to contest validity of any such claims; this section has the sole purpose of protecting the integrity of the free software distribution system which is implemented by public license practices. Many people have made generous contributions to the wide range of software distributed through that system in reliance on consistent application of that system; it is up to the author/donor to decide if he or she is willing to distribute software through any other system and a licensee cannot impose that choice.

This section is intended to make thoroughly clear what is believed to be a consequence of the rest of this License.

**12.** If the distribution and/or use of the Library is restricted in certain countries either by patents or by copyrighted interfaces, the original copyright holder who places the Library under this License may add an explicit geographical distribution limitation excluding those countries, so that distribution is permitted only in or among countries not thus excluded. In such case, this License incorporates the limitation as if written in the body of this License.

**13.** The Free Software Foundation may publish revised and/or new versions of the Lesser General Public License from time to time. Such new versions will be similar in spirit to the present version, but may differ in detail to address new problems or concerns.

Each version is given a distinguishing version number. If the Library specifies a version number of this License which applies to it and "any later version", you have the option of following the terms and conditions either of that version or of any later version published by the Free Software Foundation. If the Library does not specify a license version number, you may choose any version ever published by the Free Software Foundation.

**14.** If you wish to incorporate parts of the Library into other free programs whose distribution conditions are incompatible with these, write to the author to ask for permission. For software which is copyrighted by the Free Software Foundation, write to the Free Software Foundation; we sometimes make exceptions for this. Our decision will be guided by the two goals of preserving the free status of all derivatives of our free software and of promoting the sharing and reuse of software generally.

## NO WARRANTY

**15.** BECAUSE THE LIBRARY IS LICENSED FREE OF CHARGE, THERE IS NO WARRANTY FOR THE LIBRARY, TO THE EXTENT PERMITTED BY APPLICABLE LAW. EXCEPT WHEN OTHERWISE STATED IN WRITING THE COPYRIGHT HOLDERS AND/OR OTHER PARTIES PROVIDE THE LIBRARY "AS IS" WITHOUT WARRANTY OF ANY KIND, EITHER EXPRESSED OR IMPLIED, INCLUDING, BUT NOT LIMITED TO, THE IMPLIED WARRANTIES OF MERCHANTABILITY AND FITNESS FOR A PARTICULAR PURPOSE. THE ENTIRE RISK AS TO THE QUALITY AND PERFORMANCE OF THE LIBRARY IS WITH YOU. SHOULD THE LIBRARY PROVE DEFECTIVE, YOU ASSUME THE COST OF ALL NECESSARY SERVICING, REPAIR OR CORRECTION.

**16.** IN NO EVENT UNLESS REQUIRED BY APPLICABLE LAW OR AGREED TO IN WRITING WILL ANY COPYRIGHT HOLDER, OR ANY OTHER PARTY WHO MAY MODIFY AND/OR REDISTRIBUTE THE LIBRARY AS PERMITTED ABOVE, BE LIABLE TO YOU FOR DAMAGES, INCLUDING ANY GENERAL, SPECIAL, INCIDENTAL OR CONSEQUENTIAL DAMAGES ARISING OUT OF THE USE OR INABILITY TO USE THE LIBRARY (INCLUDING BUT NOT LIMITED TO LOSS OF DATA OR DATA BEING RENDERED INACCURATE OR LOSSES SUSTAINED BY YOU OR THIRD PARTIES OR A FAILURE OF THE LIBRARY TO OPERATE WITH ANY OTHER SOFTWARE), EVEN IF SUCH HOLDER OR OTHER PARTY HAS BEEN ADVISED OF THE POSSIBILITY OF SUCH DAMAGES.



## END OF TERMS AND CONDITIONS

### How to Apply These Terms to Your New Libraries

If you develop a new library, and you want it to be of the greatest possible use to the public, we recommend making it free software that everyone can redistribute and change. You can do so by permitting redistribution under these terms (or, alternatively, under the terms of the ordinary General Public License).

To apply these terms, attach the following notices to the library. It is safest to attach them to the start of each source file to most effectively convey the exclusion of warranty; and each file should have at least the "copyright" line and a pointer to where the full notice is found. one line to give the library's name and an idea of what it does.

Copyright (C) year name of author

This library is free software; you can redistribute it and/or modify it under the terms of the GNU Lesser General Public License as published by the Free Software Foundation; either version 2.1 of the License, or (at your option) any later version.

This library is distributed in the hope that it will be useful, but WITHOUT ANY WARRANTY; without even the implied warranty of MERCHANTABILITY or FITNESS FOR A PARTICULAR PURPOSE. See the GNU Lesser General Public License for more details.

You should have received a copy of the GNU Lesser General Public License along with this library; if not, write to the Free Software Foundation, Inc., 51 Franklin Street, Fifth Floor, Boston, MA 02110-1301 USA Also add information on how to contact you by electronic and paper mail.

You should also get your employer (if you work as a programmer) or your school, if any, to sign a "copyright disclaimer" for the library, if necessary. Here is a sample; alter the names:

Yoyodyne, Inc., hereby disclaims all copyright interest in the library 'Frob' (a library for tweaking knobs) written by James Random Hacker.

signature of Ty Coon, 1 April 1990 Ty Coon, President of Vice.

### OpenSSL LICENSE

Copyright (c) 1998-2006 The OpenSSL Project. All rights reserved. Redistribution and use in source and binary forms, with or without modification, are permitted provided that the following conditions are met:

1. Redistributions of source code must retain the above copyright notice, this list of conditions and the following disclaimer.
2. Redistributions in binary form must reproduce the above copyright notice, this list of conditions and the following disclaimer in the documentation and/or other materials provided with the distribution.
3. All advertising materials mentioning features or use of this software must display the following acknowledgement: "This product includes software developed by the OpenSSL Project for use in the OpenSSL Toolkit. (<http://www.openssl.org/>)"
4. The names "OpenSSL Toolkit" and "OpenSSL Project" must not be used to endorse or promote products derived from this software without prior written permission. For written permission, please contact [openssl-core@openssl.org](mailto:openssl-core@openssl.org).
5. Products derived from this software may not be called "OpenSSL." nor may "OpenSSL." appear in their names without prior written permission of the OpenSSL Project.
6. Redistributions of any form whatsoever must retain the following acknowledgement: "This product includes software developed by the OpenSSL Project for use in the OpenSSL Toolkit (<http://www.openssl.org/>)"

THIS SOFTWARE IS PROVIDED BY THE OpenSSL PROJECT "AS IS" AND ANY EXPRESSED OR IMPLIED WARRANTIES, INCLUDING, BUT NOT LIMITED TO, THE IMPLIED WARRANTIES OF MERCHANTABILITY AND FITNESS FOR A PARTICULAR PURPOSE ARE DISCLAIMED. IN NO EVENT SHALL THE OpenSSL PROJECT OR ITS CONTRIBUTORS BE LIABLE FOR ANY DIRECT, INDIRECT, INCIDENTAL, SPECIAL, EXEMPLARY, OR CONSEQUENTIAL DAMAGES (INCLUDING, BUT NOT LIMITED TO, PROCUREMENT OF SUBSTITUTE GOODS OR SERVICES; LOSS OF USE, DATA, OR PROFITS; OR BUSINESS INTERRUPTION) HOWEVER CAUSED AND ON ANY THEORY OF LIABILITY, WHETHER IN CONTRACT, STRICT LIABILITY, OR TORT (INCLUDING NEGLIGENCE OR OTHERWISE) ARISING IN ANY WAY OUT OF THE USE OF THIS SOFTWARE, EVEN IF ADVISED OF THE POSSIBILITY OF SUCH DAMAGE. This product includes cryptographic software written by Eric Young ([ey@cryptsoft.com](mailto:ey@cryptsoft.com)). This product includes software written by Tim Hudson ([tjh@cryptsoft.com](mailto:tjh@cryptsoft.com)).

### Original SSLeay License

Copyright (C) 1995-1998 Eric Young ([ey@cryptsoft.com](mailto:ey@cryptsoft.com)) All rights reserved. This package is an SSL implementation written by Eric Young ([ey@cryptsoft.com](mailto:ey@cryptsoft.com)). The implementation was written so as to conform with Netscapes SSL. This library is free for commercial and non-commercial use as long as the following conditions are adhered to. The following conditions apply to all code found in this distribution, be it the RC4, RSA, lhash, DES, etc., code; not just the SSL code. The SSL documentation included with this distribution is covered by the same copyright terms except that the holder is Tim Hudson ([tjh@cryptsoft.com](mailto:tjh@cryptsoft.com)).

Copyright remains Eric Young's, and as such any Copyright notices in the code are not to be removed.

If this package is used in a product, Eric Young should be given attribution as the author of the parts of the library used. This can be in the form of a textual message at program startup or in documentation (online or textual) provided with the package. Redistribution and use in source and binary forms, with or without modification, are permitted provided that the following conditions are met:

1. Redistributions of source code must retain the copyright notice, this list of conditions and the following disclaimer.
2. Redistributions in binary form must reproduce the above copyright notice, this list of conditions and the following disclaimer in the documentation and/or other materials provided with the distribution.
3. All advertising materials mentioning features or use of this software must display the following acknowledgement: "This product includes cryptographic software written by Eric Young ([ey@cryptsoft.com](mailto:ey@cryptsoft.com))" The word 'cryptographic' can be left out if the routines from the library being used are not cryptographic related :-).
4. If you include any Windows specific code (or a derivative thereof) from the apps directory (application code) you must include an acknowledgement: "This product includes software written by Tim Hudson ([tjh@cryptsoft.com](mailto:tjh@cryptsoft.com))"

THIS SOFTWARE IS PROVIDED BY ERIC YOUNG "AS IS" AND ANY EXPRESS OR IMPLIED WARRANTIES, INCLUDING, BUT NOT LIMITED TO, THE IMPLIED WARRANTIES OF MERCHANTABILITY AND FITNESS FOR A PARTICULAR PURPOSE ARE DISCLAIMED. IN NO EVENT SHALL THE AUTHOR OR CONTRIBUTORS BE LIABLE FOR ANY DIRECT, INDIRECT, INCIDENTAL, SPECIAL, EXEMPLARY, OR CONSEQUENTIAL DAMAGES (INCLUDING, BUT NOT LIMITED TO, PROCUREMENT OF SUBSTITUTE GOODS OR SERVICES; LOSS OF USE, DATA, OR PROFITS; OR BUSINESS INTERRUPTION) HOWEVER CAUSED AND ON ANY THEORY OF LIABILITY, WHETHER IN CONTRACT, STRICT LIABILITY, OR TORT (INCLUDING NEGLIGENCE OR OTHERWISE) ARISING IN ANY WAY OUT OF THE USE OF THIS SOFTWARE, EVEN IF ADVISED OF THE POSSIBILITY OF SUCH DAMAGE. The licence and distribution terms for any publically available version or derivative of this code cannot be changed. i.e. this code cannot simply be copied and put under another distribution licence [including the GNU Public Licence.



This equipment contains electrical or electronic components that must be recycled properly to comply with Directive 2012/19/EU of the European Union regarding the disposal of waste electrical and electronic equipment (WEEE). Contact your local dealer for procedures for recycling this equipment.



## REVISION HISTORY

Manual #	Date	Comments
C5650M	07/14	Original version
C5650M-A	10/14	Changed power consumption values. Changed the model name(Network Video Encoders → Video Encoder)
C5650M-B	05/15	Changed how to perform factory default.

Pelco, the Pelco logo, and other trademarks associated with Pelco products referred to in this publication are trademarks of Pelco, Inc. or its affiliates.

ONVIF and the ONVIF logo are trademarks of ONVIF Inc. All other product names and services are the property of their respective companies.

Product specification and availability are subject to change without notice.

© Copyright 2014, Pelco, Inc.  
All rights reserved.

***PELCO***

---

**by Schneider Electric**

Pelco by Schneider Electric 3500 Pelco Way Clovis, California 93612-5699 United States

USA & Canada Tel (800) 289-9100 Fax (800) 289-9150

International Tel +1 (559) 292-1981 Fax +1 (559) 348-1120

[www.pelco.com](http://www.pelco.com) [www.pelco.com/community](http://www.pelco.com/community)